



HIERROS
JATIVA

SIMPLE RAILING

BARANDILLA

PERFILES | ACCESORIOS



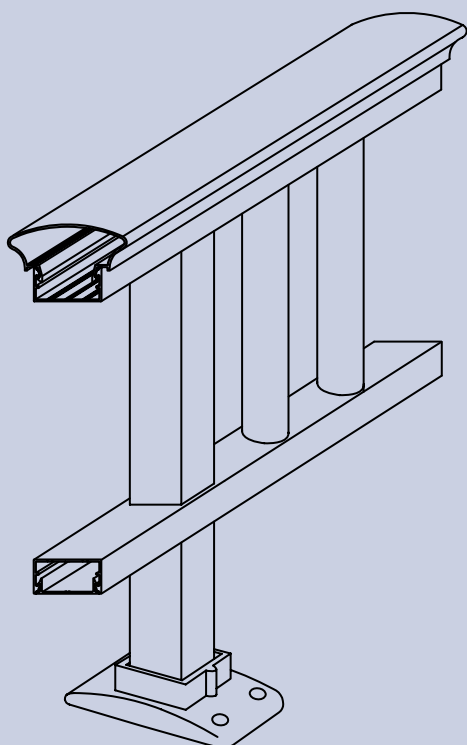

Características técnicas





SECCIÓN MARCO	SECCIÓN HOJA	ALT. GALCE VIDRIO	HUECO VIDRIO MÁX.	ESPESOR NOMINAL
-	-	-	-	1,7

Homologación

AIRE	AGUA	VIENTO	TÉRMICA	ACÚSTICA RW
APTO	APTO	APTO	APTO	APTO

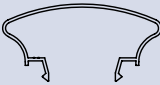

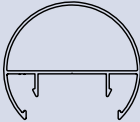
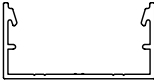
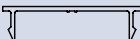
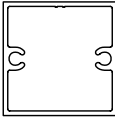
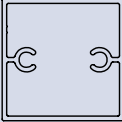
PERFILES | PROFILES

Referencia Reference	Esquema Scheme	Descripción Description
050100		PASAMANOS HANDRAIL
050102		PASAMANOS RECTANGULAR RECTANGULAR HANDRAIL
050103		PASAMANOS REDONDO ROUND HANDRAIL
050110		U PARA BARANDILLA U FOR RAILING
050120		TAPA BARANDILLA CAP FOR RAILING
050130		PILAR DE 30X30 30X30 COLUMN
050131		PILAR DE 40X40 40X40 COLUMN
050160		BARROTE DE 30X15 30X15 BAR
050161		BARROTE OVALADO OVAL BAR



PERFILES | PROFILES

Ref: 050100

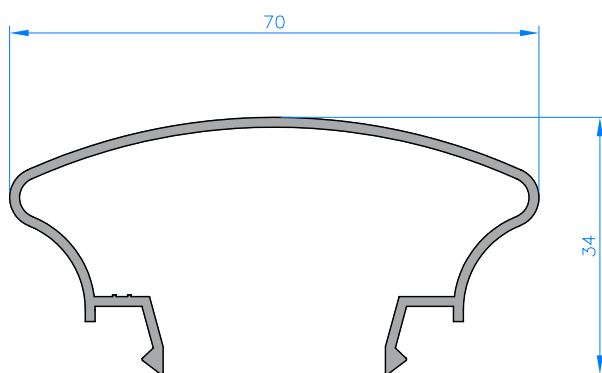

Ref: 050102

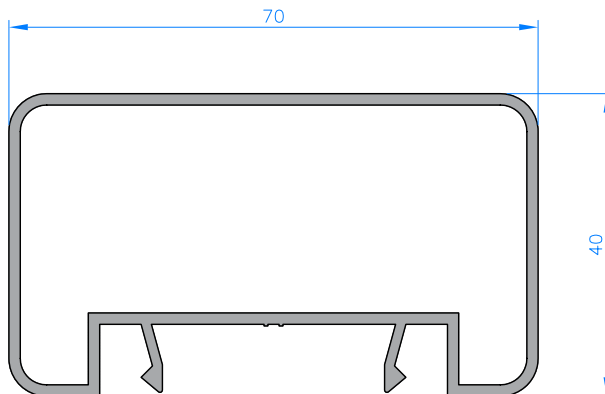

Ref: 050103

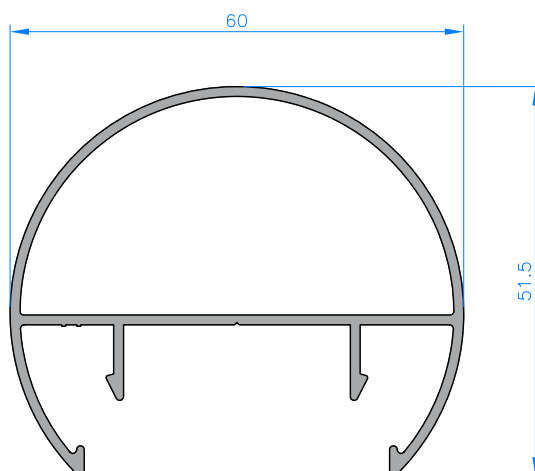



PERFILES | PROFILES

Ref: 050110

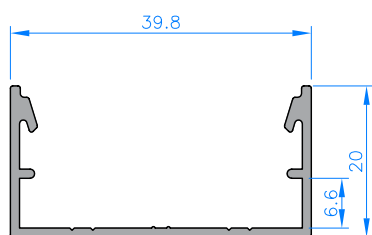

Ref: 050120

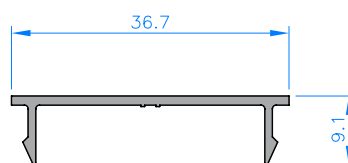

Ref: 050130

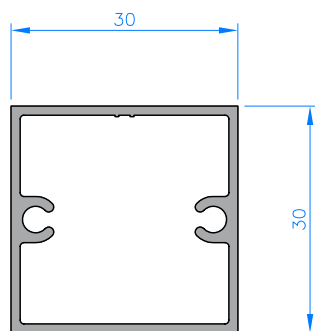

Ref: 050131

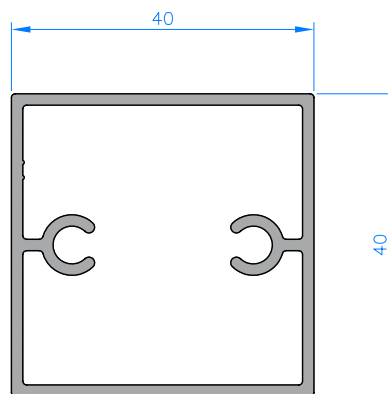

Ref: 050130

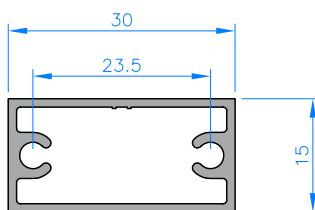

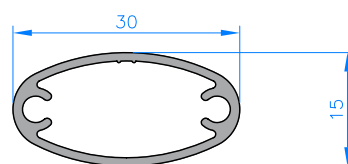

Ref: 050131





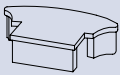
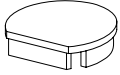
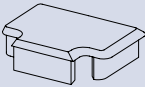
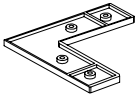
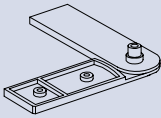
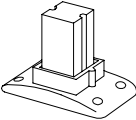
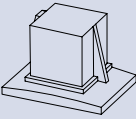
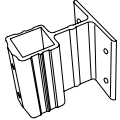
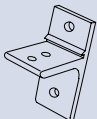





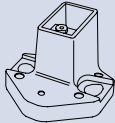

ACCESORIOS | ACCESSORIES

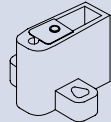
Código Code	Figura Drawing	Descripción Description
5075007		REMATE PASAMANO PARA 050100 HANDRAIL PLUG FOR 050100
5075008		REMATE PASAMANO PARA 050103 HANDRAIL PLUG FOR 050103
5075009		REMATE PASAMANO PARA 050102 HANDRAIL PLUG FOR 050102
5075105		ESCUADRA FIJA DE ALUMINIO ALUMINIUM FIXED BRACKET
5075106		ESCUADRA GRADUABLE GIRATORIA ADJUSTABLE ROTATING BRACKET
5075107		PIE BARANDILLA TUBO 30X30 AUTOR. RAILING FOOT TUBE 30X30 AUTOR.
5075108		PIE BARANDILLA TUBO 40X40 ZAMAC RAILING FOOT TUBE 40X40 ZAMAC
5075109		SOPORTE MONTANTE TUBO 30X30 UPRIGHT SUPPORT TUBE 30X30
5075112		ESCUADRA FIJA BARANDILLA A PARED FIXED BRACKET RAILING TO WALL
5075113		SOPORTE PASAMANOS REDONDO 50 MM. A PARED ROUND SUPPORT 50 MM. TO WALL

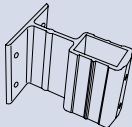

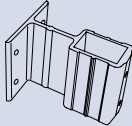
ACCESORIOS | ACCESSORIES

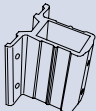
Código Code	Figura Drawing	Descripción Description
5075114		PIE DE BARANDILLA DE 40X20 MM. RAILING FOOT 40X20 MM
5070390		ESCUADRA EN ÁNGULO VARIABLE VARIABLE CORNER JOINT
5070706		ANCLAJE SUELO EXTRUSION ACERO STEEL EXTRUDED FLOOR BASE
5070575		ESCUADRA EN ÁNGULO REGULABLE BARANA CORNER JOINT (ADJUSTABLE)
5070762		SOPORTE MONTANTE 40X20 BARANA SUPPORT WITH ADJUSTMENT GRAINS
5070391		ESCUADRA A COMPAS COMPASS CORNER JOINT
5070761		SOPORTE MONTANTE TUBO 40X20 BARANA SUPPORT WITH ADJUSTMENT GRAINS
5070576		ESCUADRA EN ÁNGULO VARIABLE CORNER JOINT (ADJUSTABLE)
5070763		SOPORTE MONTANTE TUBO 40X20 BARANA SUPPORT WITH ADJUSTMENT GRAINS



**HIERROS
JÁTIVA**

CENTRAL

Pol.Ind. "La Vila" Parcela 5.
46819 / Novetlé / Valencia (Spain)
administracion@hierrosjativa.com

Tel.: 96 227 08 00
Fax.: 96 227 41 63
HIERRO: 678 255 770
ALUMINIO: 678 252 153

.....

DELEGACIÓN ALICANTE

Pol.Ind. I-8, Calle Catral
033330 / Crevillente / Alicante (Spain)
crevillente@hierrosjativa.com

Tel.: 96 540 45 61
Fax.: 96 540 46 45

.....

DELEGACIÓN ZARAGOZA

Alfredo Abad

alfredoberdusan@gmail.com
Tel.: 647 576 092