



CORREDERA ELEVABLE CON ROTURA
LIFT AND SLIDE WITH BREAK

Serie SM-135RT

PERFILES | ACCESORIOS





**HIERROS
JATIVA**

SM-135RT

CORREDERA ELEVABLE CON ROTURA

LIFT AND SLIDE WITH BREAK

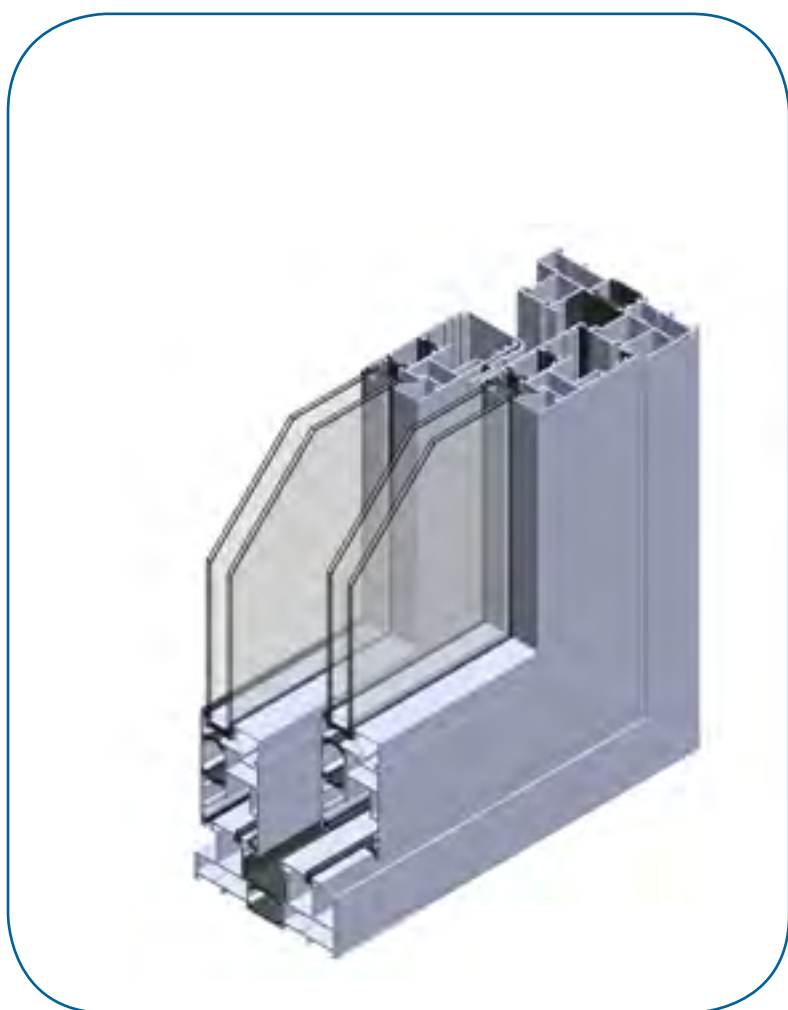

Características técnicas

SECCIÓN MARCO	SECCIÓN HOJA	ALT. GALCE VIDRIO	HUECO VIDRIO MÁX.	ESPESOR
135	56	20	48	1,5

Homologación

AIRE	AGUA	VIENTO	TÉRMICA	ACÚSTICA RW
3	7A	C5	3,50 W/m ² K	32 dB



PERFILES | PROFILES

Referencia Reference	Esquema Scheme	Descripción Description
135010		MARCO SUPERIOR SUPERIOR FRAME
135020		MARCO INFERIOR INFERIOR FRAME
135030		MARCO LATERAL LATERAL FRAME
135001		MARCO PERIMETRAL PERIMETRAL FRAME
135080		MARCO FIJO PERIMETRAL PERIMETRAL FIXED FRAME
135260		HOJA PERIMETRAL PERIMETRAL SASH
135265		SUPLEMENTO RECTO HOJA CENTRAL STRAIGHT COMPLEMENT CENTRAL SASH
135310		MARCO SUPERIOR DE TRES CARRILES SUPERIOR FRAME 3 WAYS
135320		MARCO INFERIOR DE TRES CARRILES INFERIOR FRAME 3 WAYS
135330		MARCO LATERAL DE TRES CARRILES LATERAL FRAME 3 WAYS

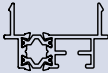
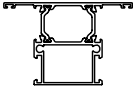

PERFILES | PROFILES

Referencia Reference	Esquema Scheme	Descripción Description
135400		PERFIL CUATRO HOJAS 4 SASH PROFILE
135401		TRAVESAÑO DE HOJA SASH TRANSOM



PERFILES | PROFILES

Ref: 135010

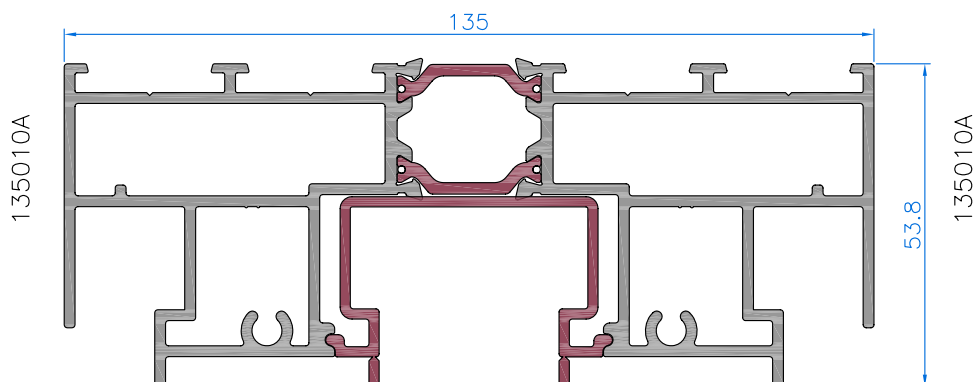

Ref: 135020

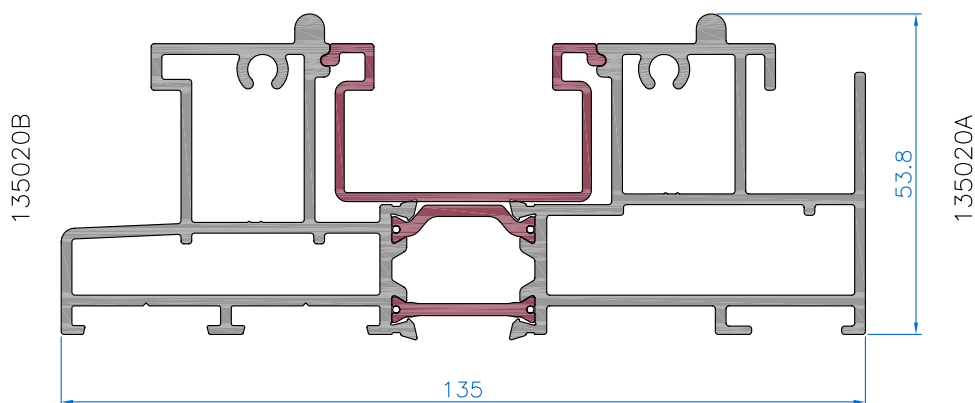

Ref: 135030

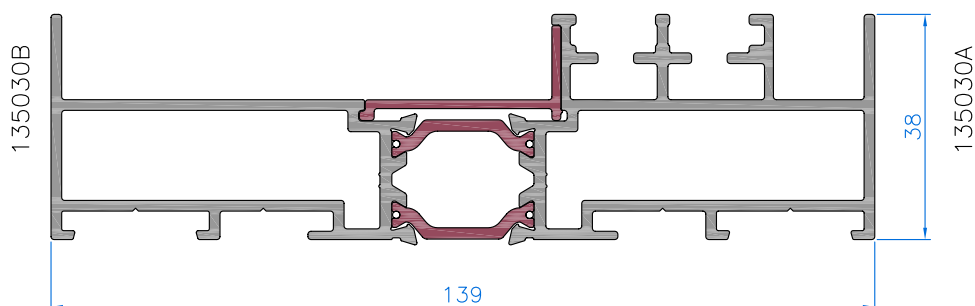



PERFILES | PROFILES

Ref: 135001

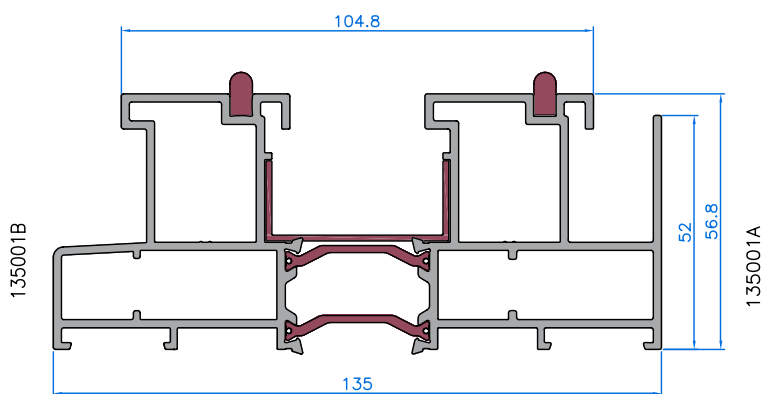

Ref: 135080

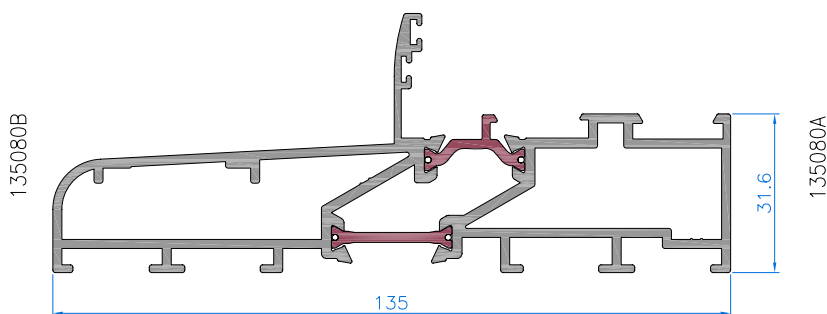

Ref: 135260

135260B

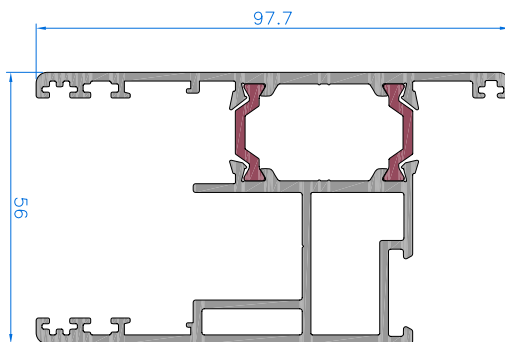

135260A



PERFILES | PROFILES

Ref: 135265

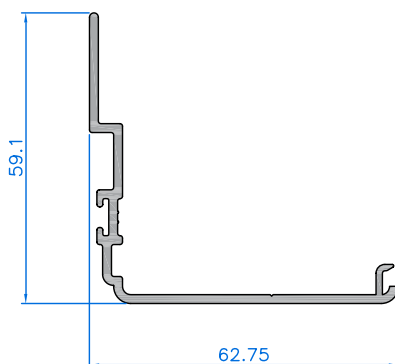

Ref: 135310

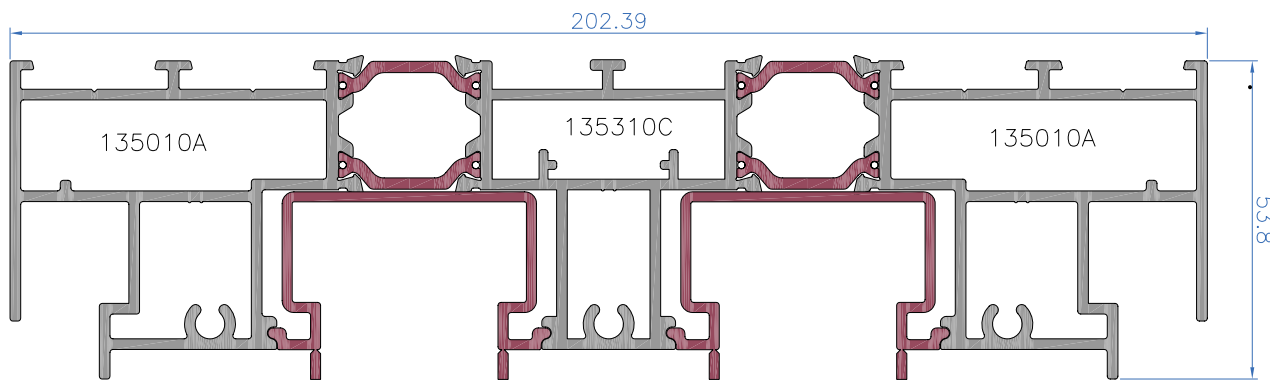

Ref: 135320

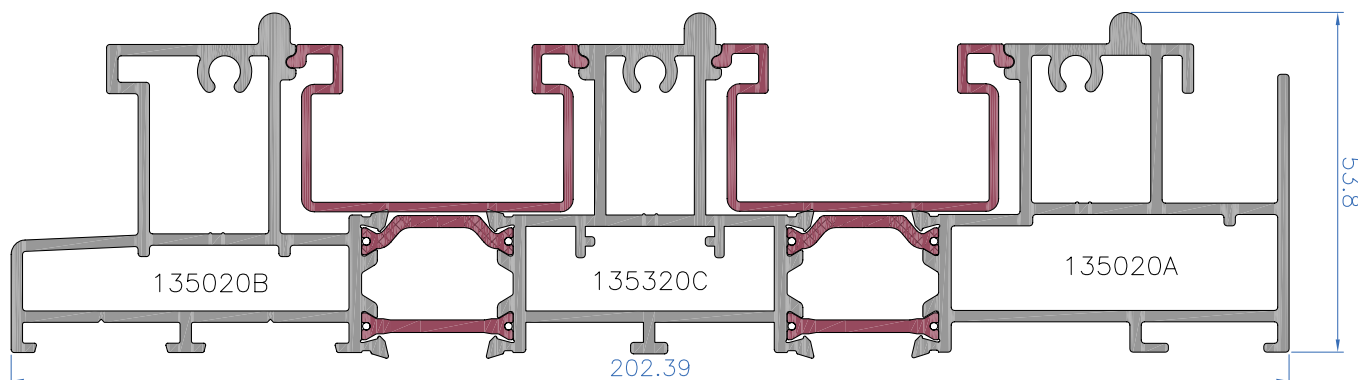



PERFILES | PROFILES

Ref: 135330

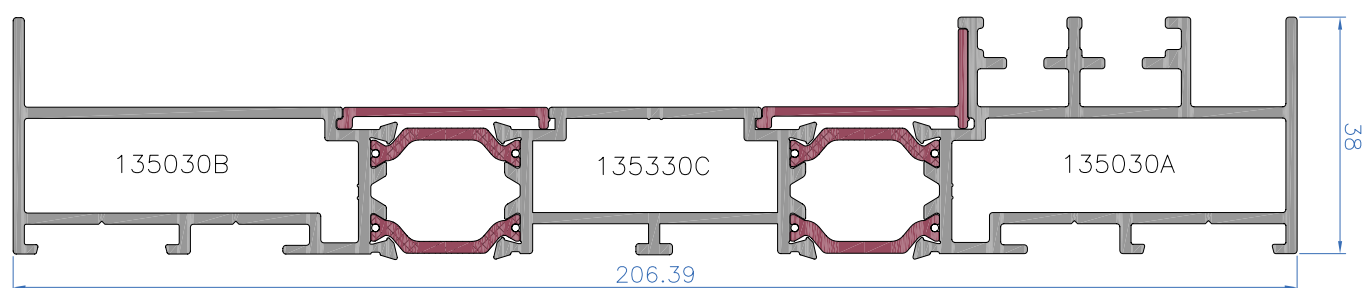

Ref: 135400

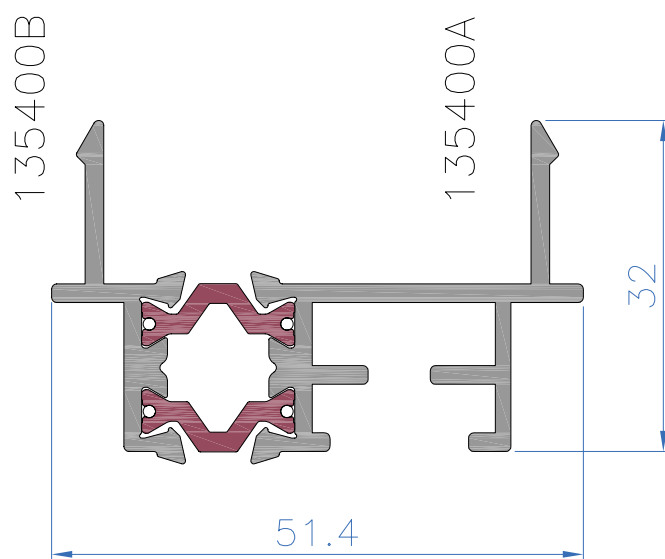



**HIERROS
JÁTIVA**

SM-135RT

CORREDERA ELEVABLE CON ROTURA

LIFT AND SLIDE WITH BREAK

PERFILES | PROFILES

Ref: 135401

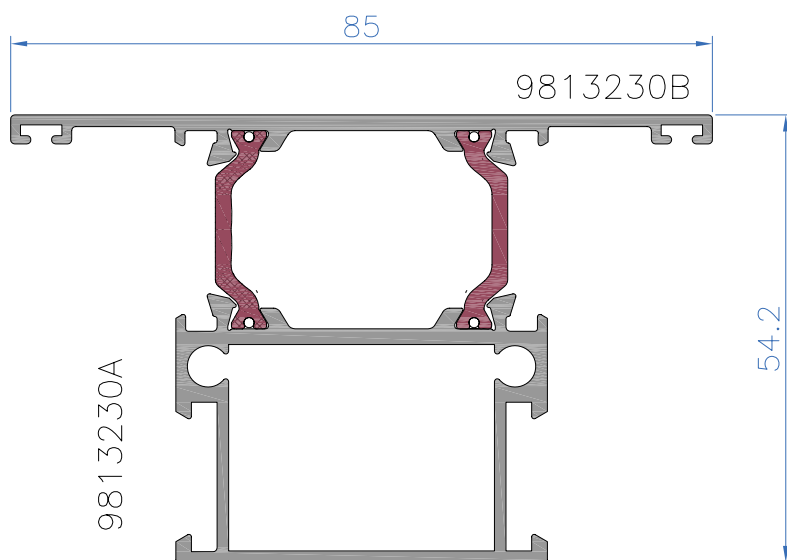





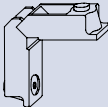
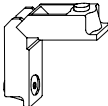
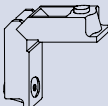
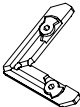
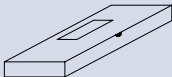
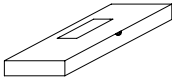
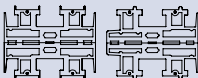
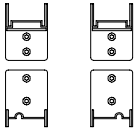
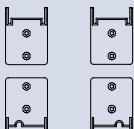
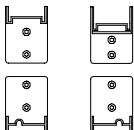

ACCESORIOS | ACCESSORIES

Código Code	Figura Drawing	Descripción Description
1350102		ESCUADRA MARCO PERIMETRAL SM-135 PERIMETRAL FRAME BRACKET SM-135
1350142		ESCUADRA HOJA PERIMETRAL SM-135 PERIMETRAL SASH BRACKET SM-135
1350162		ESCUADRA PARA FIJO PERIMETRAL 37X16 ELV-135 BRACKET FOR FIXED PERIMETRAL 37X16 ELV-135
1350702		ESCUADRA ALINEAMIENTO HOJA ELEVABLES Y MARCO HOJA OCULTA ALIGN. BRACKETS ELEVABLE SASH AND HIDDEN SASH FRAME
1351030		KIT ELEV. CARROS HS300 KIT ELEV. CART HS300
1351040		KIT CARROS TANDEM 400 KGS. + ACC. CONEXION TANDEM CART KIT 400KG + ACC. CONNECTION
1351203		JUEGO JUNTAS ESTANQUEIDAD MARCOS FRAME SEALING JOINT SET
1351303		JUEGO PRESILLAS ELEVABLE 2 HOJAS (4 PIEZAS) ELEV. PLUGS SET 2 SASH (4 PIECES)
1351313		JUEGO PRESILLAS CORRED. 2 HOJAS (4 PIEZAS) PLUGS SET SLIDING 2 SASH (4 PIECES)
1351323		JUEGO PRESILLAS 1 HOJA Y FIJO (4 PIEZAS) PLUGS SET SASH AND FIXED (4 PIECES)

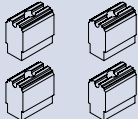
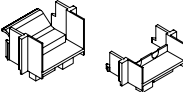
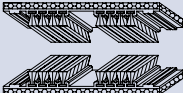
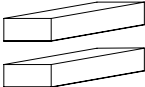

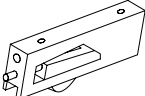
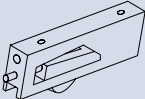
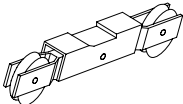
ACCESORIOS | ACCESSORIES

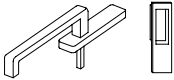
Código Code	Figura Drawing	Descripción Description
1351333		KIT TACOS FIJACION HOJA FIJA KIT BLOCKS FIXING SASH FIXED
1351403		JUEGO TAPAS PERFIL 4 HOJAS PROFILE CAPS SET 4 SASH
1351501		JUEGO CORTAVIENTOS CORREDERA WINDBREAKER SET SLIDING
1351513		JUEGO CORTAVIENTOS ELEVABLE WINDBREAKER ELEVABLE SET
1351653		TOPE DOBLE HOJA DOBLE SASH LOCK
1351712		RUEDA REGULABLE DE 1 RODAMIENTO ADJUSTABLE WHEEL 1 BEARING
1351815		TANDEM FIJO INOX STAINLESS FIXED TANDEM
1351825		RUEDA FIJA INOX STAINLESS FIXED WHEEL
1353113		DEFLECTOR AIRE DESCARGA LATERAL AIR DEFLECTOR LATERAL DISCHARGE
1354212		KIT MANILLA INTERIOR ELEVABLE CON TORNILLOS M5X70 ELEV. INT. HANDLE KIT WITH SCREWS M5X70



ACCESORIOS | ACCESSORIES

Código Code	Figura Drawing	Descripción Description
1354222		KIT MANILLA DOBLE ELEVABLE CON BOCALLAVE M5x70 ELEV. DOBLE HANDLE KIT WITH KEYHOLE M5x70
1354242		KIT MANILLA INTERIOR ELEVABLE CON BOCALLAVE M5x70 ELEV. INT. HANDLE KIT WITH KEYHOLE M5x70
1354312		MANILLA NEW YORK, MANGO CORTO, TORNILLOS INCLUIDOS NEW YORK HANDLE, SHORT HANDGRIP, SCREWS INCLUDED
1354322		MANILLA NEW YORK, MANGO LARGO, TORNILLOS INCLUIDOS NEW YORK HANDLE, LONG HANDGRIP, SCREWS INCLUDED
1356011		CREMONA CORRED.LINEA L-600 HANDLE L-600
1356021		CREMONA CORRED.LINEA L-1000 HANDLE L-1000
1356041		CREMONA CORRED.LINEA L-1800 HANDLE L-1800
1356114		PLETINA CONEXIÓN GR.150 (720-1500 MM.) CONNECTION PLATEN
1356124		PLETINA CONEXIÓN GR.200 (1501-2000 MM.) CONNECTION PLATEN
1356134		PLETINA CONEXIÓN GR.250 (2001-2500 MM.) CONNECTION PLATEN







**HIERROS
JÁTIVA**

SM-135RT

CORREDERA ELEVABLE CON ROTURA

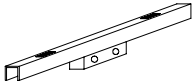
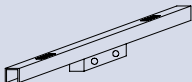
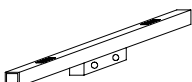
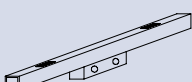

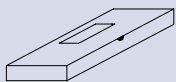
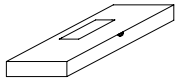



LIFT AND SLIDE WITH BREAK

ACCESORIOS | ACCESSORIES

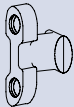
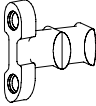
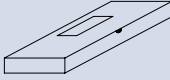
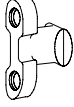
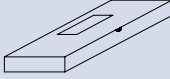
Código Code	Figura Drawing	Descripción Description
1356144		PLETINA CONEXIÓN GR.323 (2501-3235 MM.) CONNECTION PLATEN
1356211		CREMONA ELEVABLE HS300 GR.180 (1200-1800 MM.) ELEV. HANDLE
1356221		CREMONA ELEVABLE HS300 GR.210 (1801-2100 MM.) ELEV. HANDLE
1356231		CREMONA ELEVABLE HS300 GR.240 (2101-2400 MM.) ELEV. HANDLE
1356241		CREMONA ELEVABLE HS300 GR.270 (2401-2700 MM.) ELEV. HANDLE
1356251		SUPLEMENTO ALTURA HASTA 3300 MM. HEIGHT SUPPLEMENT UNTIL 3300MM.
1356322		KIT CALZOS CREMONA ELEVABLE HS-300 ELEV. HANDLE PLUGS KIT HS-300
1356330		BOLSA ACCESORIOS ELEVABLE HS-300 ACCESSORIES BAG ELEVABLE HS-300
1356502		CREMONA CORRED.LINEA L-600 MULTIPOINT HANDLE L-600
1356512		CREMONA CORRED.LINEA L-600 SERIE C-75RT /C-70 MULTIPOINT HANDLE L-600

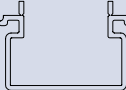

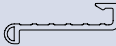





ACCESORIOS | ACCESSORIES

Código Code	Figura Drawing	Descripción Description
1356522		CERRADERO ELEVABLE DE 8,5 MM. LOCKING ELEVABLE 8,5MM
1356542		CERRADERO VENTILACION ELEVABLE DE 8,5 MM. VENTILATION LOCK ELEVABLE 8,5MM
1356552		KIT CIERRE ESQUEMA C ELEVABLE LOCKING KIT C SCHEME ELEVABLE
1356562		CERRADERO ELEVABLE CORTE A INGLETE SM-135 LOCKING ELEVABLE MITER
1357013		PIEZA GUIA SUPERIOR HOJA ELEVABLE SM-135 SUP. GUIDE ELEVABLE SASH PIECE
1028013		PERFIL BAÑERA PVC PARA MARCO SERIES SM-100 Y SM-35 PVC TUB PROFILE FOR FRAME
1358013		PERFIL BAÑERA TUB PROFILE
1358033		PERFIL COMPLEMENTO MARCO LATERAL COMPLEMENT PROFILE LATERAL FRAME
1358043		PERFIL COMPLEMENTO HOJA CENTRAL COMPLEMENT PROFILE CENTRAL SASH
1358053		PERFIL COMPLEM. MARCO LATERAL S/PESTAÑA LATERAL FRAME COMPLEMENT PROFILE WITHOUT FLANGE



ACCESORIOS | ACCESSORIES

Código Code	Figura Drawing	Descripción Description
0708153		CREMONA CORRED.LINEA L-600 SERIE C-75RT /C-70 MULTIPOINT HANDLE L-600
1008163		CARRIL DE RODADURA ELEV-100 Y SM135 RUNNING RAIL ELEV-100 AND SM135
0858206		JUNTA ACRISTALAMIENTO EXTERIOR DE 5 MM. 5 MM EXT. GLAZING JOINT
1028206		JUNTA ACRISTALAMIENTO EXT. ALETA DE 3 MM. 3 MM FIN EXT. GLAZING JOINT
1358216		JUNTA HOJA ELEVABLE ELEVABLE SASH JOINT
1028013		PERFIL BAÑERA PVC PARA MARCO SERIES SM-100 Y SM-35 PVC TUB PROFILE FOR FRAME
1358226		HOJA SUP.ELV GUIDE RUBBER



HUECO PARA CRISTAL | SPACE FOR CRYSTAL

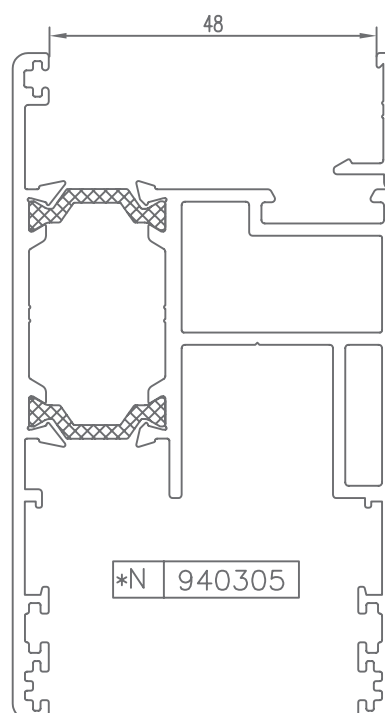
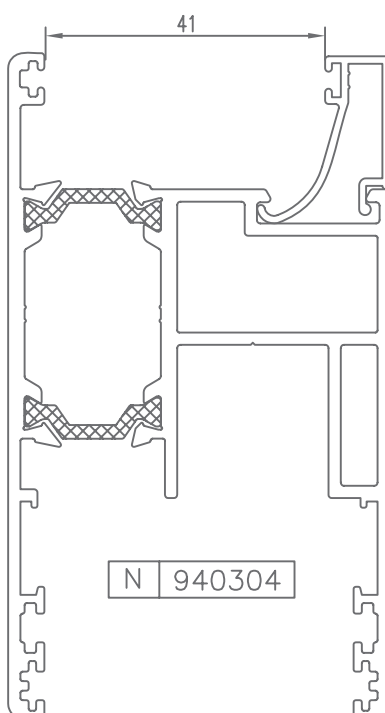
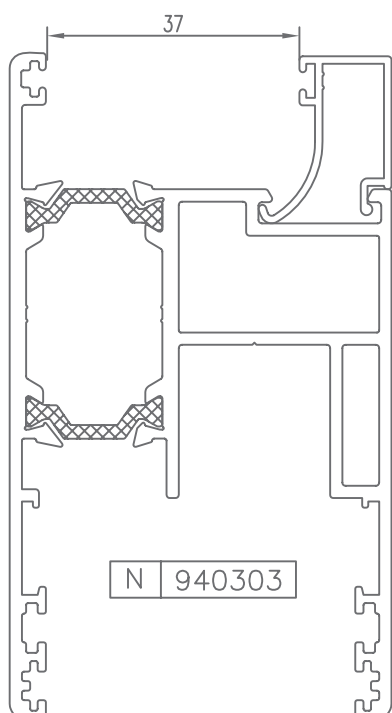
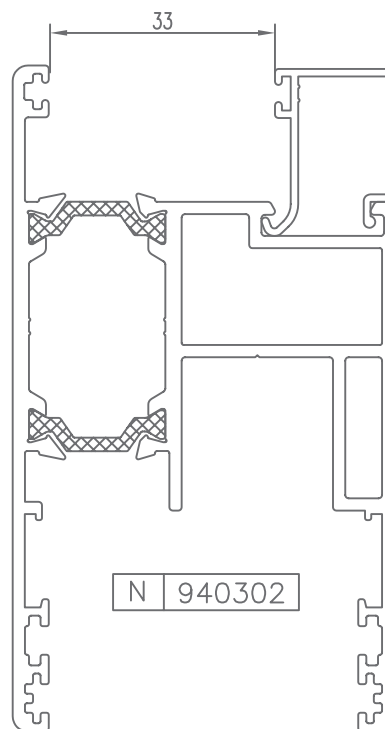
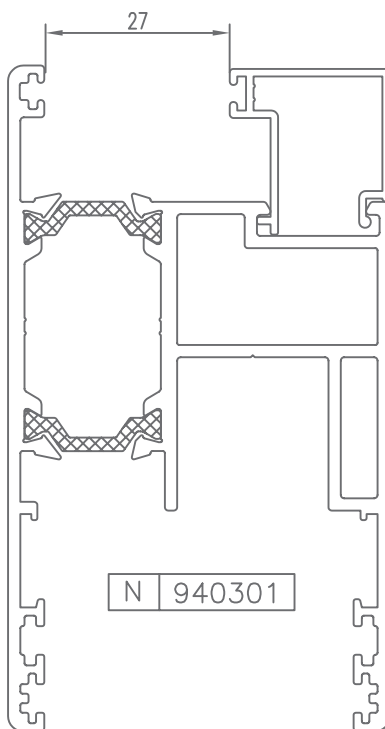
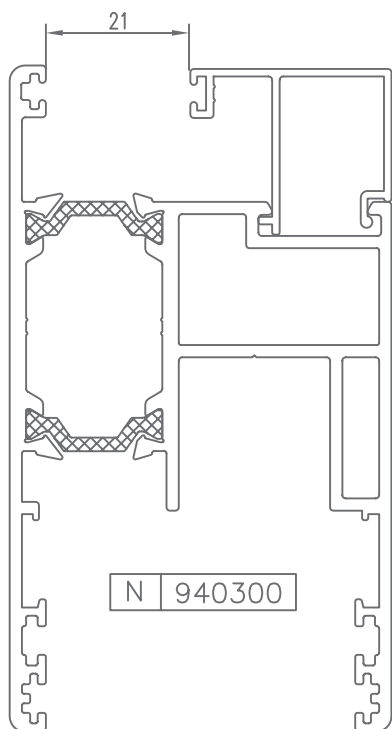

* CONSULTAR



HUECO PARA CRISTAL | SPACE FOR CRYSTAL

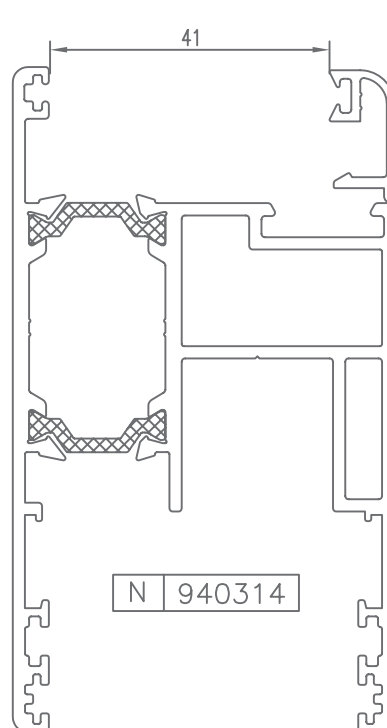
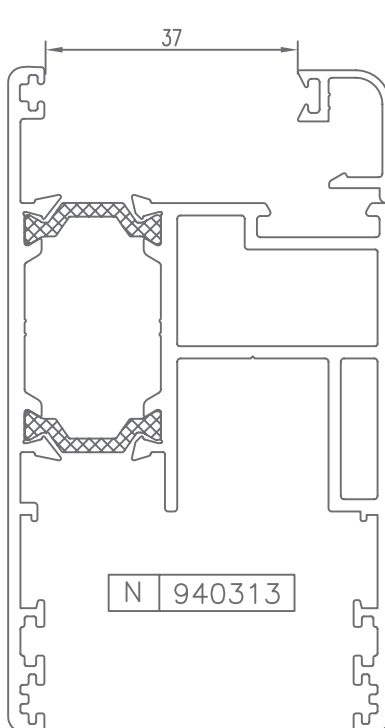
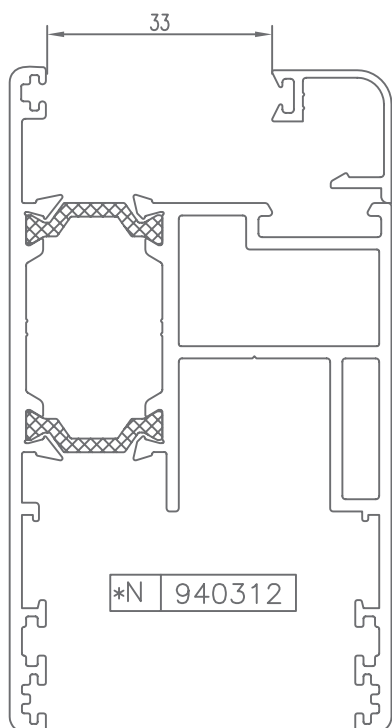
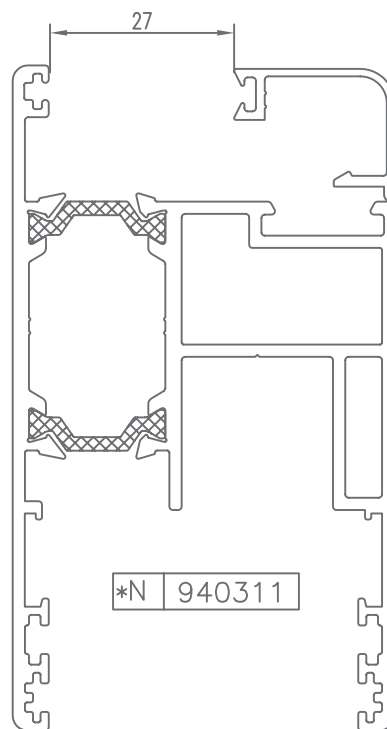
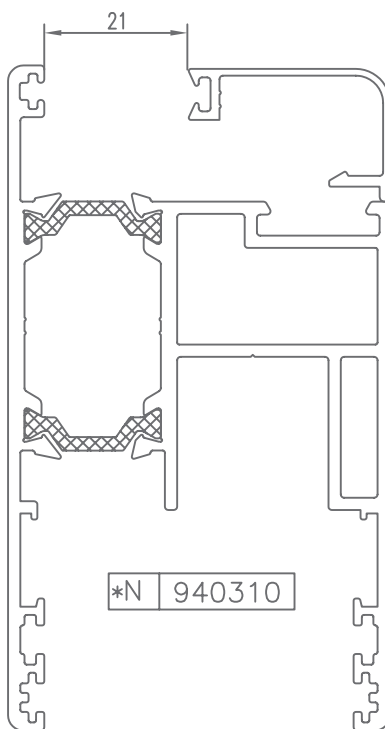
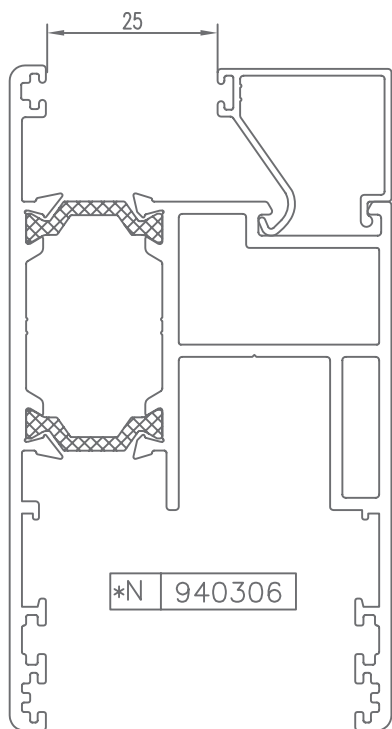

* CONSULTAR





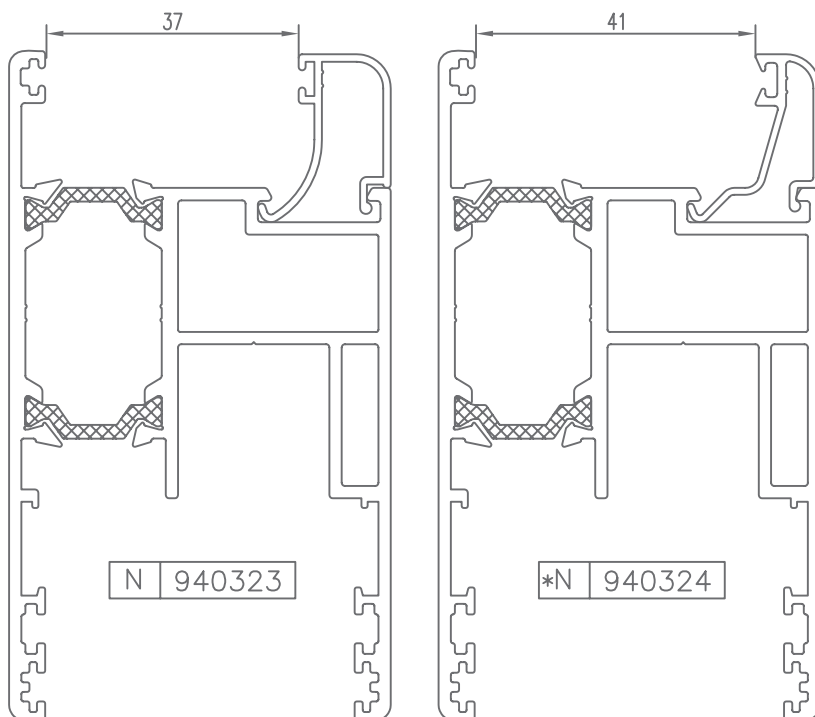
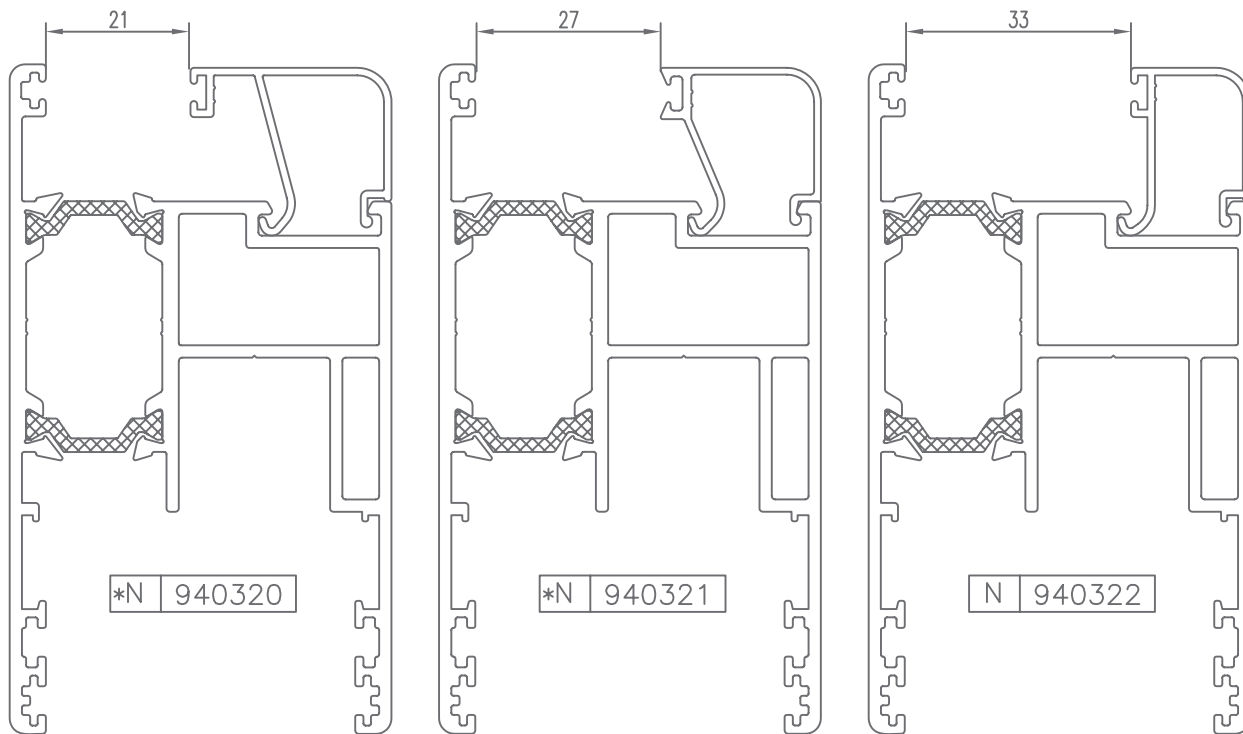





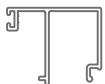

HUECO PARA CRISTAL | SPACE FOR CRYSTAL



* CONSULTAR



HUECO PARA CRISTAL | SPACE FOR CRYSTAL

CÓDIGO	SECCIÓN	DESCRIPCIÓN	HUECO
940300		Junquillo cabeza 29,5 mm.	21 mm.
940301		Junquillo cabeza 23,5 mm.	27 mm.
940302		Junquillo cabeza 17,5 mm.	33 mm.
940303		Junquillo cabeza 13,5 mm.	37 mm.
940304		Junquillo cabeza 9,5 mm.	41 mm.
*940305		Junquillo grapa cabeza 2,6 mm.	48 mm.
*940306		Junquillo cabeza 25,5 mm.	25 mm.
*940310		Junquillo curvo grapa cabeza 29,5 mm.	21 mm.
*940311		Junquillo curvo grapa cabeza 23,5 mm.	27 mm.
940312		Junquillo curvo grapa cabeza 17,5 mm.	33 mm.
940313		Junquillo curvo grapa cabeza 13,5 mm.	37 mm.

* CONSULTAR



HUECO PARA CRISTAL | SPACE FOR CRYSTAL

CÓDIGO	SECCIÓN	DESCRIPCIÓN	HUECO
*940314		Junquillo curvo grapa cabeza 9,5 mm.	41 mm.
*940320		Junquillo curvo cabeza 29,5 mm.	21 mm.
*940321		Junquillo curvo cabeza 23,5 mm.	27 mm.
940322		Junquillo curvo cabeza 17,5 mm.	33 mm.
940323		Junquillo curvo cabeza 13,5 mm.	37 mm.
*940324		Junquillo curvo cabeza 9,5 mm.	41 mm.
*980301		Junquillo cabeza 38,3 mm.	12 mm.
*980302		Junquillo cabeza 35,5 mm.	15 mm.

* CONSULTAR



**HIERROS
JÁTIVA**

CENTRAL

Pol.Ind. "La Vila" Parcela 5.
46819 / Novetlé / Valencia (Spain)
administracion@hierrosjativa.com

Tel.: 96 227 08 00
Fax.: 96 227 41 63
HIERRO: 678 255 770
ALUMINIO: 678 252 153

.....

DELEGACIÓN ALICANTE

Pol.Ind. I-8, Calle Catral
033330 / Crevillente / Alicante (Spain)
crevillente@hierrosjativa.com

Tel.: 96 540 45 61
Fax.: 96 540 46 45

.....

DELEGACIÓN ZARAGOZA

Alfredo Abad

alfredoberdusan@gmail.com
Tel.: 647 576 092