



CORREDERA ELEVABLE
ELEVABLE SLIDING

Serie 100

PERFILES | ACCESORIOS





**HIERROS
JATIVA**

**CORREDERA ELEVABLE
ELEVABLE SLIDING**

SERIE 100

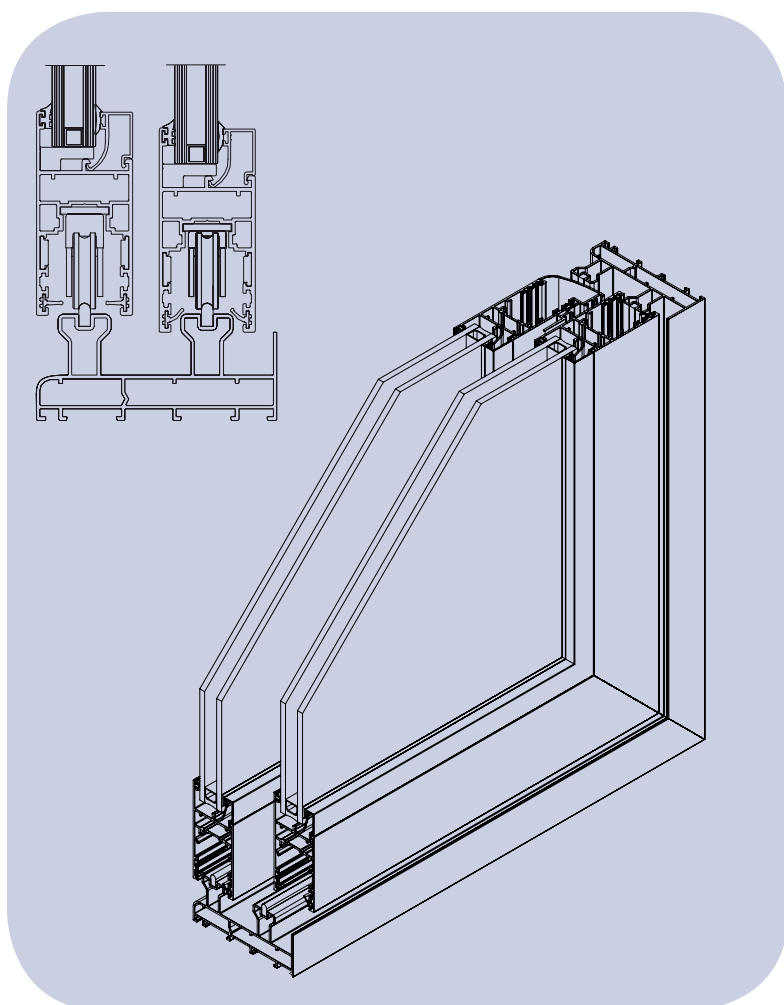

Características técnicas



SECCIÓN MARCO	SECCIÓN HOJA	ALT. GALCE VIDRIO	HUECO VIDRIO MÁX.	ESPESOR NOMINAL
100	40	20	33	1,5

Homologación

AIRE	AGUA	VIENTO	TÉRMICA	ACÚSTICA RW
3	7A	C5	4,17 W/m ² K	33 dB

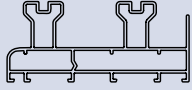
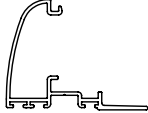
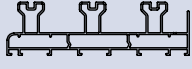

PERFILES | PROFILES

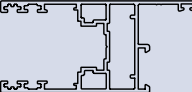
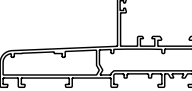
Referencia Reference	Esquema Scheme	Descripción Description
10001		MARCO PERIMETRAL DE 2 CARRILES PERIMETRAL FRAME 2 WAYS
10004		SUPLEMENTO CENTRAL CURVO CURVED CENTRAL COMPLEMENT
10030		MARCO PERIMETRAL DE TRES CARRILES PERIMETRAL FRAME 3 WAYS
10041		PERFIL DE CUATRO HOJAS 4 SASH PROFILE
10060		HOJA PERIMETRAL PERIMETRAL SASH
10080		FIJO PERIMETRAL PERIMETRAL FIXED



PERFILES | PROFILES

Ref: 10001

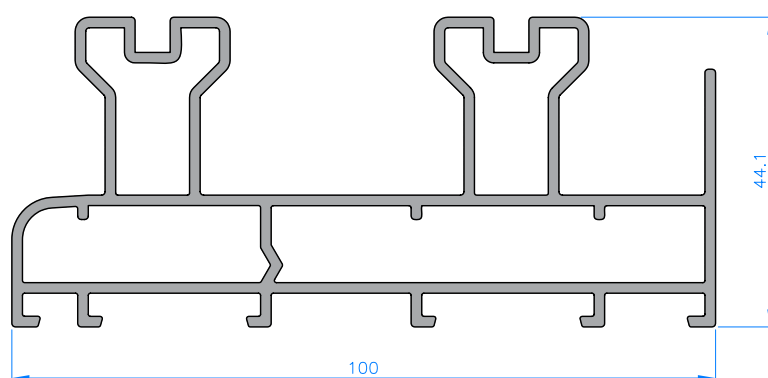

Ref: 10004

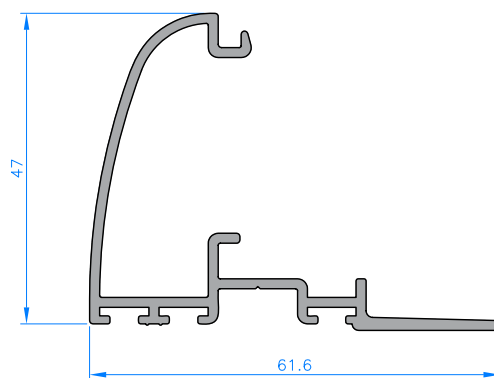

Ref: 10030

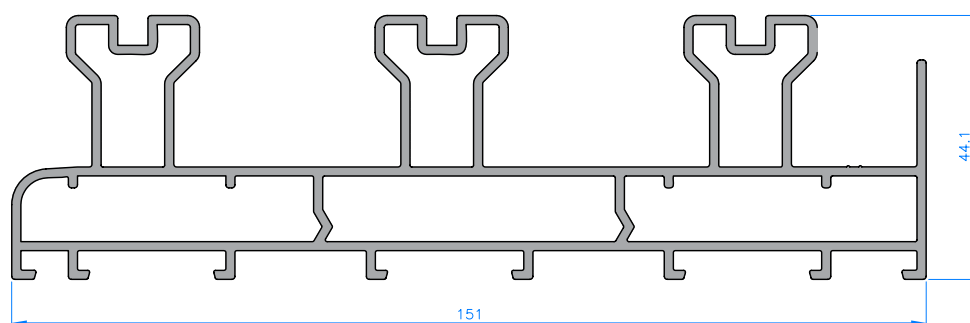



PERFILES | PROFILES

Ref: 10041

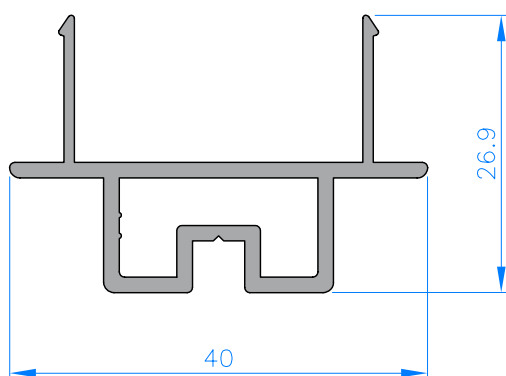

Ref: 10060

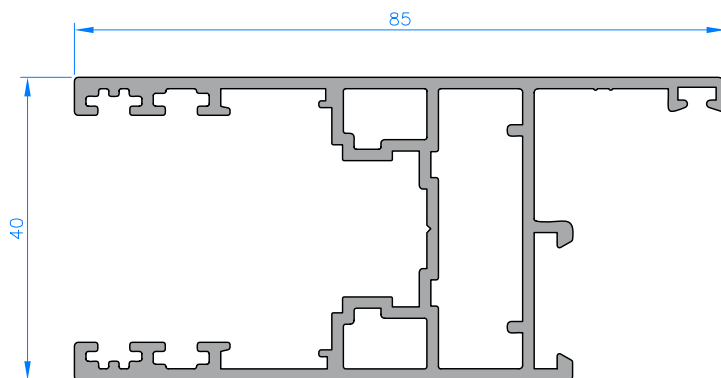

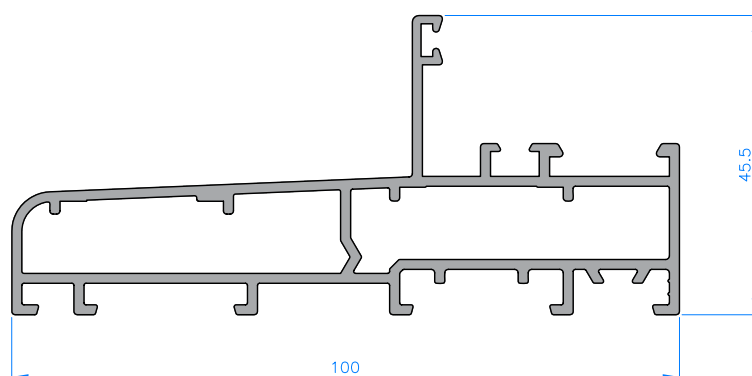

Ref: 10080





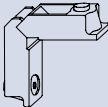
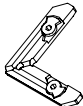
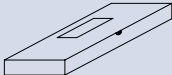
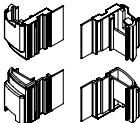
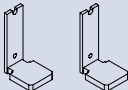
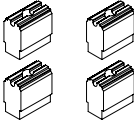
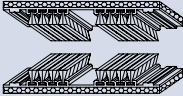
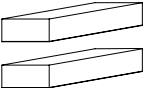

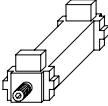
ACCESORIOS | ACCESSORIES

Código Code	Figura Drawing	Descripción Description
0500112		ESCUADRA MARCO C60 MURO-H. PROYECT.TAP. HOJA C70 Y ELV-100 SLIDING BRACKETS FRAME AND SASH PROJECTING WALL
1350702		ESCUADRA ALINEAMIENTO HOJA ELEVABLES Y MARCO HOJA OCULTA ALIGN. BRACKETS ELEVABLE SASH AND HIDDEN SASH FRAME
1001030		KIT CARROS ELEVABLE HS200 PARA ELV-100 KIT ELEV. CART HS200
1001303		JUEGO PRESILLAS (4 PIEZAS) PLUGS SET 8 (4 PIECES)
1001323		KIT TOPE LATERAL KIT LATERAL TOP
1001333		KIT TACOS FIJACION HOJA F KIT BLOCKS FIXING SASH F
1001501		JUEGO CORTAVIENTOS CORREDERA WINDBREAKER SET SLIDING
1001513		JUEGO CORTAVIENTOS ELEVABLE WINDBREAKER ELEVABLE SET
1351653		TOPE DOBLE HOJA DOBLE SASH LOCK
1001712		RUEDA REGULABLE DE 2 RODAMIENTOS ADJUSTABLE WHEEL 2 BEARINGS



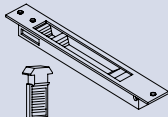
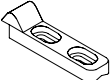
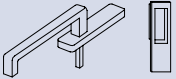
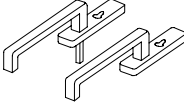
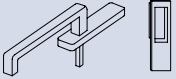
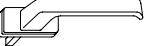
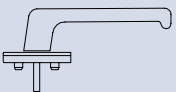
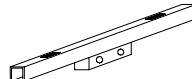

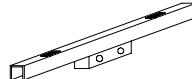
ACCESORIOS | ACCESSORIES

Código Code	Figura Drawing	Descripción Description
1001911		CIERRE CON GANCHO LOOKING HOOK
1001932		CERRADERO LOCKING
1354212		KIT MANILLA DOBLE ELEVABLE CON BOCALLAVE M5x70 ELEV. INT. HANDLE KIT WITH SCREWS M5x70
1354222		KIT MANILLA DOBLE ELEVABLE CON BOCALLAVE M5x70 ELEV. DOBLE HANDLE KIT WITH KEYHOLE M5x70
1354242		KIT MANILLA INTERIOR ELEVABLE CON BOCALLAVE M5x70 ELEV. INT. HANDLE KIT WITH KEYHOLE M5x70
1354312		MANILLA NEW YORK, MANGO CORTO, TORNILLOS INCLUIDOS NEW YORK HANDLE, SHORT HANDGRIP, SCREWS INCLUDED
0756041		MANILLA NEW YORK, MANGO LARGO, TORNILLOS INCLUIDOS NEW YORK HANDLE, LONG HANDGRIP, SCREWS INCLUDED
1356011		CREMONA CORRED. LINEA L-600 HANDLE L-600
1356021		CREMONA CORRED. LINEA L-1000 HANDLE L-1000
1356041		CREMONA CORRED. LINEA L-1800 HANDLE L-1800

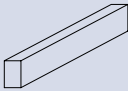
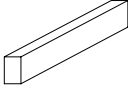
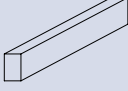
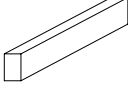
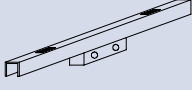
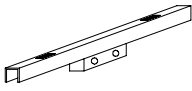
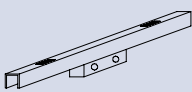
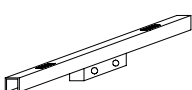

ACCESORIOS | ACCESSORIES

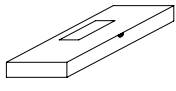
Código Code	Figura Drawing	Descripción Description
1356114		PLETINA CONEXIÓN GR.150 (720-1500 MM.) CONNECTION PLATEN
1356124		PLETINA CONEXIÓN GR.200 (1501-2000 MM.) CONNECTION PLATEN
1356134		PLETINA CONEXIÓN GR.250 (2001-2500 MM.) CONNECTION PLATEN
1356144		PLETINA CONEXIÓN GR.323 (2501-3235MM.) CONNECTION PLATEN
1006211		CREMONA ELEVABLE HS200 GR.180 (1200-1800 MM.) ELEV. HANDLE
1006221		CREMONA ELEVABLE HS200 GR.210 (1800-2100 MM.) ELEV. HANDLE
1006231		CREMONA ELEVABLE HS200 GR.240 (2100-2400MM.) ELEV. HANDLE
1006241		CREMONA ELEVABLE HS200 GR.270 (2400-2700 MM.) ELEV. HANDLE
1356251		SUPLEMENTO ALTURA HASTA 3300 MM. HEIGHT SUPPLEMENT UNTIL 3300MM.
1006322		CALZO CARRO ELEVABLE HS200 ELEVABLE CART PLUG HS200







ACCESORIOS | ACCESSORIES

Código Code	Figura Drawing	Descripción Description
1006330		BOLSA ACCESORIOS HS200 ACCESSORIES BAG HS200
1356502		CREMONA CORRED.LINEA L-600 MULTIPOINT HANDLE L-600
1356512		CREMONA CORRED.LINEA L-600 MULTIPOINT HANDLE L-600
1006522		CERRADERO ELEVABLE HS200 DE 11 MM. PARA ELV.100 LOCKING ELEVABLE HS200 11MM
1006542		CERRADERO VENTILACION ELEVABLE HS200 DE 11 MM. PARA ELV-100 LOCKING ELEVABLE VENTILATION HS200 11MM
1006553		CALZO HOJA PARA CORREDERA LINEA SERIE ELV-100 SASH PLUG FOR LINE SLIDING
1006563		CALZO MARCO PARA CORREDERA LINEA SERIE ELV-100 FRAME PLUG FOR LINE SLIDING
0708153		UNIÓN MARCO EN POLIAMIDA UNION FRAME
1008163		CARRIL DE RODADURA ELEV-100 Y SM135 RUNNING RAIL ELEV-100 AND SM135
1008183		JUNTA TAPA CARRILES LAT. Y SUP. PARA ELV-100 LAT. AND SUP WAYS CAP JOINT



ACCESORIOS | ACCESSORIES

Código Code	Figura Drawing	Descripción Description
0858206		JUNTA ACRISTALAMIENTO EXTERIOR DE 5 MM. 5 MM EXT. GLAZING JOINT
1028206		JUNTA ACRISTALAMIENTO EXT. ALETA DE 3 MM. 3 MM FIN EXT. GLAZING JOINT
1358216		JUNTA HOJA ELEVABLE ELEVABLE SASH JOINT
1358226		GOMA GUIA FOLCRADA HOJA SUP.ELV GUIDE RUBBER



HUECO PARA CRISTAL | SPACE FOR CRYSTAL

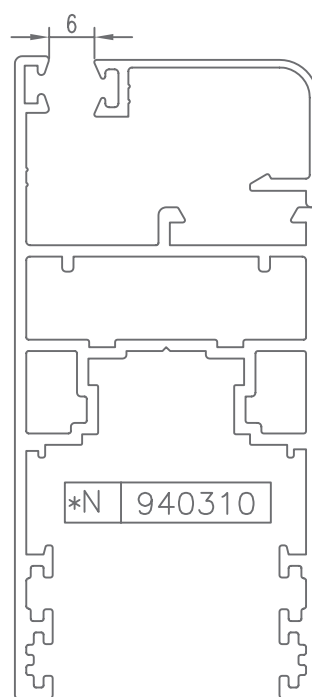
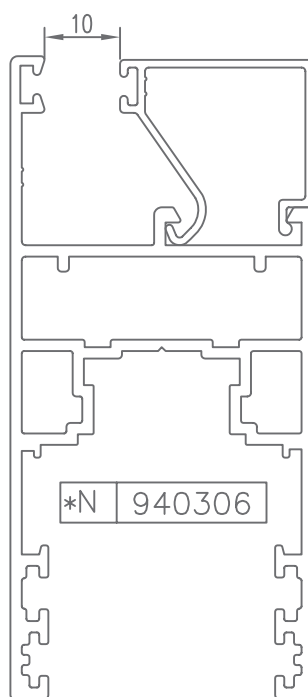
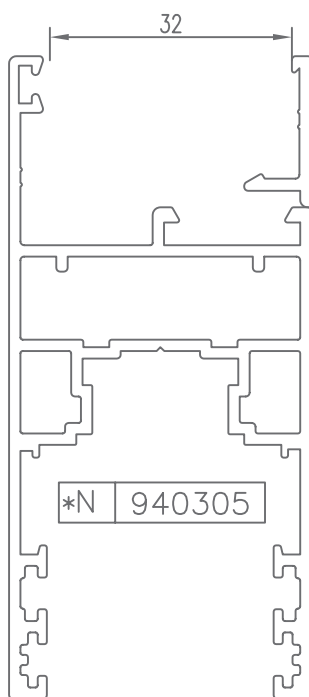
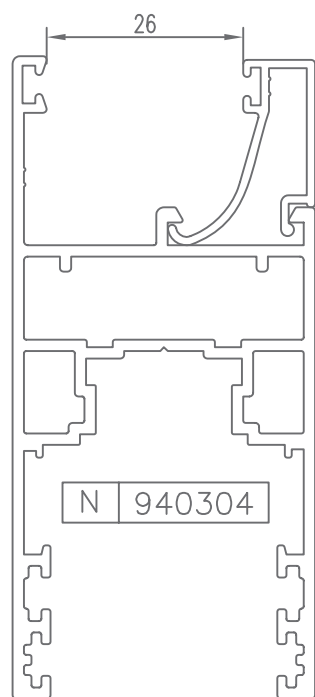
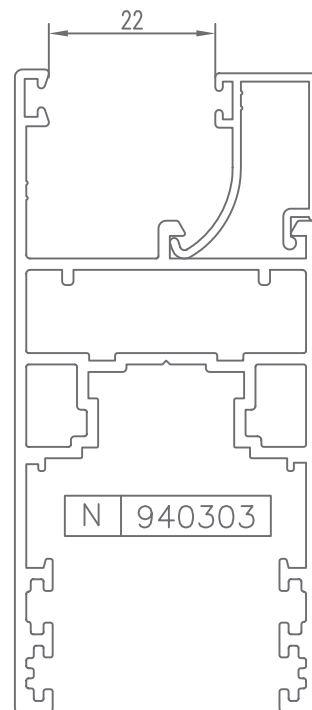
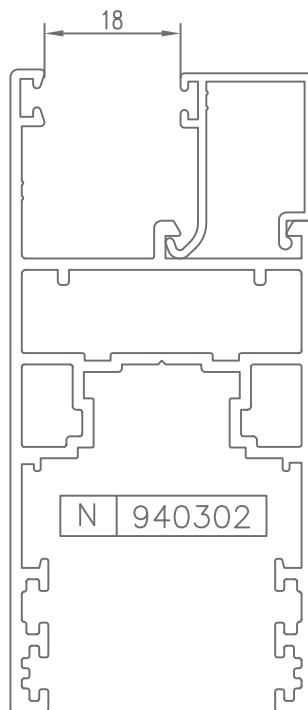
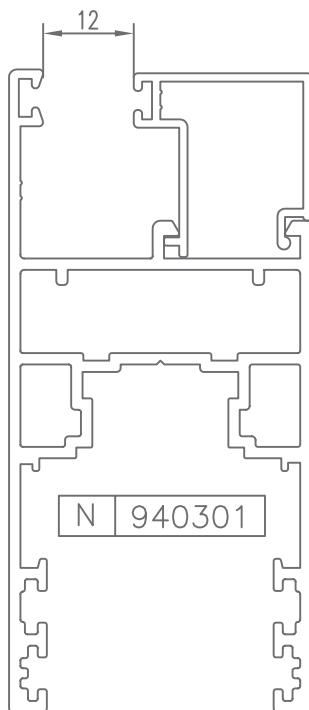
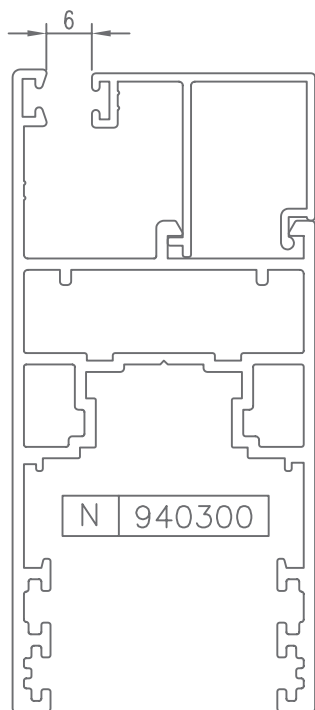

* CONSULTAR



HUECO PARA CRISTAL | SPACE FOR CRYSTAL

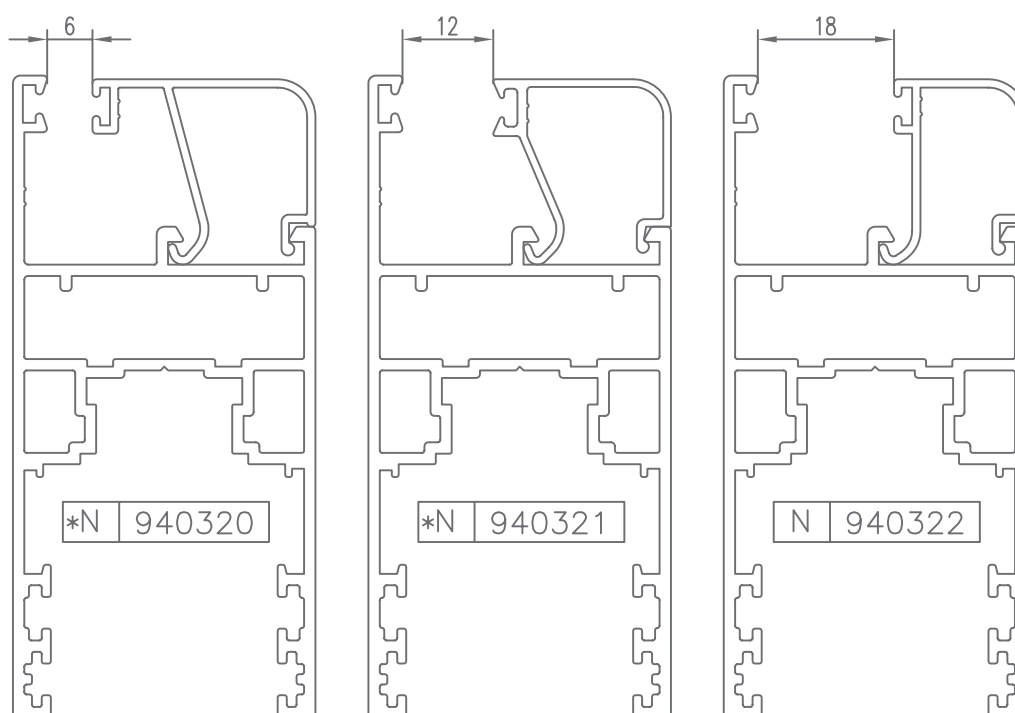
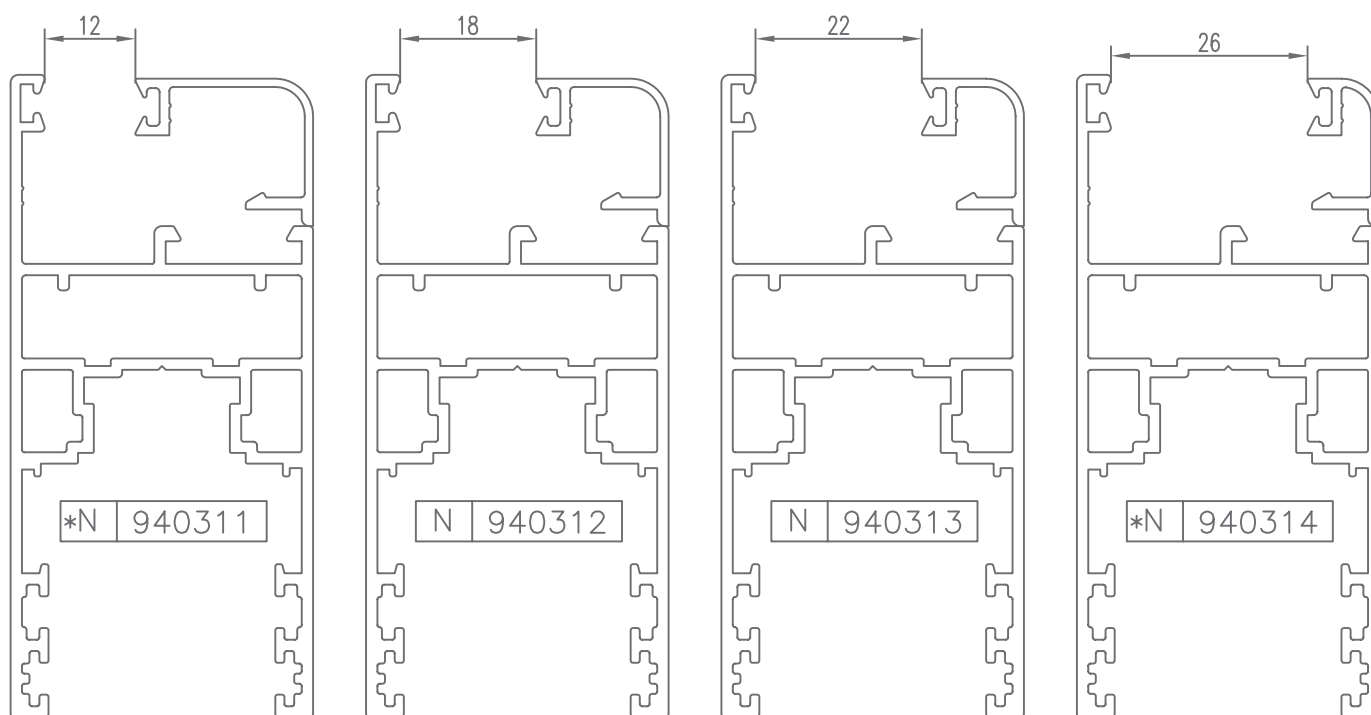

* CONSULTAR



HUECO PARA CRISTAL | SPACE FOR CRYSTAL

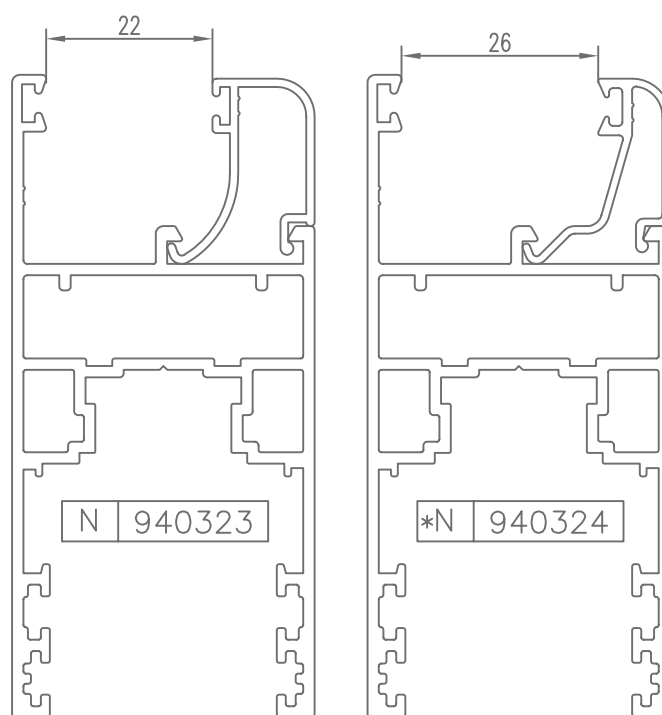

* CONSULTAR



HUECO PARA CRISTAL | SPACE FOR CRYSTAL

CÓDIGO	SECCIÓN	DESCRIPCIÓN	HUECO
940300		Junquillo cabeza 29,5 mm.	6 mm.
940301		Junquillo cabeza 23,5 mm.	12 mm.
940302		Junquillo cabeza 17,5 mm.	18 mm.
940303		Junquillo cabeza 13,5 mm.	22 mm.
940304		Junquillo cabeza 9,5 mm.	26 mm.
*940305		Junquillo grapa cabeza 2,6 mm.	33 mm.
*940306		Junquillo cabeza 25,5 mm.	10 mm.
*940310		Junquillo curvo grapa cabeza 29,5 mm.	6 mm.
*940311		Junquillo curvo grapa cabeza 23,5 mm.	12 mm.
940312		Junquillo curvo grapa cabeza 17,5 mm.	18 mm.
940313		Junquillo curvo grapa cabeza 13,5 mm.	22 mm.

* CONSULTAR



HUECO PARA CRISTAL | SPACE FOR CRYSTAL

CÓDIGO	SECCIÓN	DESCRIPCIÓN	HUECO
*940314		Junquillo curvo grapa cabeza 9,5 mm.	26 mm.
*940320		Junquillo curvo cabeza 29,5 mm.	6 mm.
*940321		Junquillo curvo cabeza 23,5 mm.	12 mm.
940322		Junquillo curvo cabeza 17,5 mm.	18 mm.
940323		Junquillo curvo cabeza 13,5 mm.	22 mm.
*940324		Junquillo curvo cabeza 9,5 mm.	26 mm.
*980301		Junquillo cabeza 38,3 mm.	-- --
*980302		Junquillo cabeza 35,5 mm.	-- --

* CONSULTAR



**HIERROS
JÁTIVA**

CENTRAL

Pol.Ind. "La Vila" Parcela 5.
46819 / Novetlé / Valencia (Spain)
administracion@hierrosjativa.com

Tel.: 96 227 08 00
Fax.: 96 227 41 63
HIERRO: 678 255 770
ALUMINIO: 678 252 153

.....

DELEGACIÓN ALICANTE

Pol.Ind. I-8, Calle Catral
033330 / Crevillente / Alicante (Spain)
crevillente@hierrosjativa.com

Tel.: 96 540 45 61
Fax.: 96 540 46 45

.....

DELEGACIÓN ZARAGOZA

Alfredo Abad

alfredoberdusan@gmail.com
Tel.: 647 576 092