

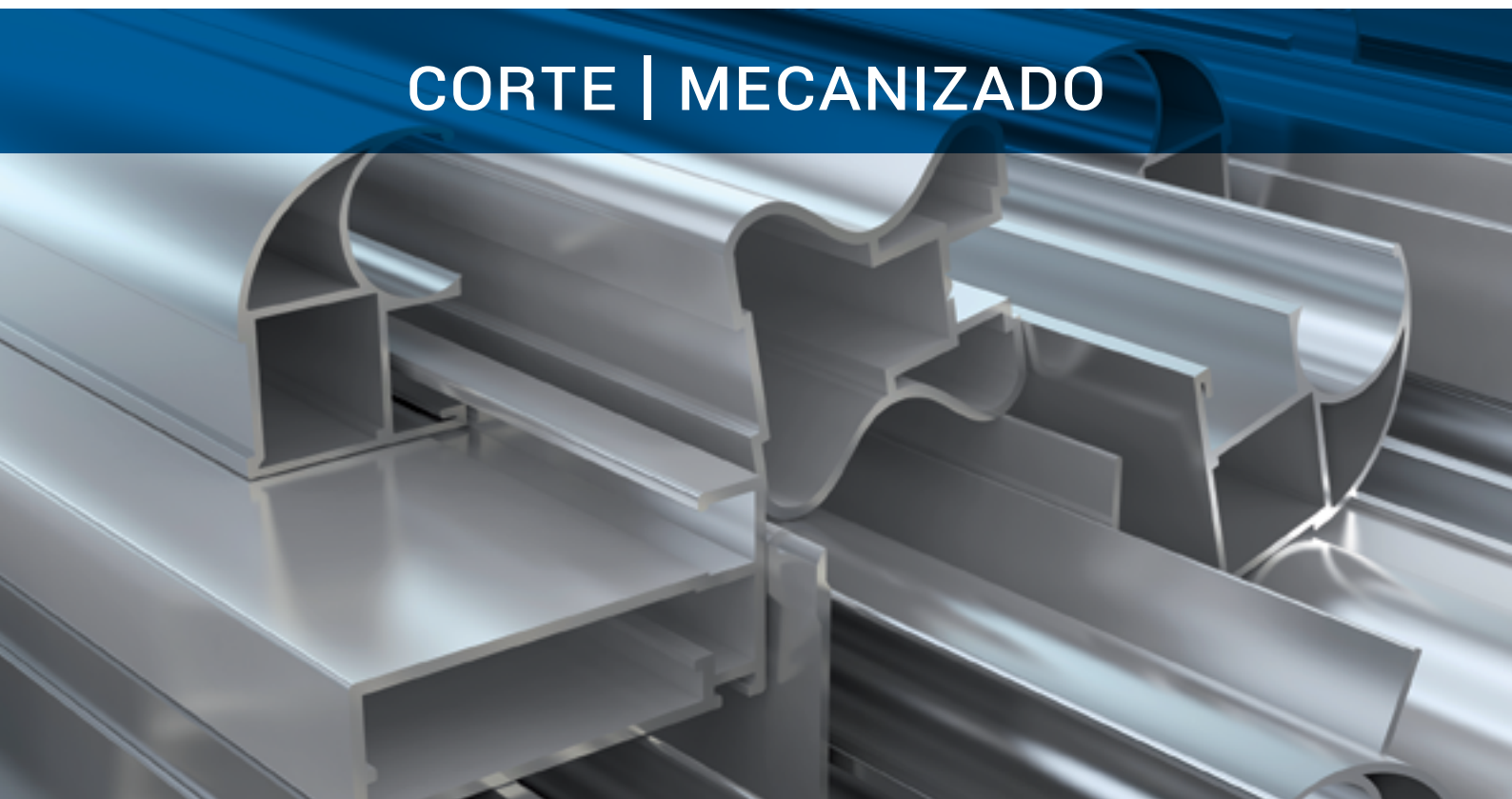

CORREDERA DE CORTE RECTO
STRAIGHT CUT SLIDING

Serie 700

CORTE | MECANIZADO





ESQUEMAS DE CORTE | CUTTING SCHEMES

Corte con fijo independiente
Cutting with fixed independent

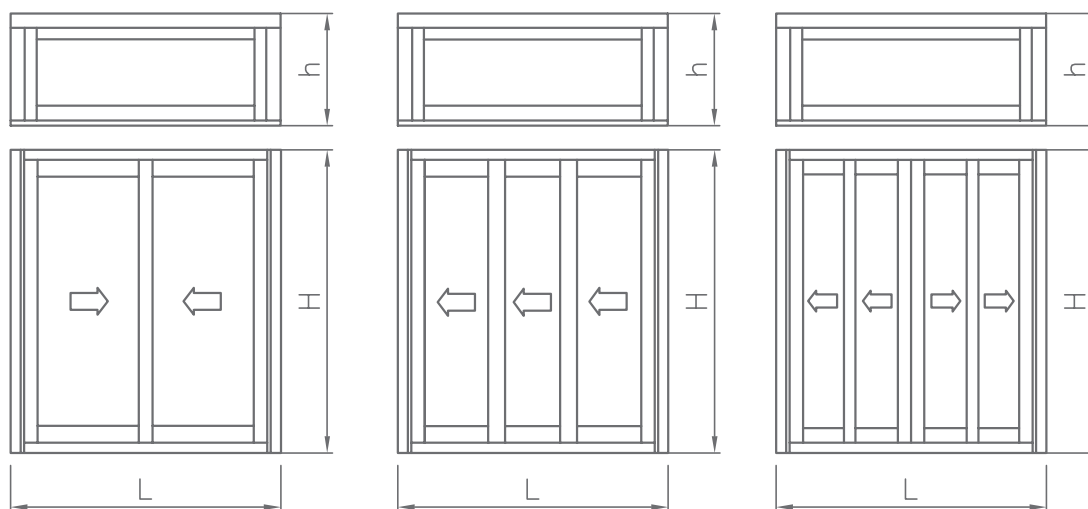

PERFILES – LONGITUDES DE CORTE								
PERFIL	FIGURA	DESCRIPCION	2 HOJAS		3 HOJAS		4 HOJAS	
			CANT.	CORTE	CANT.	CORTE	CANT.	CORTE
700110		MARCO SUPERIOR	1	L-36	1	L-36	1	L-36
700120		MARCO INFERIOR	1	L-36	1	L-36	1	L-36
700130		MARCO LATERAL	2	H	2	H	2	H
700240		HOJA LATERAL CAMARA 12	2	H-60	2	H-60	4	H-60
700045		HOJA LATERAL CAMARA 18	2	H-60	2	H-60	4	H-60
700250		HOJA CENTRAL CAMARA 12	2	H-60	4	H-60	4	H-60
700055		HOJA CENTRAL CAMARA 18	2	H-60	4	H-60	4	H-60
700260		HOJA DE RUEDA CAMARA 12	4	L/2 -13	6	L/3 +8	8	L/4 -4
700065		HOJA DE RUEDA CAMARA 18	4	L/2 -13	6	L/3 +8	8	L/4 -4
700270		ZOCALO CAMARA 12	2	L/2 -13	3	L/3 +8	4	L/4 -4
700075		ZOCALO CAMARA 18	2	L/2 -13	3	L/3 +8	4	L/4 -4
700080		MARCO FIJO SIN CLIP	2	h-27	2	h-27	2	h-27
700090		MARCO FIJO CON CLIP	2	L	2	L	2	L
700400		PERFIL 4 HOJAS					1	H-60
700401		DIVISOR CRISTAL SIMPLE	2	L/2 -13	3	L/3 +8	4	L/4 -4
700402		DIVISOR CRISTAL DOBLE	2	L/2 -13	3	L/3 +8	4	L/4 -4
VARIOS		JUNQUILLO	2	L-48	2	L-48	2	L-48
VARIOS		JUNQUILLO	2	h-70	2	h-70	2	h-70



ESQUEMAS DE CORTE | CUTTING SCHEMES

Corte de dos carriles con fijo clipado

Two ways cutting with fixed clipping

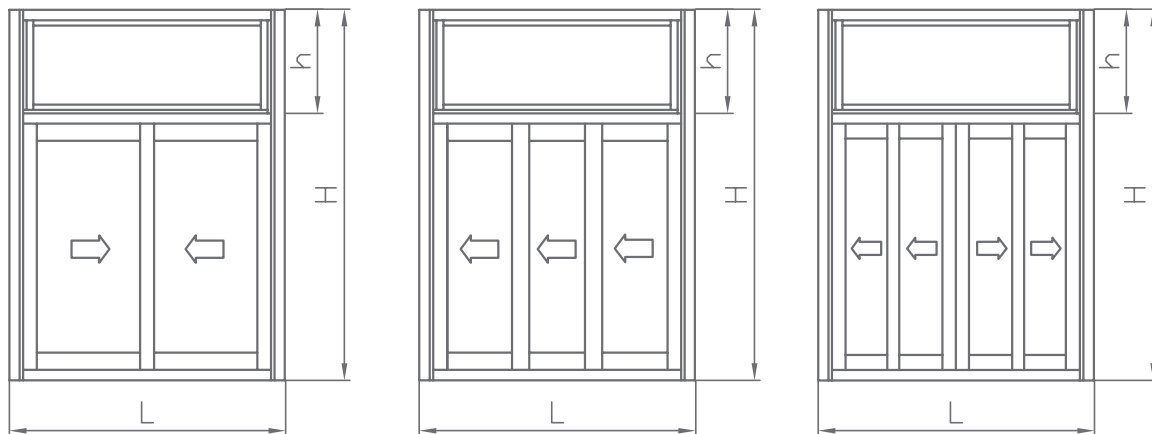

PERFILES – LONGITUDES DE CORTE									
PERFIL	FIGURA	DESCRIPCION	2 HOJAS		3 HOJAS		4 HOJAS		
			CANT.	CORTE	CANT.	CORTE	CANT.	CORTE	
700110		MARCO SUPERIOR	1	L-36	1	L-36	1	L-36	
700120		MARCO INFERIOR	1	L-36	1	L-36	1	L-36	
700130		MARCO LATERAL	2	H	2	H	2	H	
700240		HOJA LATERAL CAMARA 12	2	H -h -60	2	H -h -60	4	H -h -60	
700045		HOJA LATERAL CAMARA 18	2	H -h -60	2	H -h -60	4	H -h -60	
700250		HOJA CENTRAL CAMARA 12	2	H -h -60	4	H -h -60	4	H -h -60	
700055		HOJA CENTRAL CAMARA 18	2	H -h -60	4	H -h -60	4	H -h -60	
700260		HOJA DE RUEDA CAMARA 12	4	L/2 -13	6	L/3 +8	8	L/4 -4	
700270		HOJA DE RUEDA CAMARA 18	4	L/2 -13	6	L/3 +8	8	L/4 -4	
700070		ZOCALO CAMARA 12	2	L/2 -13	3	L/3 +8	4	L/4 -4	
700075		ZOCALO CAMARA 18	2	L/2 -13	3	L/3 +8	4	L/4 -4	
700080		MARCO FIJO SIN CLIP	1	L-35	1	L-35	1	L-35	
700090		MARCO FIJO CON CLIP	1	L-35	1	L-35	1	L-35	
700090		MARCO FIJO CON CLIP	2	h-27	2	h-27	2	h-27	
700400		PERFIL 4 HOJAS					1	H -h -60	
700401		DIVISOR CRISTAL SIMPLE	2	L/2 -13	3	L/3 +8	4	L/4 -4	
700402		DIVISOR CRISTAL DOBLE	2	L/2 -13	3	L/3 +8	4	L/4 -4	
VARIOS		JUNQUILLO	2	L-82	2	L-82	2	L-82	
VARIOS		JUNQUILLO	2	h-76	2	h-76	2	h-76	



ESQUEMAS DE CORTE | CUTTING SCHEMES

Corte de tres carriles 3 hojas

Three ways cutting three sashes

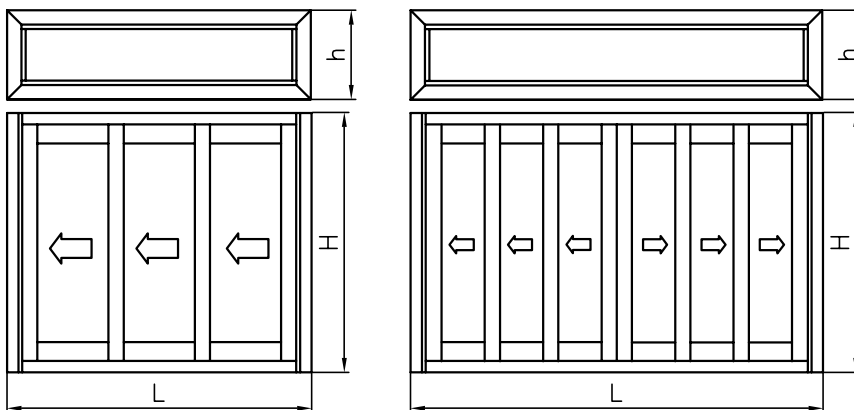

PERFILES – LONGITUDES DE CORTE						
PERFIL	FIGURA	DESCRIPCION	3 HOJAS		6 HOJAS	
			CANT.	CORTE	CANT.	CORTE
700040		HOJA LATERAL CAMARA 12	2	H-60	4	H-60
700045		HOJA LATERAL CAMARA 18	2	H-60	4	H-60
700050		HOJA CENTRAL CAMARA 12	4	H-60	8	H-60
700055		HOJA CENTRAL CAMARA 18	4	H-60	8	H-60
700060		HOJA DE RUEDA CAMARA 12	6	L/3 +8	12	L/6+13
700063		PARTELUCE CAMARA 21	3	L/3 +8	6	L/6+13
700065		HOJA DE RUEDA CAMARA 18	6	L/3 +8	12	L/6+13
700070		ZOCALO CAMARA 12	3	L/3 +8	6	L/6+13
700075		ZOCALO CAMARA 18	3	L/3 +8	6	L/6+13
700140		HOJA LATERAL CAMARA 21	2	H-60	4	H-60
700150		HOJA CENTRAL CAMARA 21	4	H-60	8	H-60
700160		HOJA DE RUEDA CAMARA 21	6	L/3 +8	12	L/6+13
700170		ZOCALO CAMARA 21	3	L/3 +8	6	L/6+13
700310		MARCO SUPERIOR TRES CARRILES	1	L-36	1	L-36
700320		MARCO INFERIOR TRES CARRILES	1	L-36	1	L-36
700330		MARCO LATERAL TRES CARRILES	2	H	2	H
700400		PERFIL 4 HOJAS			1	H -h -60
700401		DIVISOR CRISTAL SIMPLE	3	L/3 +8	6	L/3 +8
700402		DIVISOR CRISTAL DOBLE	3	L/3 +8	6	L/3 +8
10080		MARCO FIJO	2	L	2	L
10080		MARCO FIJO	2	h	2	h
VARIOS		JUNQUILLO	2	L-52	2	L-52
VARIOS		JUNQUILLO	2	h-91	2	h-91



MECANIZADOS | MACHINING

Marco superior

Superior frame

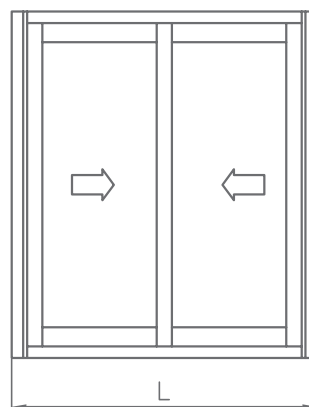
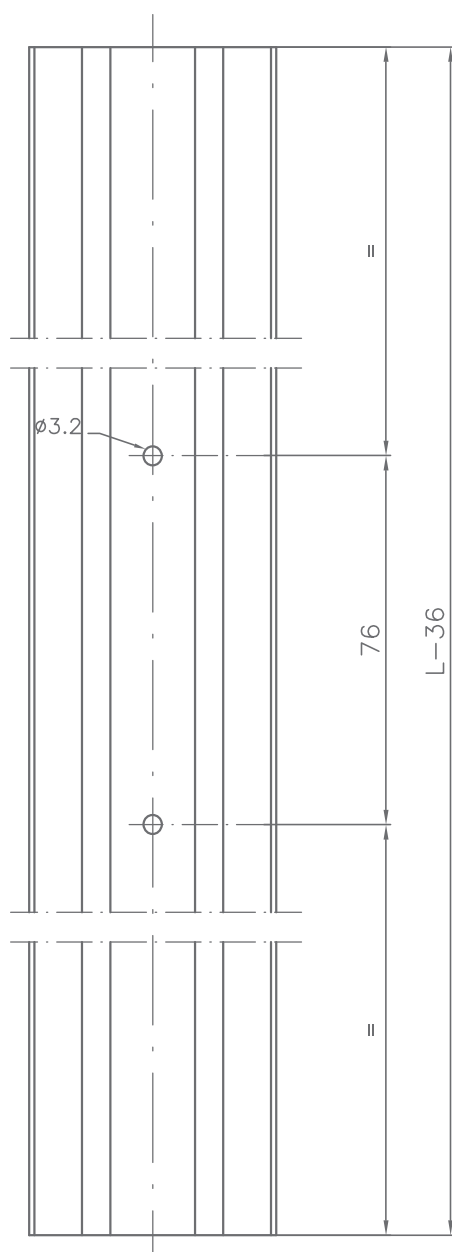
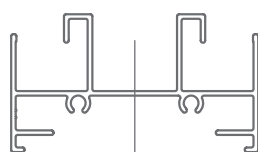



MECANIZADOS | MACHINING

Marco inferior

Inferior frame

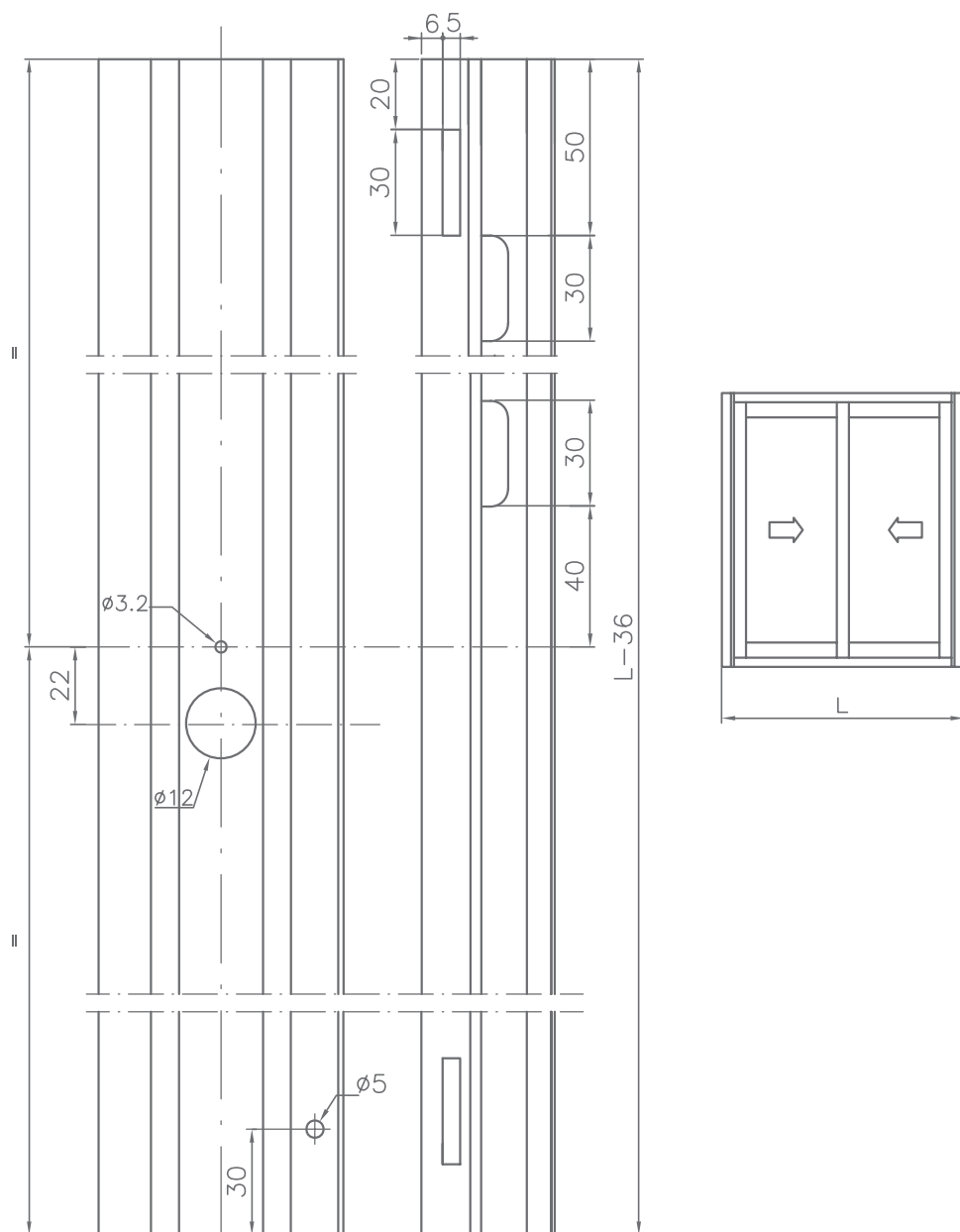
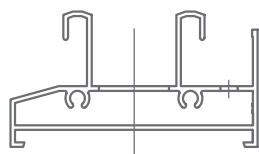



MECANIZADOS | MACHINING

Marco lateral

Lateral frame

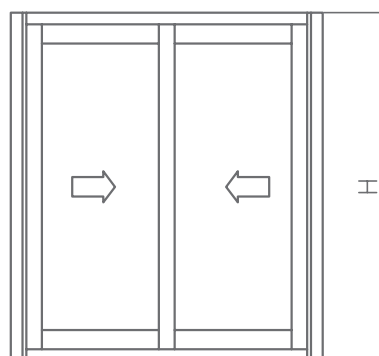
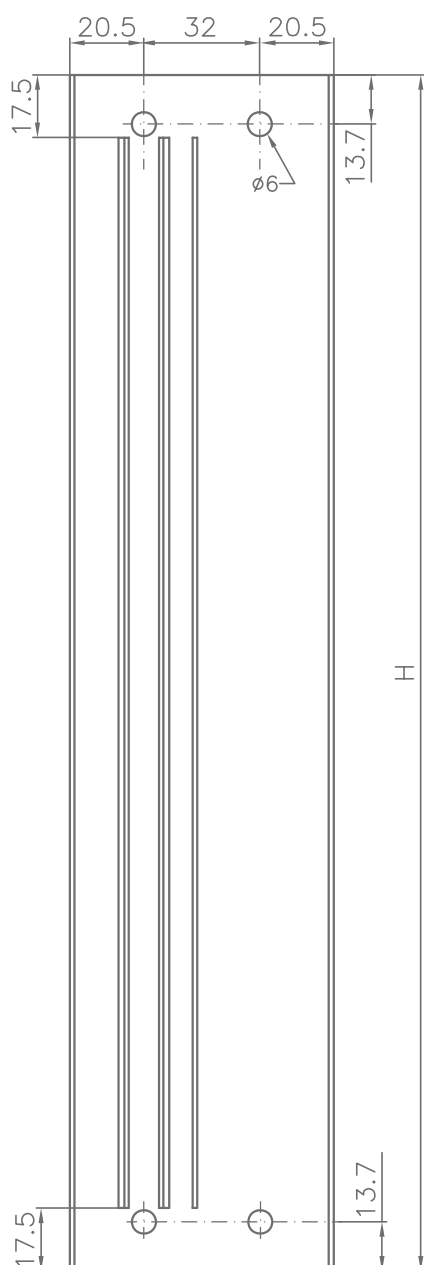



MECANIZADOS | MACHINING

Marco lateral con fijo
Lateral frame with fixed

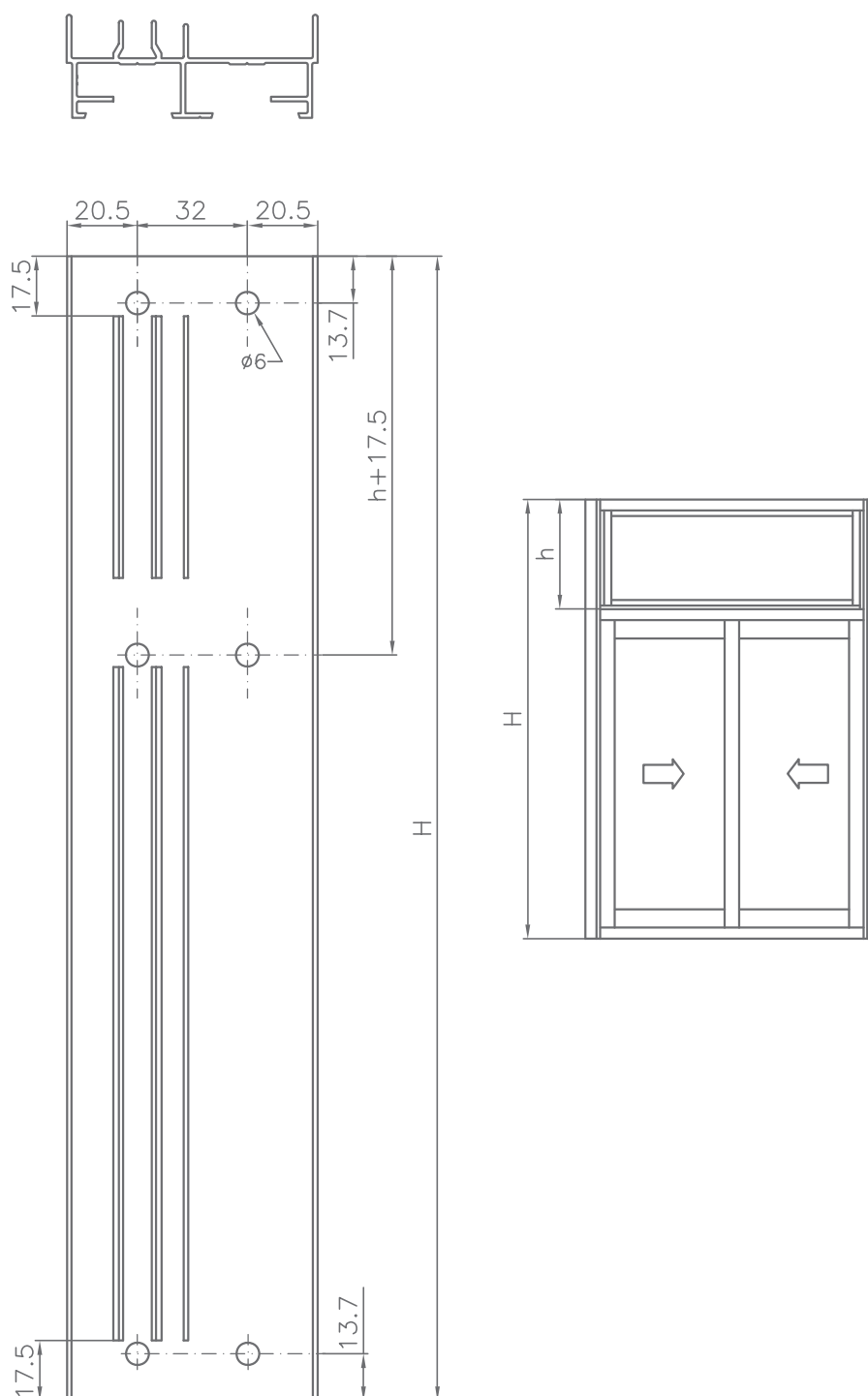



MECANIZADOS | MACHINING

Marco superior 3 carriles

Superior frame

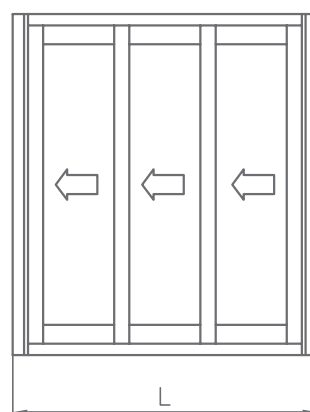
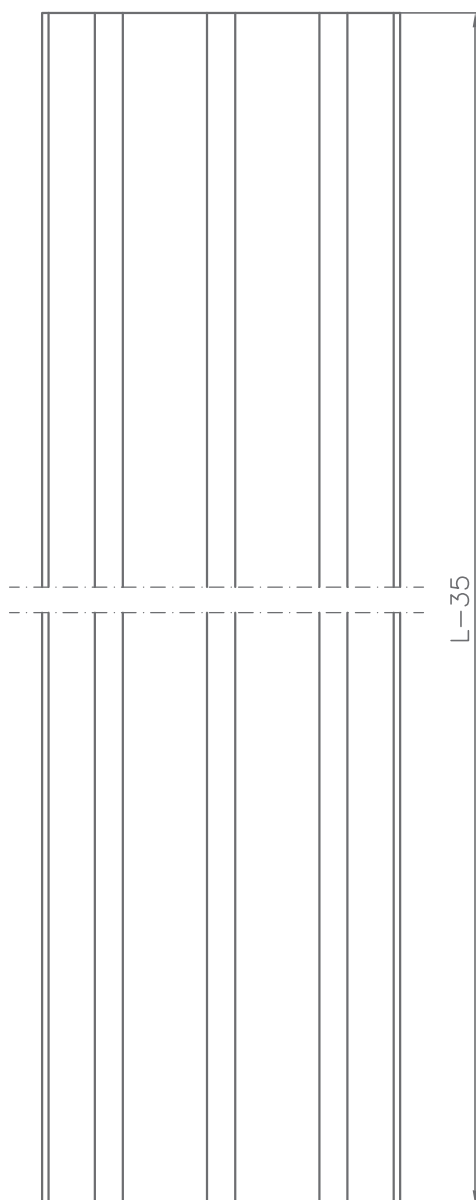
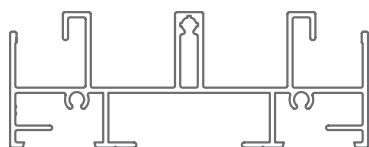



MECANIZADOS | MACHINING

Marco inferior 3 carriles

Inferior frame 3

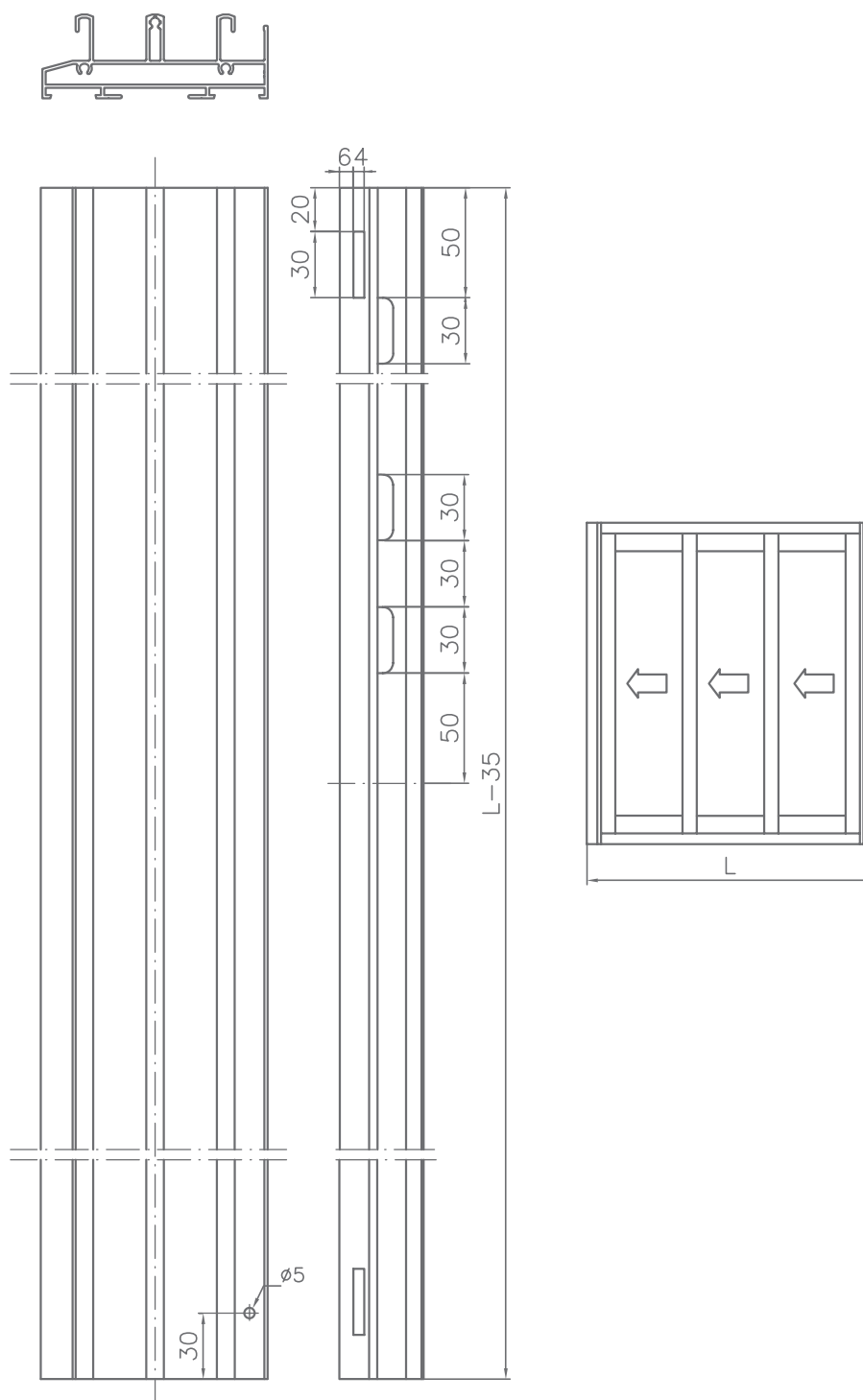



MECANIZADOS | MACHINING

Marco lateral 3 carriles

Lateral frame 3

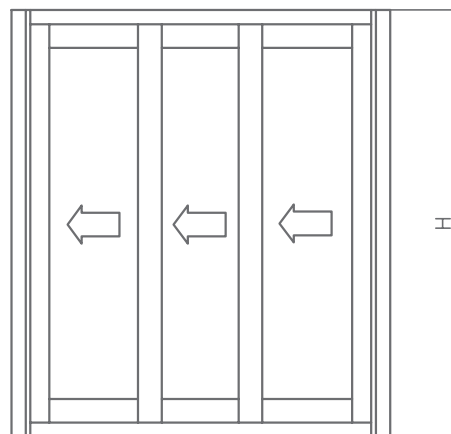
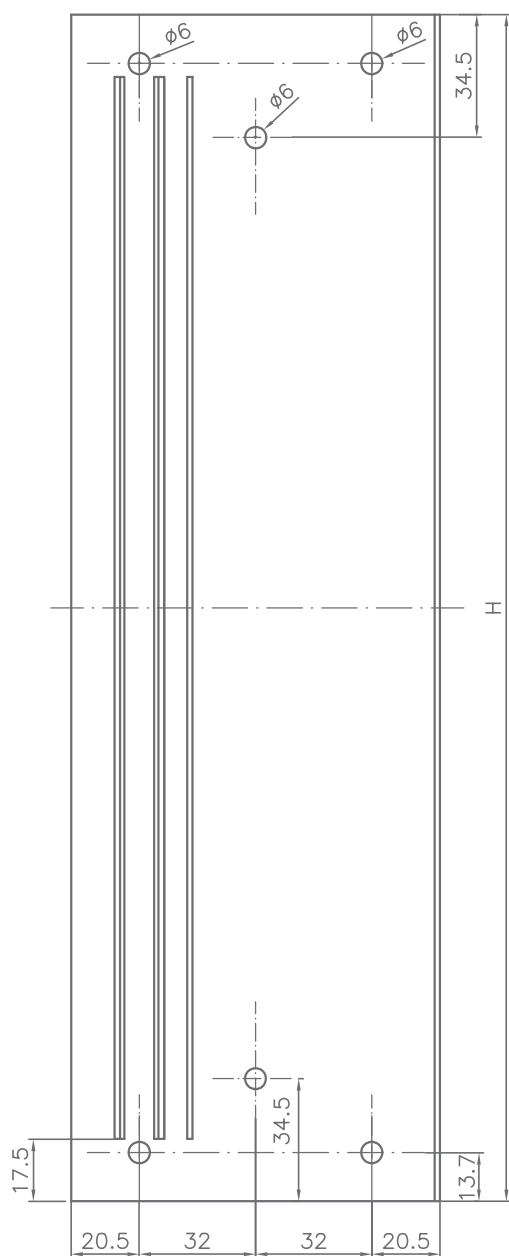



MECANIZADOS | MACHINING

Hoja lateral

Lateral sash

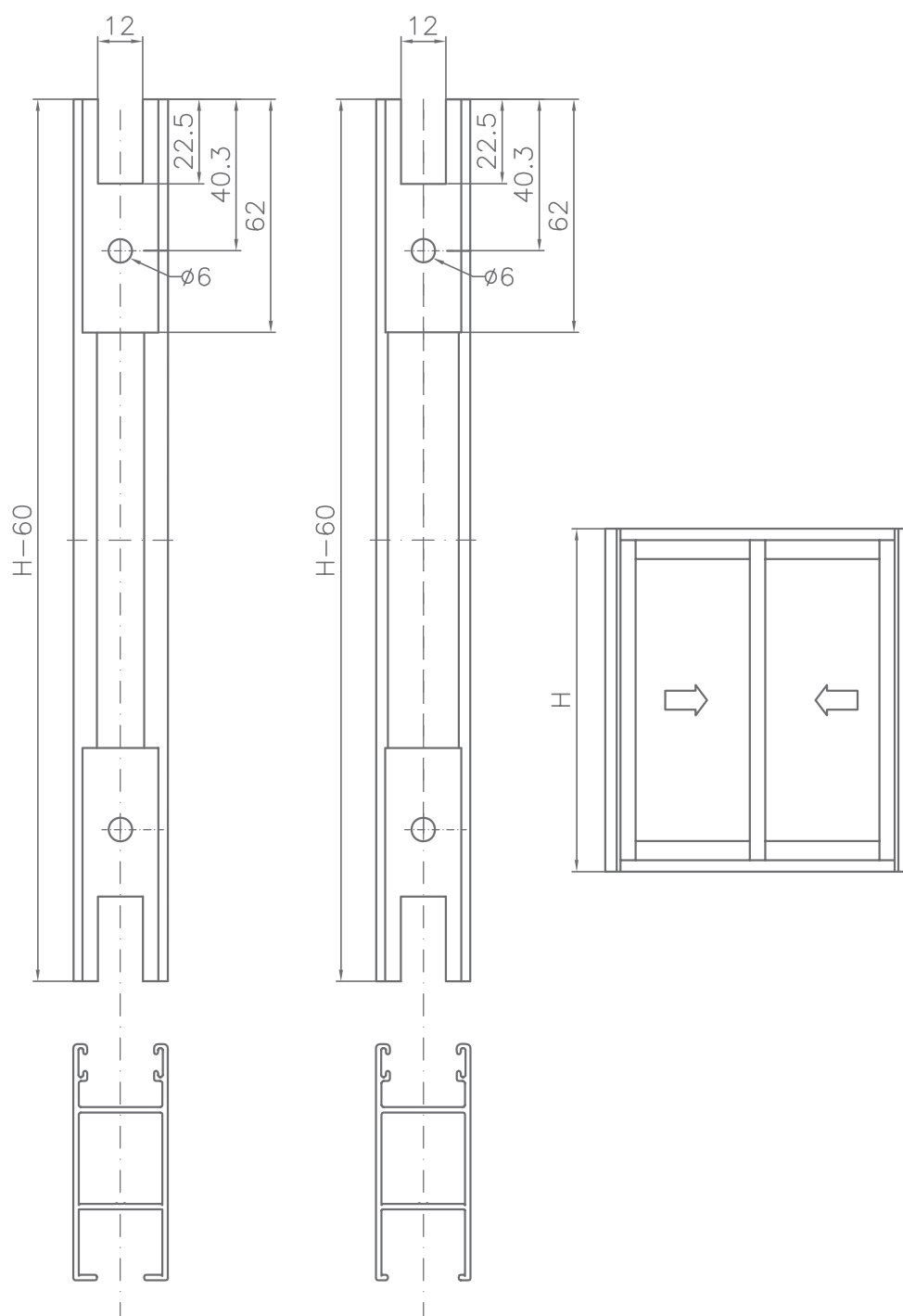



MECANIZADOS | MACHINING

Hoja central

Central sash

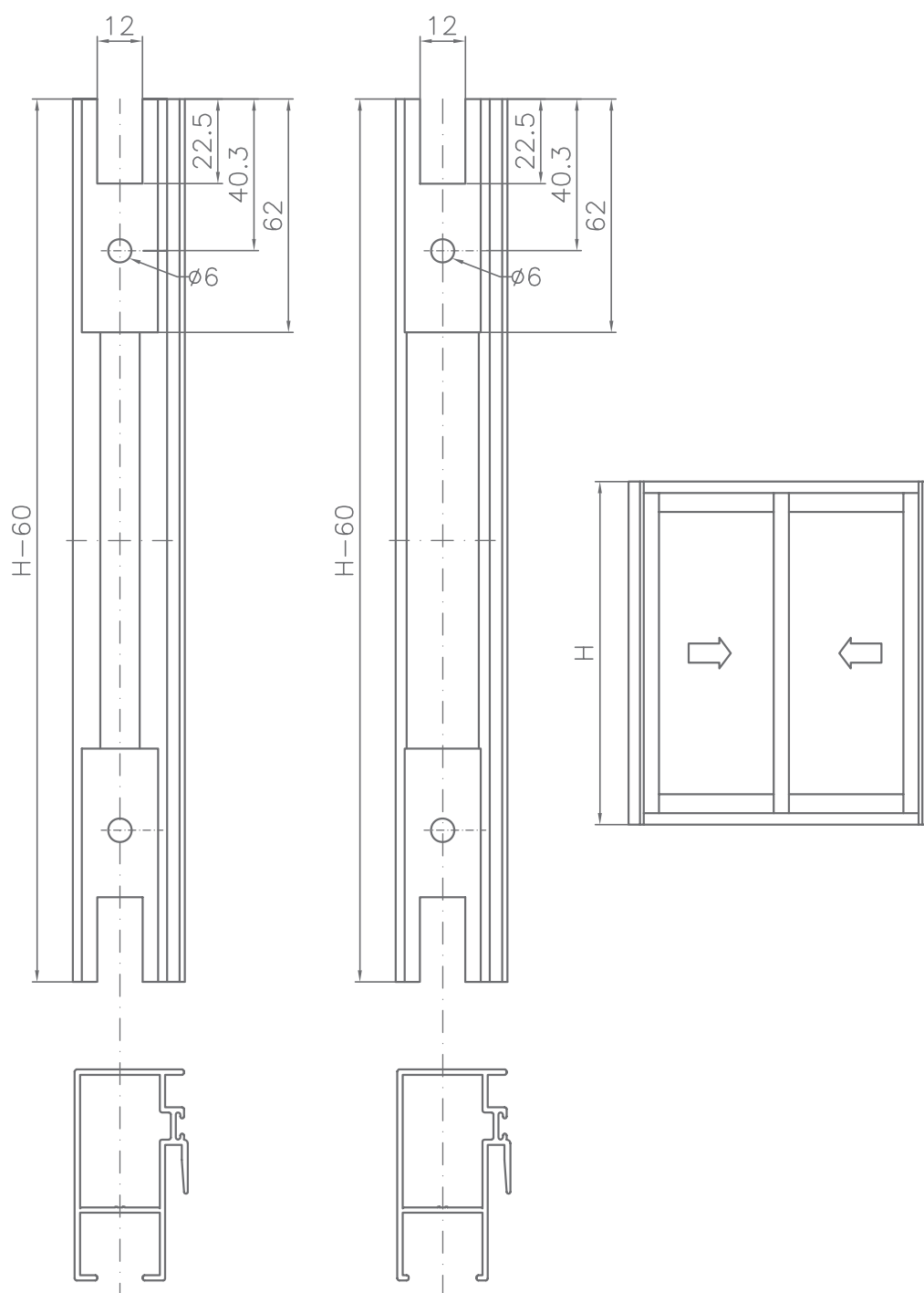



MECANIZADOS | MACHINING

Hoja lateral para zócalo
Lateral sash for skirting board

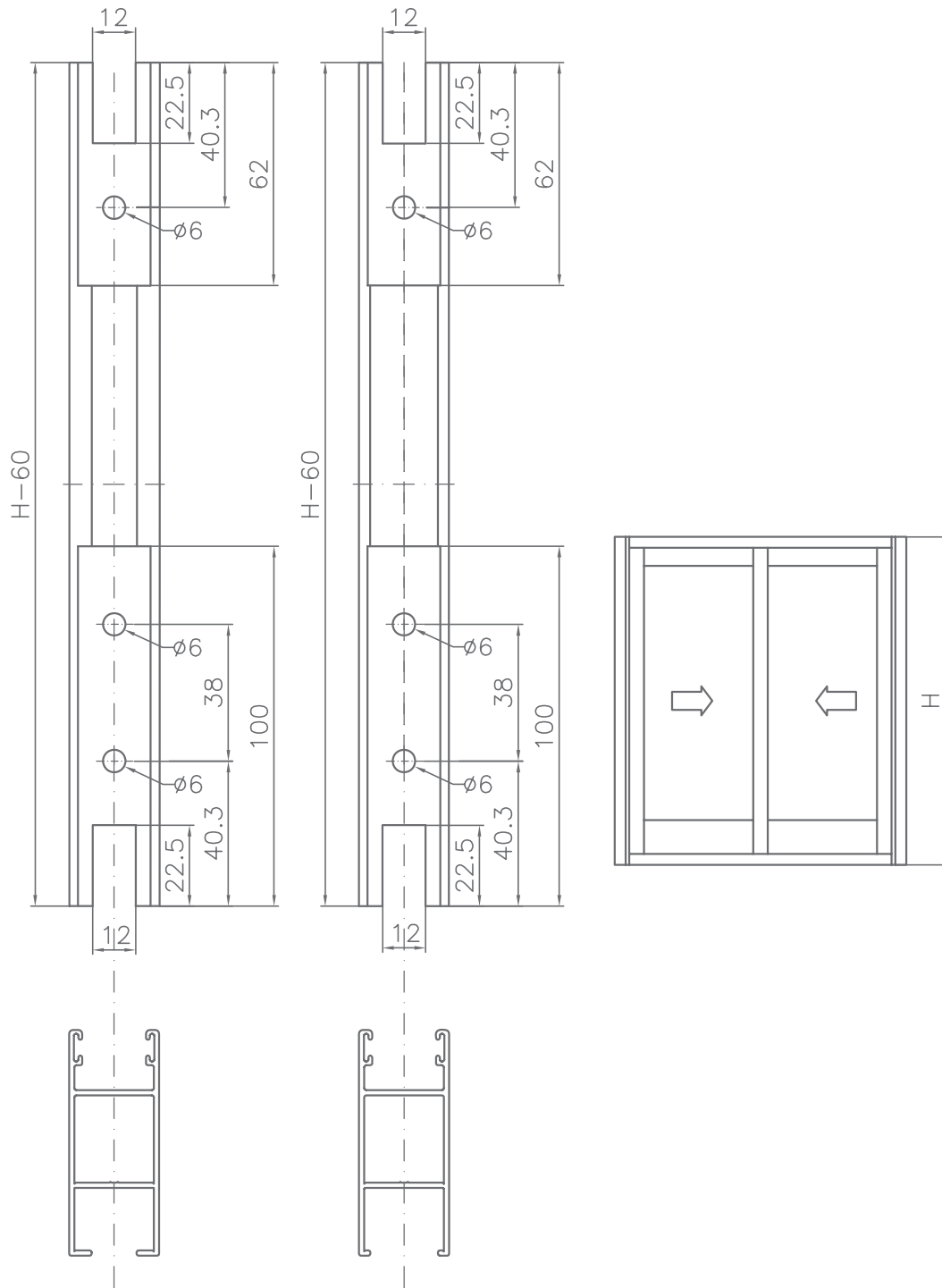



MECANIZADOS | MACHINING

Cierre en hoja lateral
Closing in lateral sash

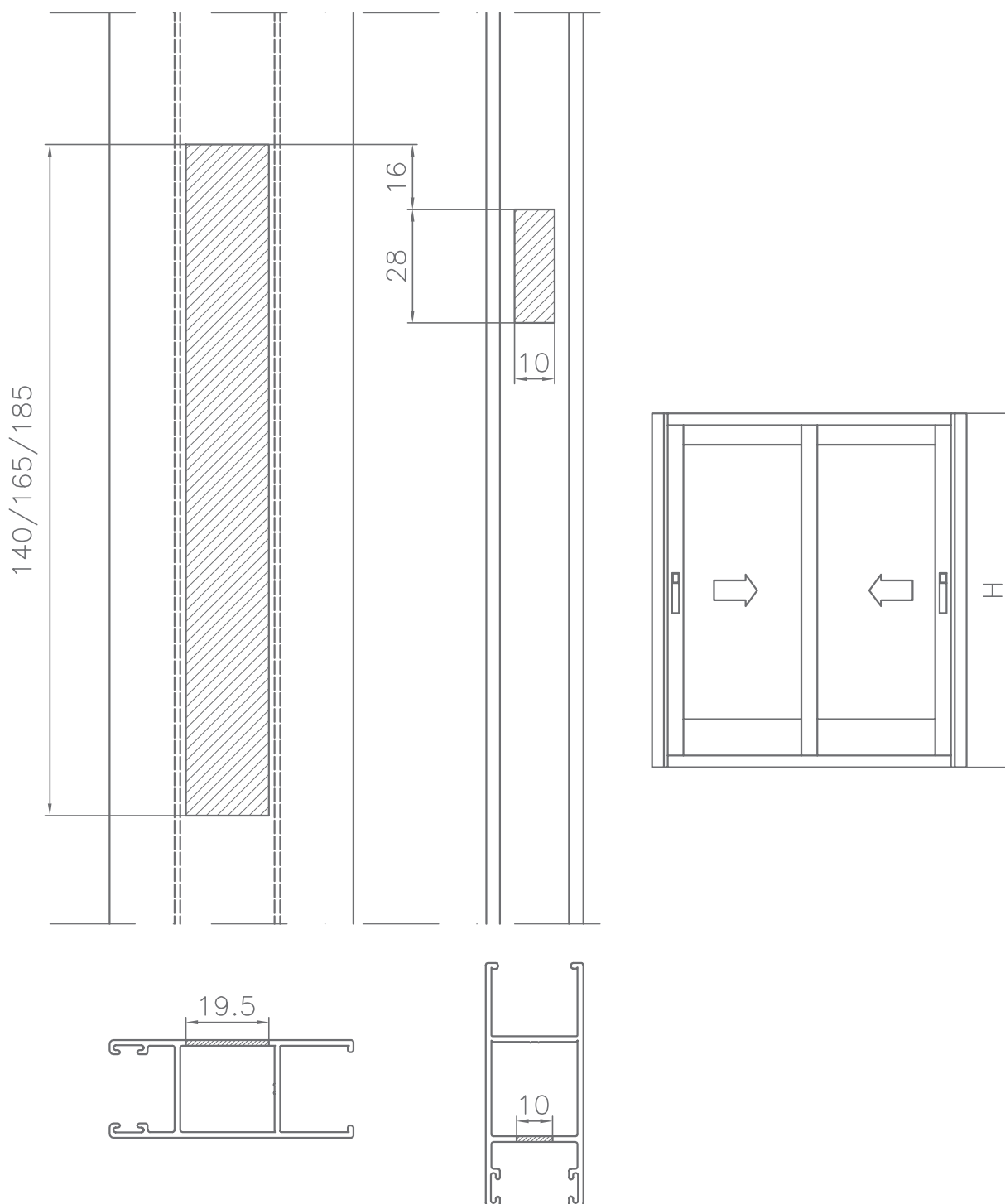



MECANIZADOS | MACHINING

Hoja central para zócalo
Central sash for skirting board

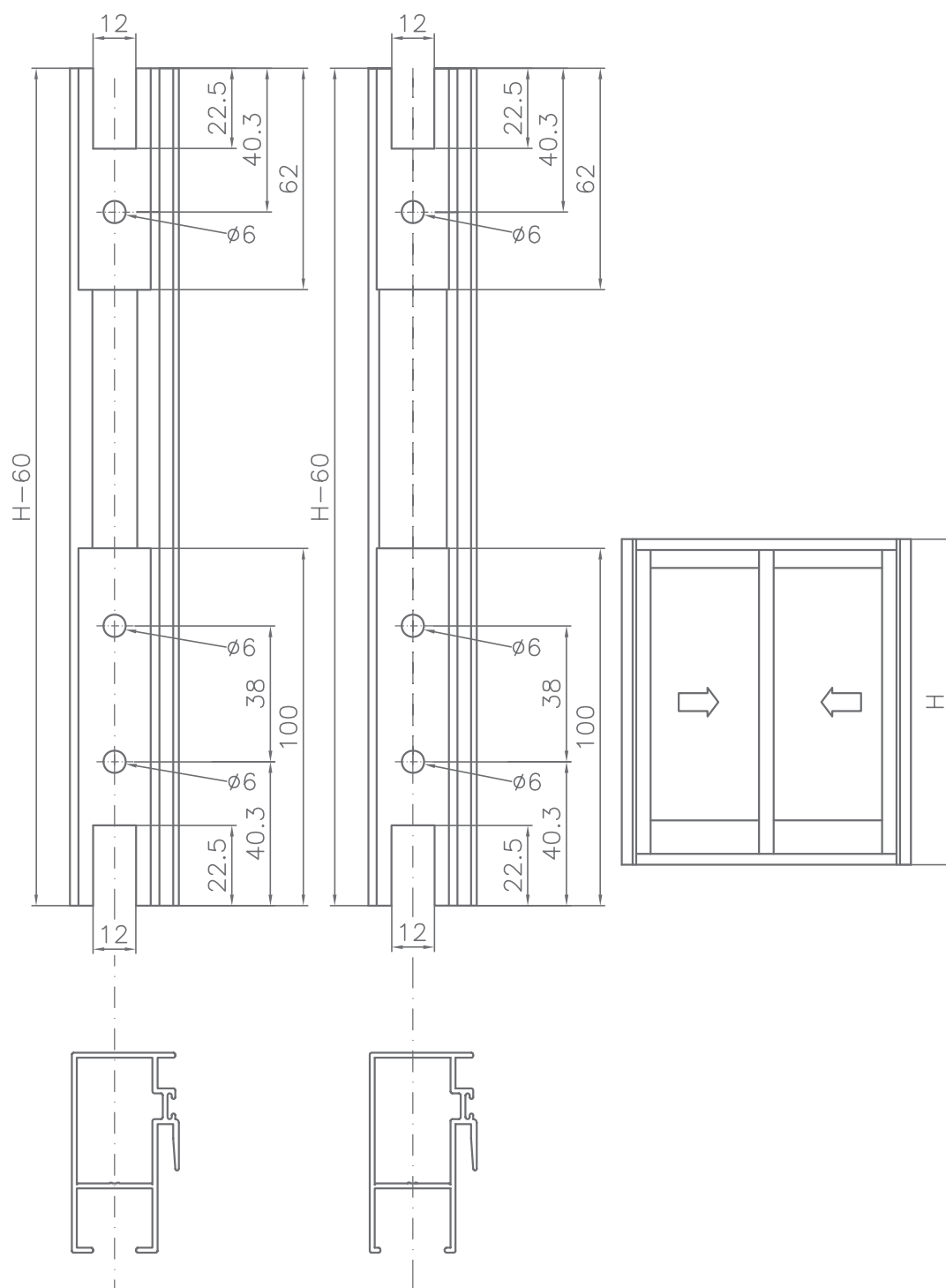



MECANIZADOS | MACHINING

Hoja lateral y central

Lateral sash and central

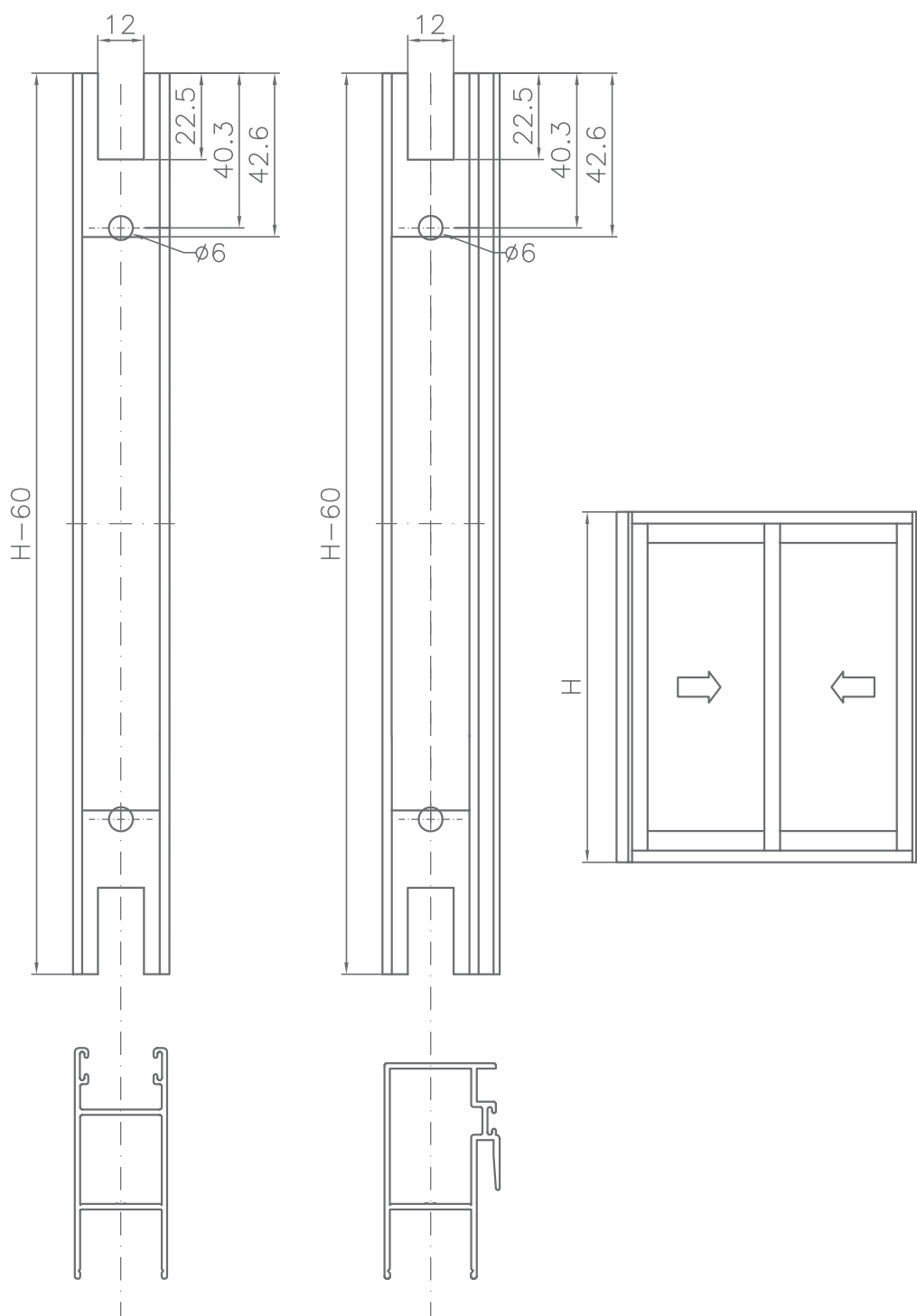



MECANIZADOS | MACHINING

Hoja horizontal, superior e inferior
Horizontal sash, superior and inferior

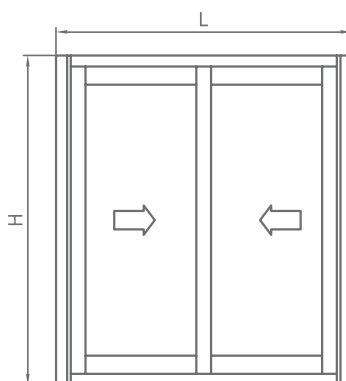

A	700006		
N	700060		
A	700060		
N	700065		
A	700007		
N	700070		
A	700070		
N	700075		
A	700061		
N	700401		
A	700062		<div style="text-align: center;"> <p>L/2-13 (2 Hojas)</p> <p>L/4-4 (4 Hojas)</p> <p>L/3+8 (3 Hojas iguales)</p> <p>2 Hojas laterales (L/3+3) 1 Hoja central (L/3+15)</p> </div>
N	700160		
A	700170		
N	700170		
A	700063		
N	700063		
<div style="border: 1px solid black; padding: 2px; display: inline-block;"> <p>(3 Hojas mismo cristal)</p> </div>			

A: Ref. antigua
N: Ref. nueva



MECANIZADOS | MACHINING

Hojas horizontales

Horizontal sash

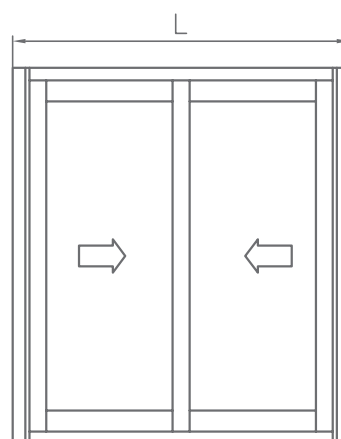
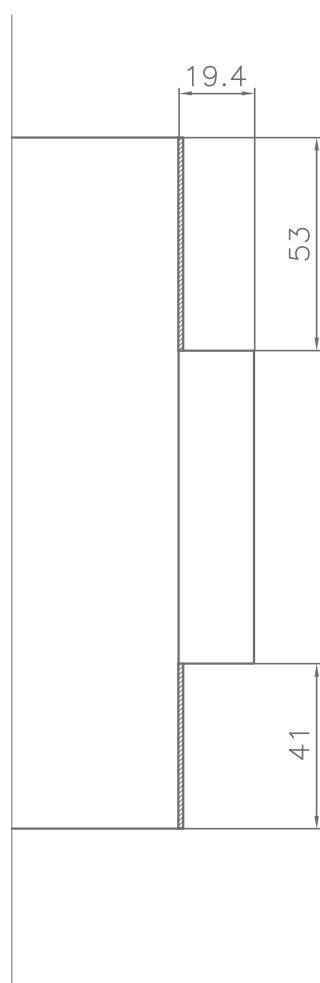
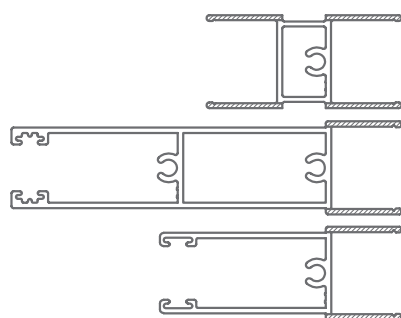



MECANIZADOS | MACHINING

Marco fijo horizontal y vertical
Fix horizontal and vertical frame

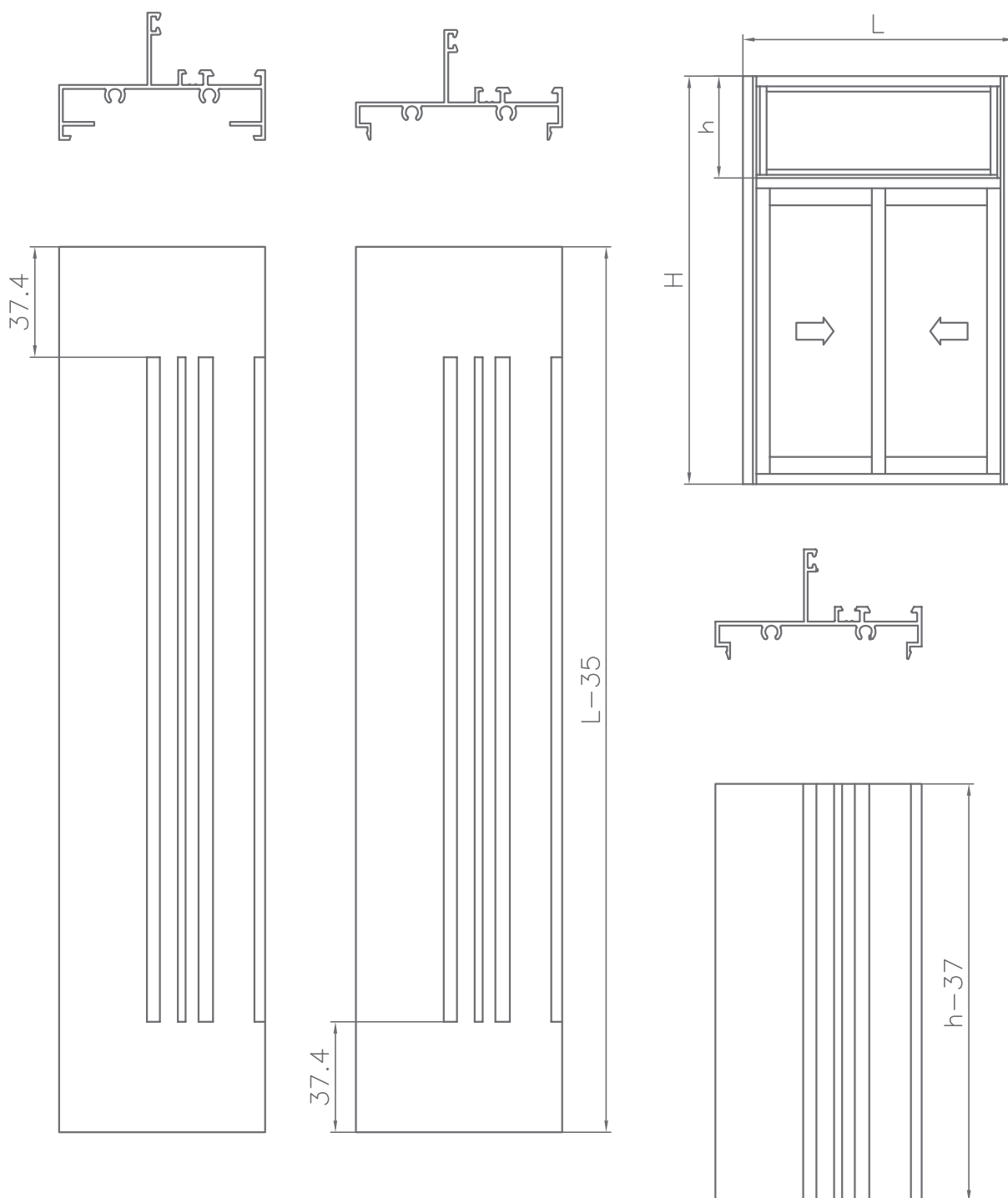



MECANIZADOS | MACHINING

Marco lateral con guía

Lateral frame with guide

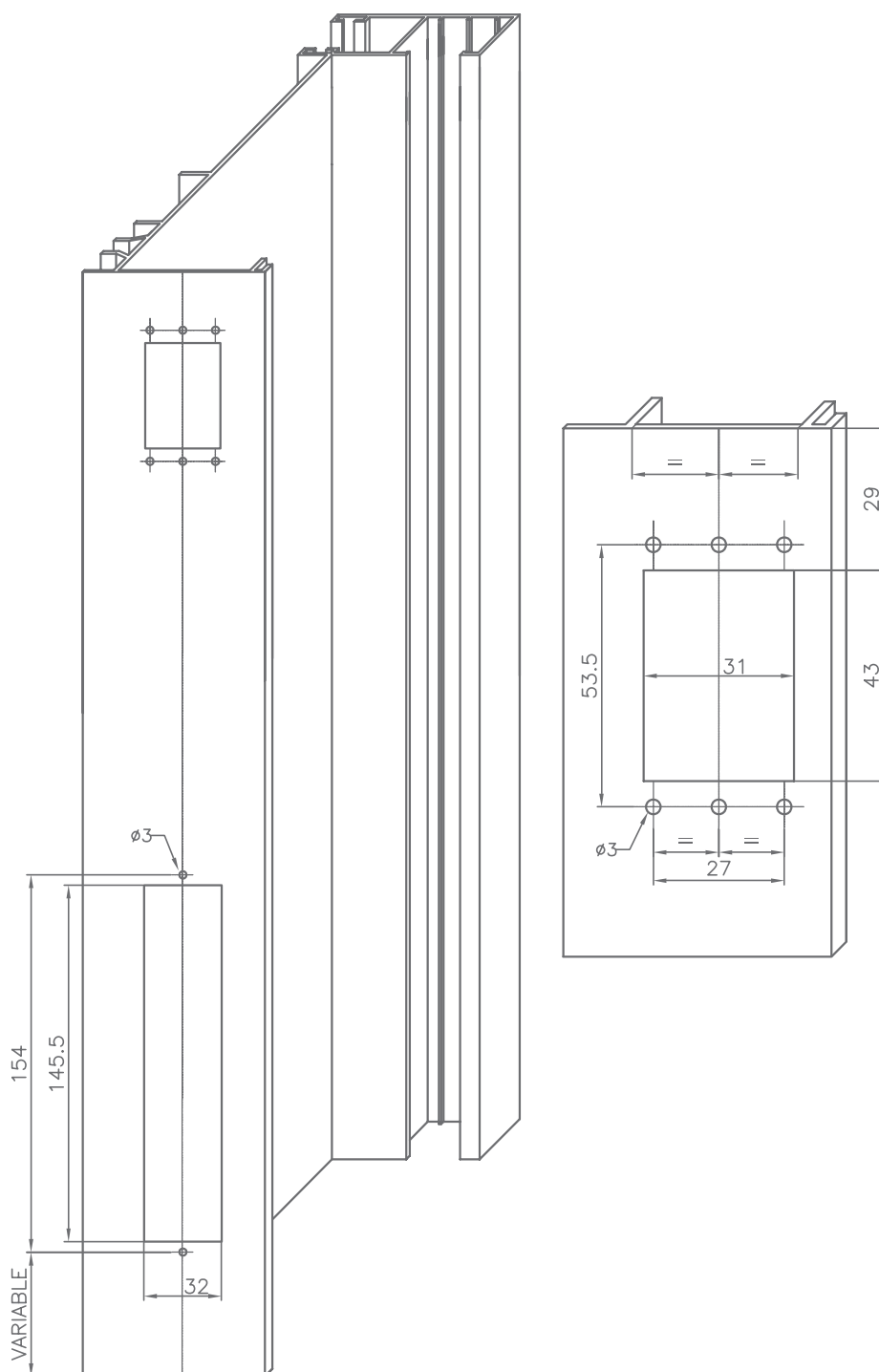



**HIERROS
JÁTIVA**

CENTRAL

Pol.Ind. "La Vila" Parcela 5.
46819 / Novetlé / Valencia (Spain)
administracion@hierrosjativa.com

Tel.: 96 227 08 00
Fax.: 96 227 41 63
HIERRO: 678 255 770
ALUMINIO: 678 252 153

.....

DELEGACIÓN ALICANTE

Pol.Ind. I-8, Calle Catral
033330 / Crevillente / Alicante (Spain)
crevillente@hierrosjativa.com

Tel.: 96 540 45 61
Fax.: 96 540 46 45

.....

DELEGACIÓN ZARAGOZA

Alfredo Abad

alfredoberdusan@gmail.com
Tel.: 647 576 092