



Machining

Mecanizados



Machining - Mecanizado

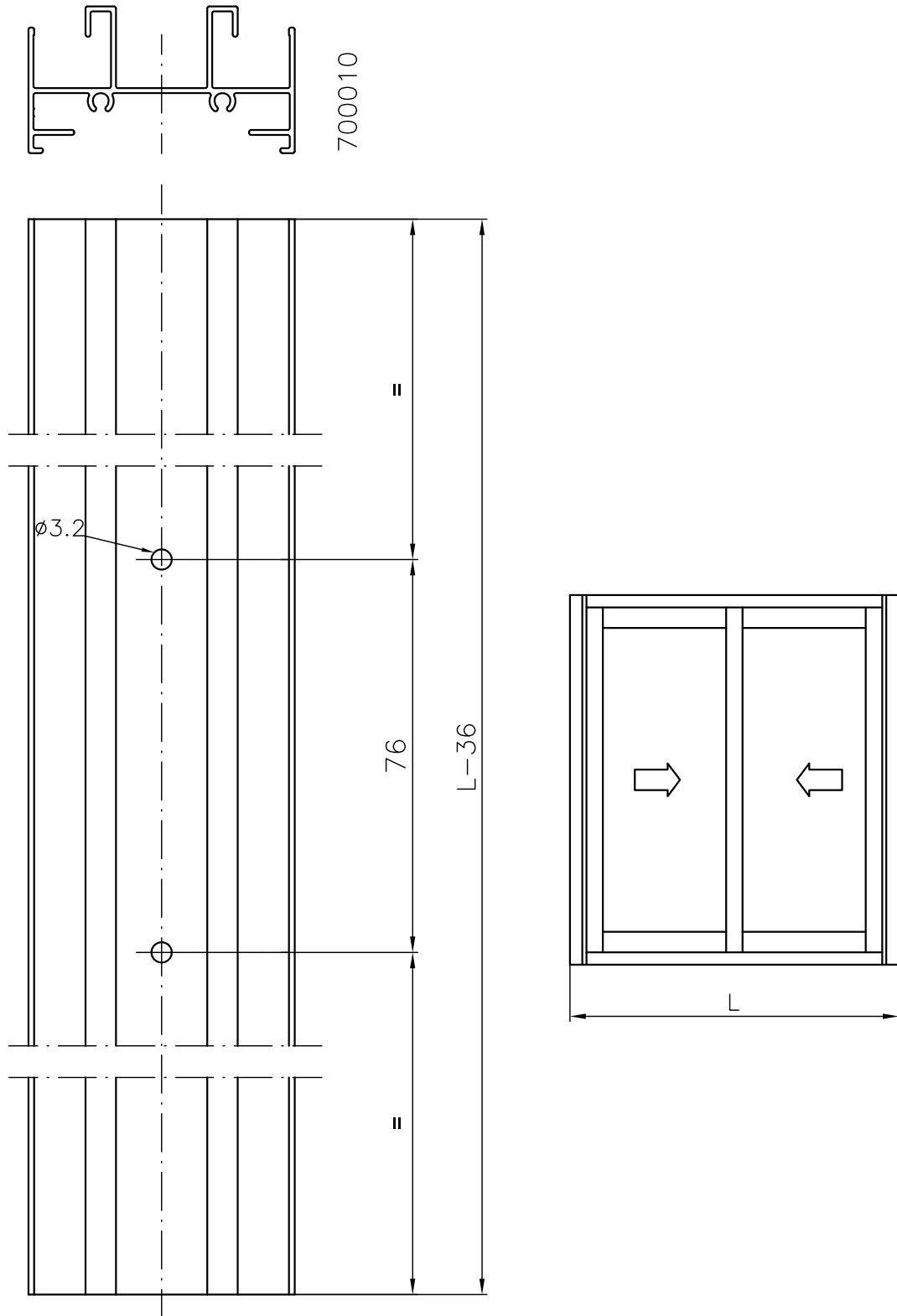

SUPERIOR FRAME
MARCO SUPERIOR

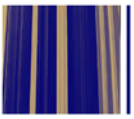

Machining - Mecanizado

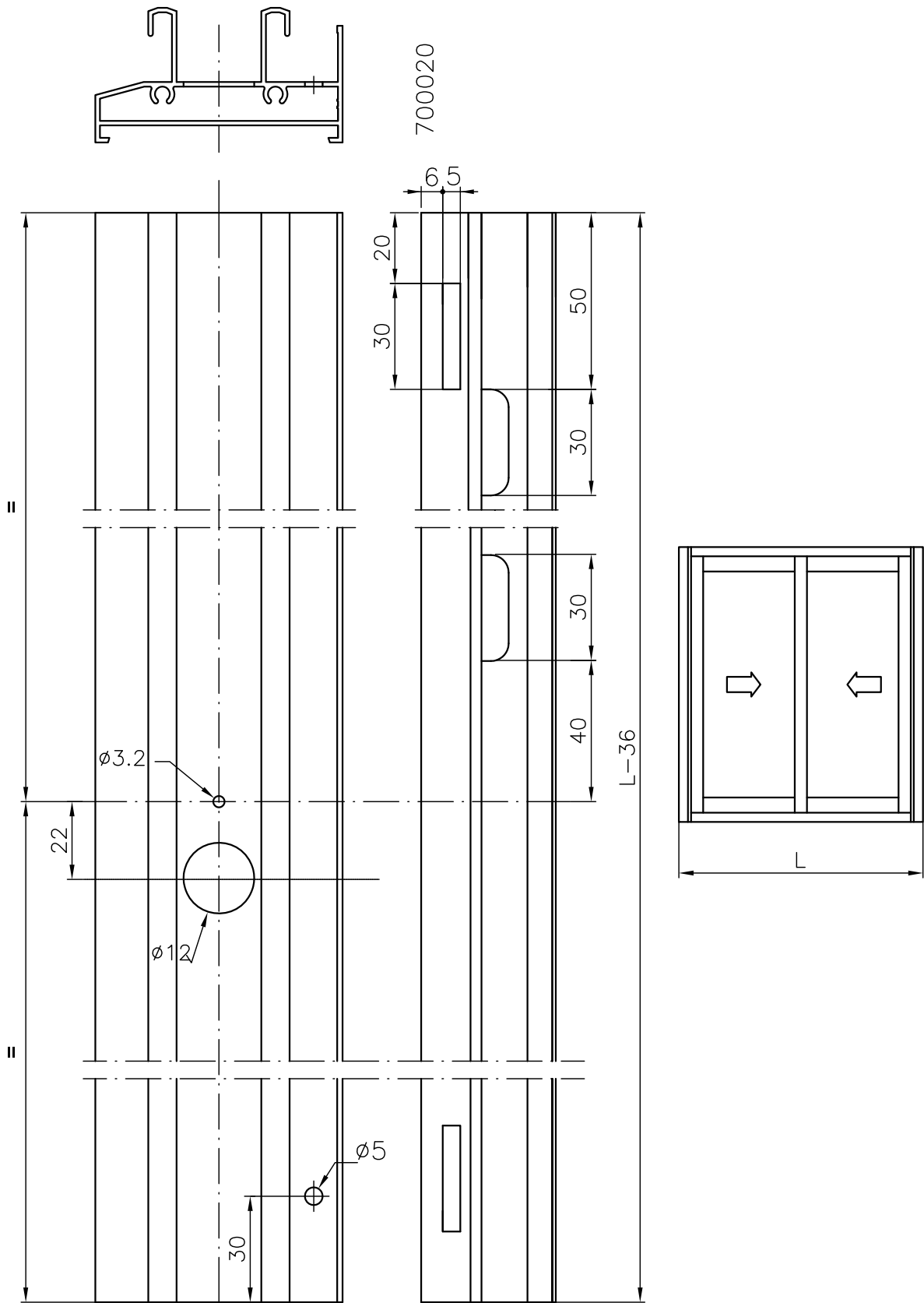

INFERIOR FRAME

MARCO INFERIOR

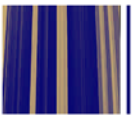

Machining - Mecanizado

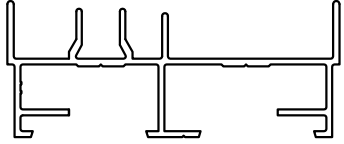

700030

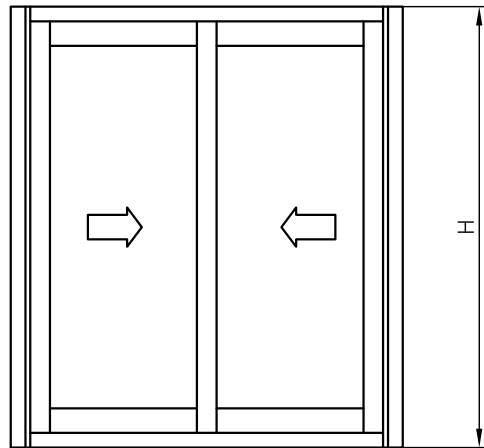
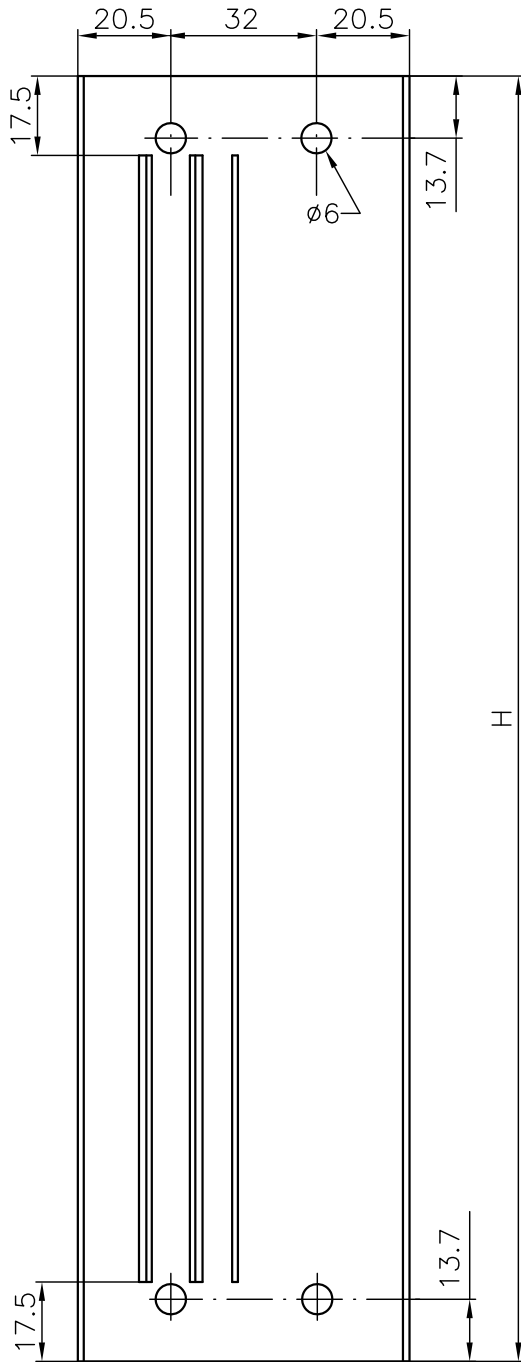

LATERAL FRAME

MARCO LATERAL

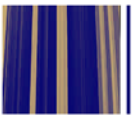

Machining - Mecanizado

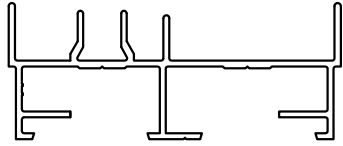

700030

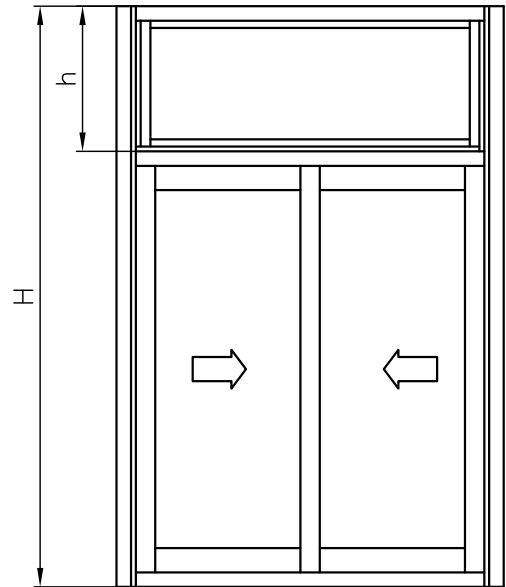
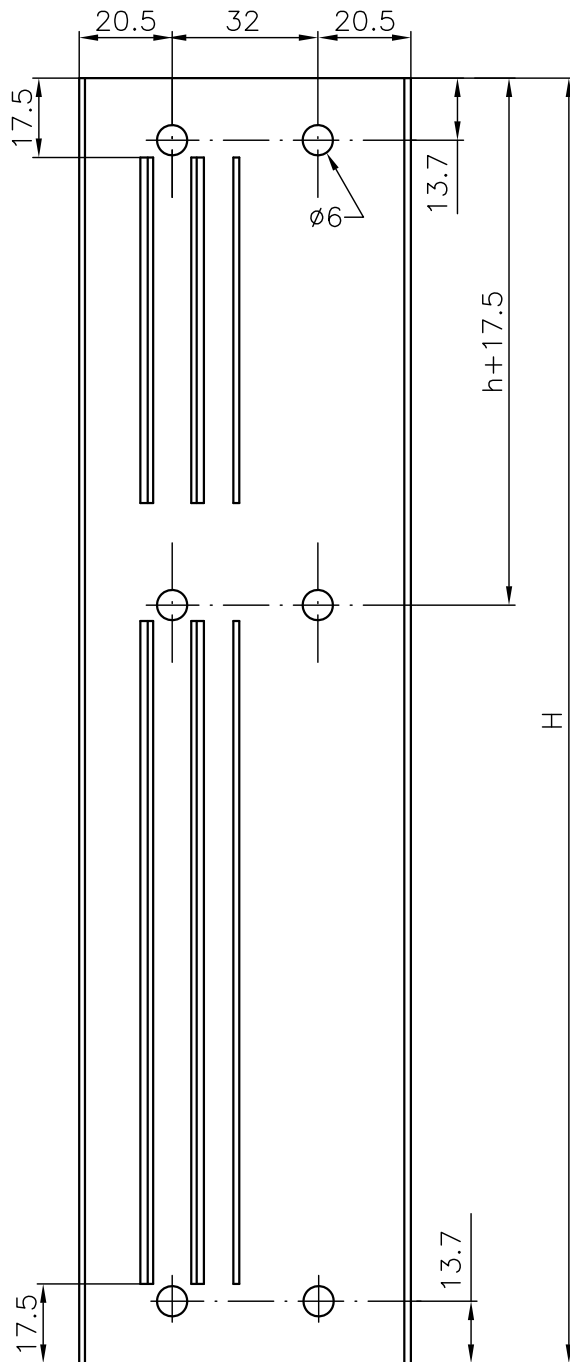

LATERAL FRAME WITH FIXED

MARCO LATERAL CON FIJO

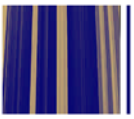

Machining - Mecanizado

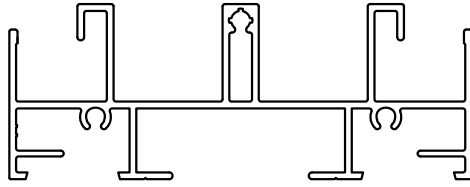

700310

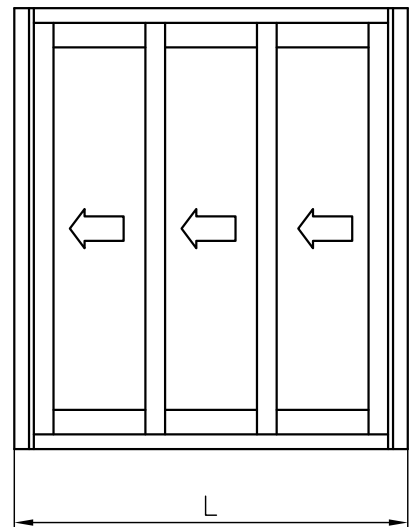
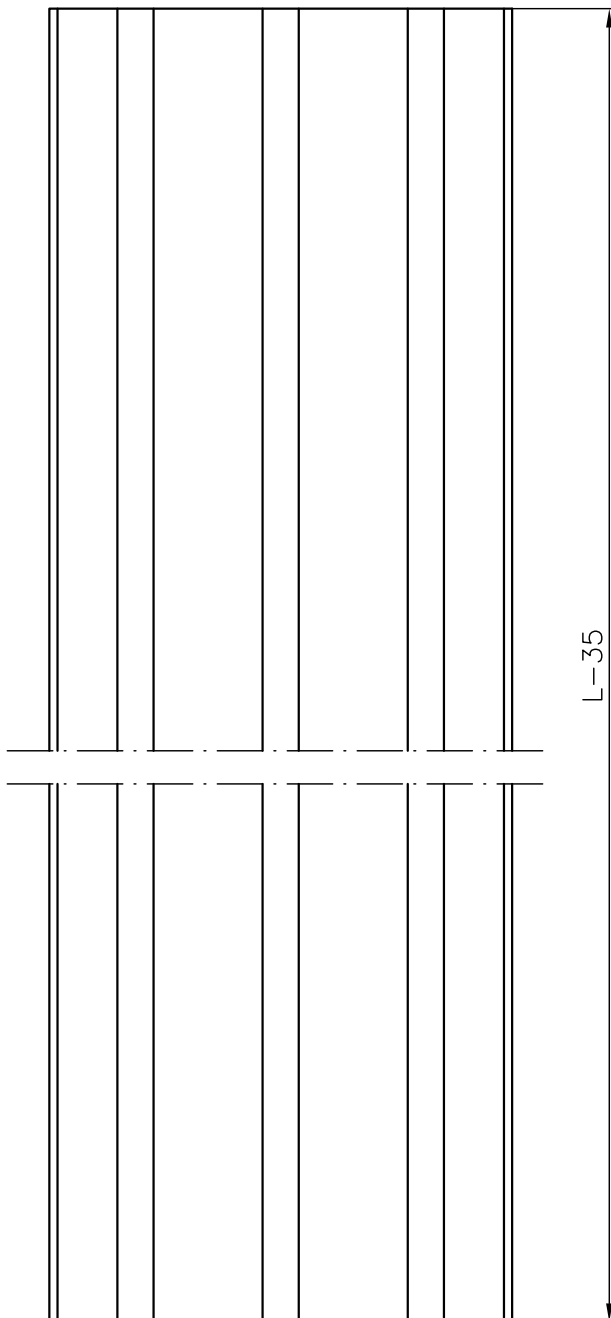

THREE WAYS SUPERIOR FRAME

MARCO SUPERIOR TRES CARRILES

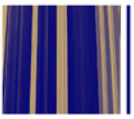

Machining - Mecanizado

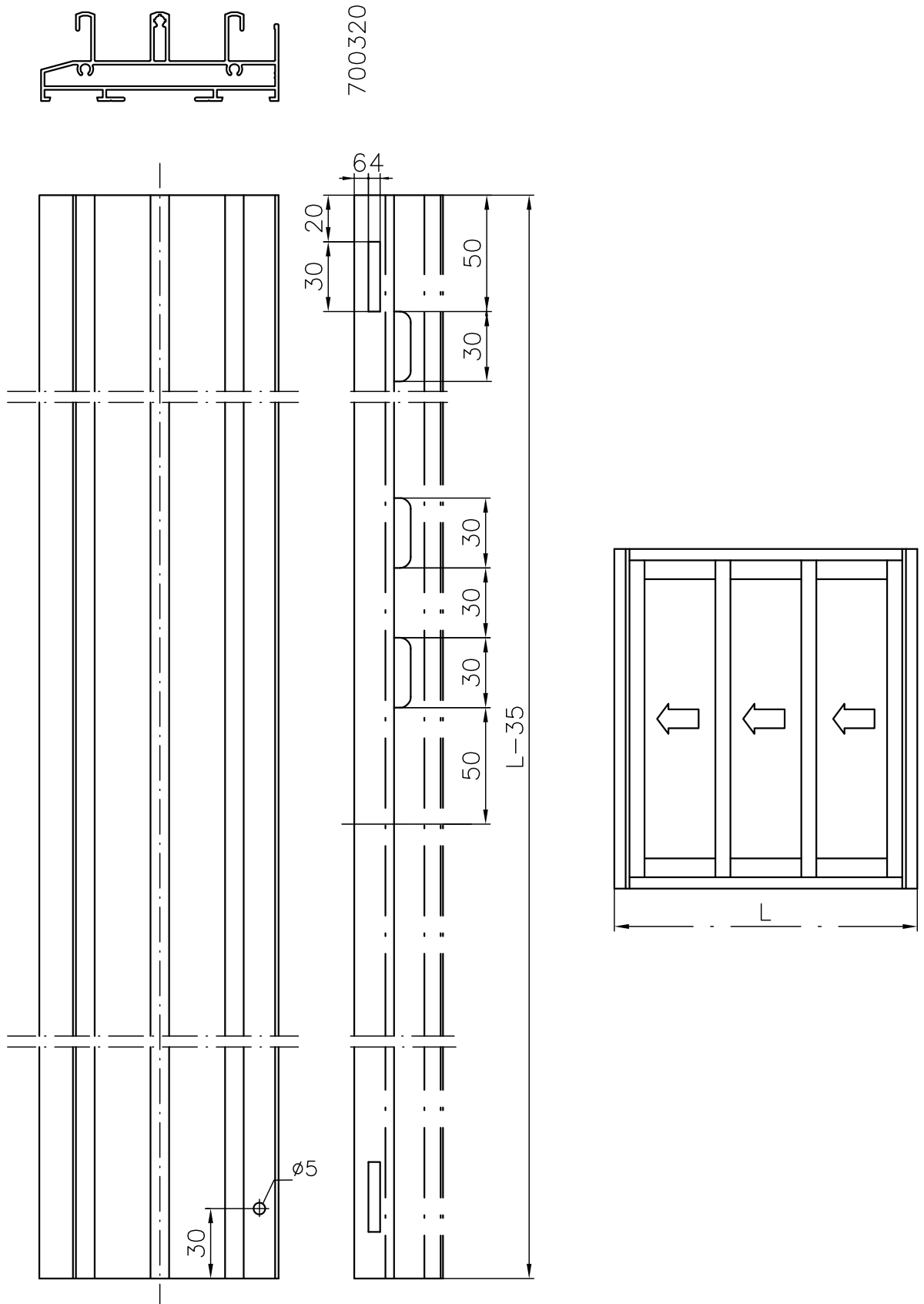

THREE WAYS INFERIOR FRAME

MARCO INFERIOR TRES CARRILES

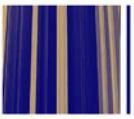

Machining - *Mecanizado*

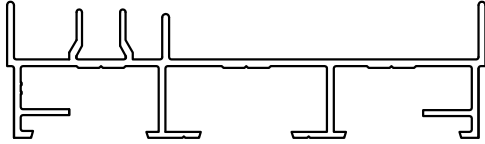

700330

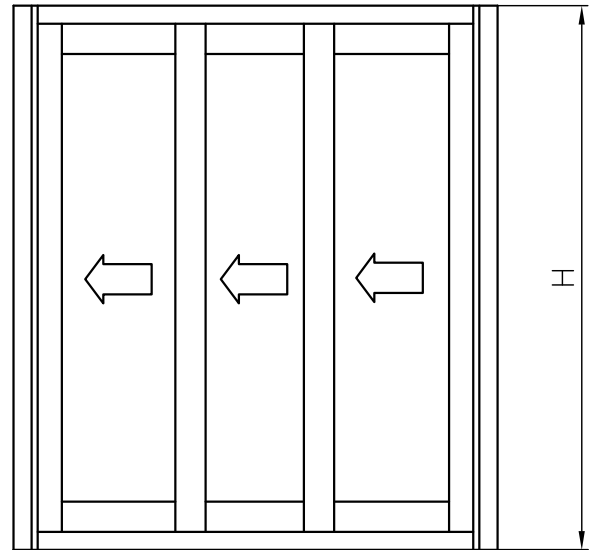
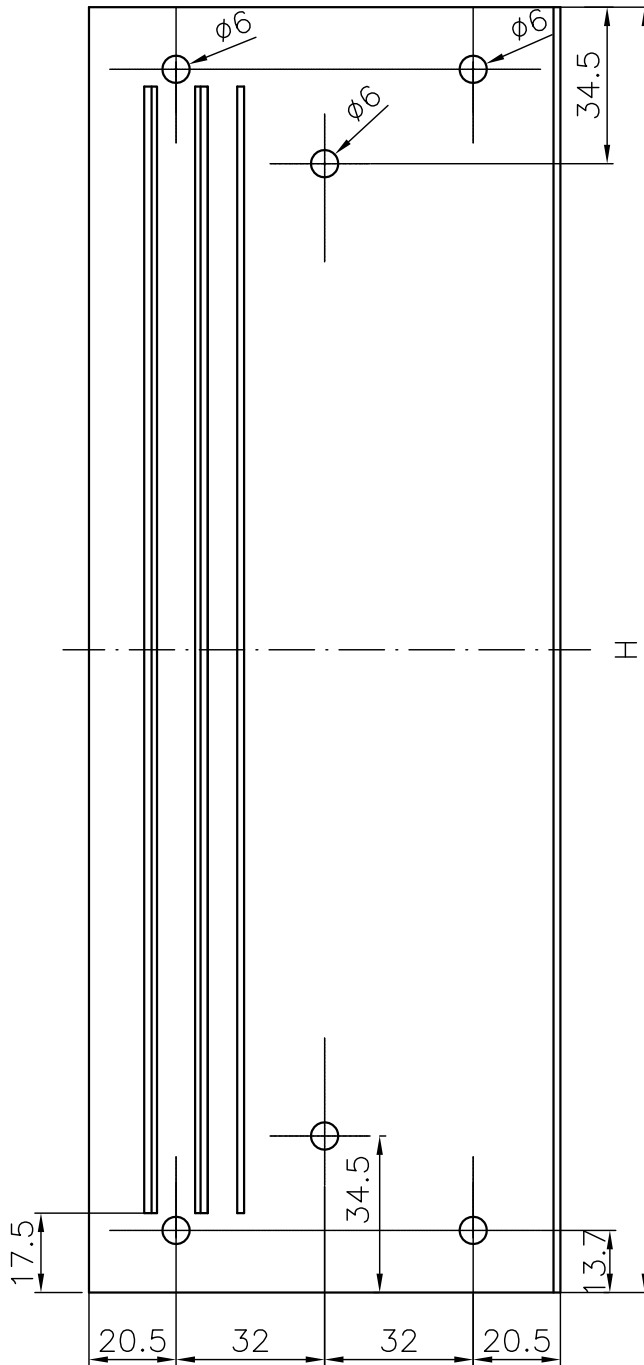

THREE WAYS LATERAL FRAME

MARCO LATERAL TRES CARRILES

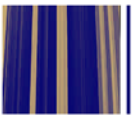

Machining - Mecanizado

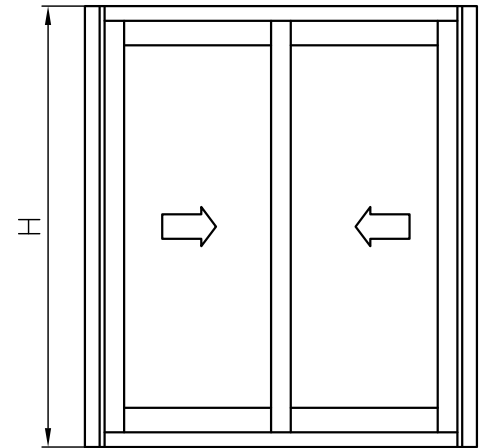
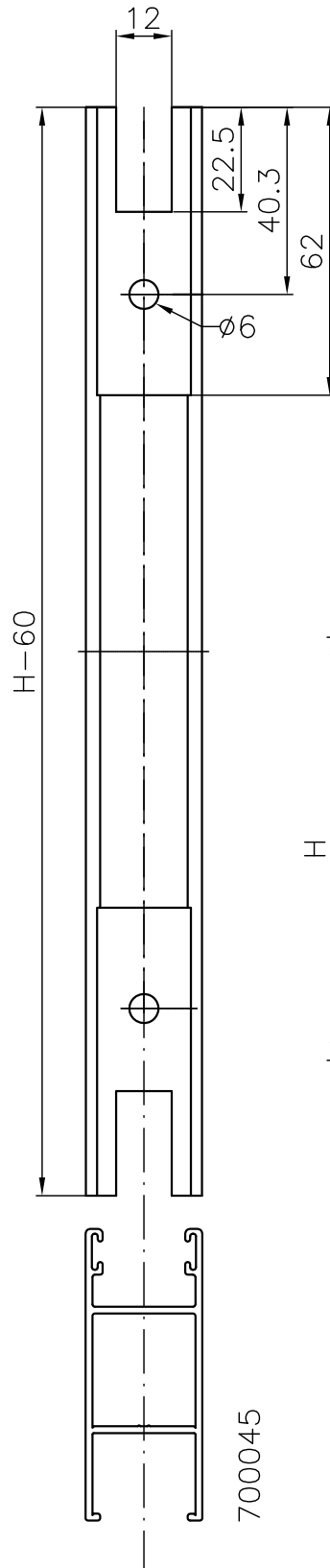
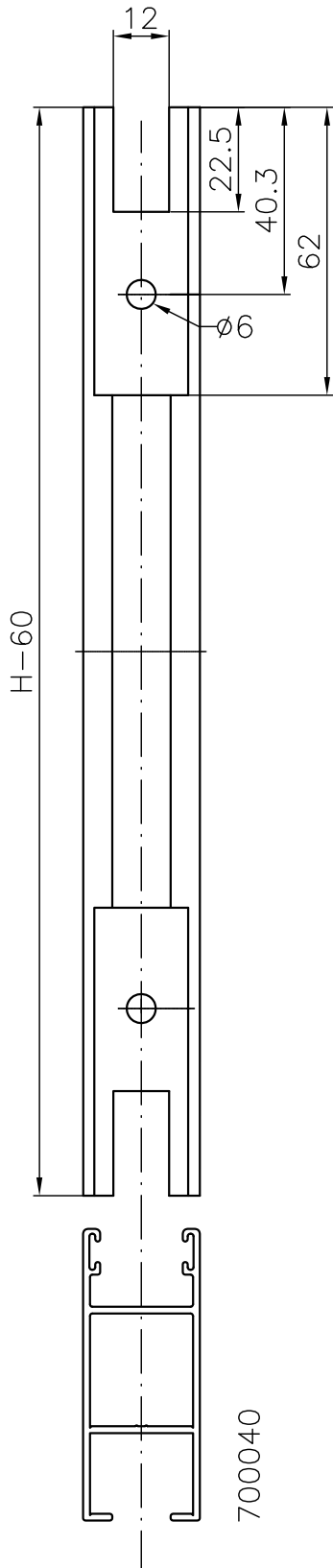

LATERAL SASH

HOJA LATERAL

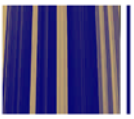

Machining - Mecanizado

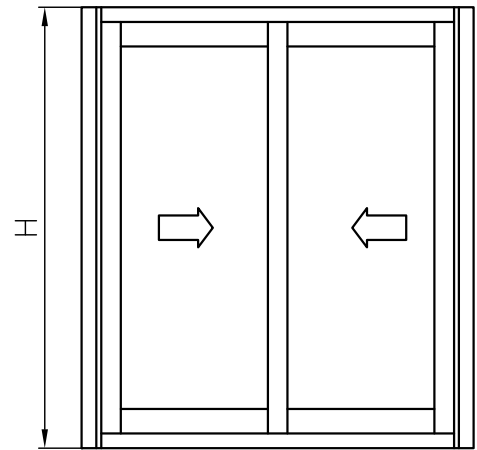
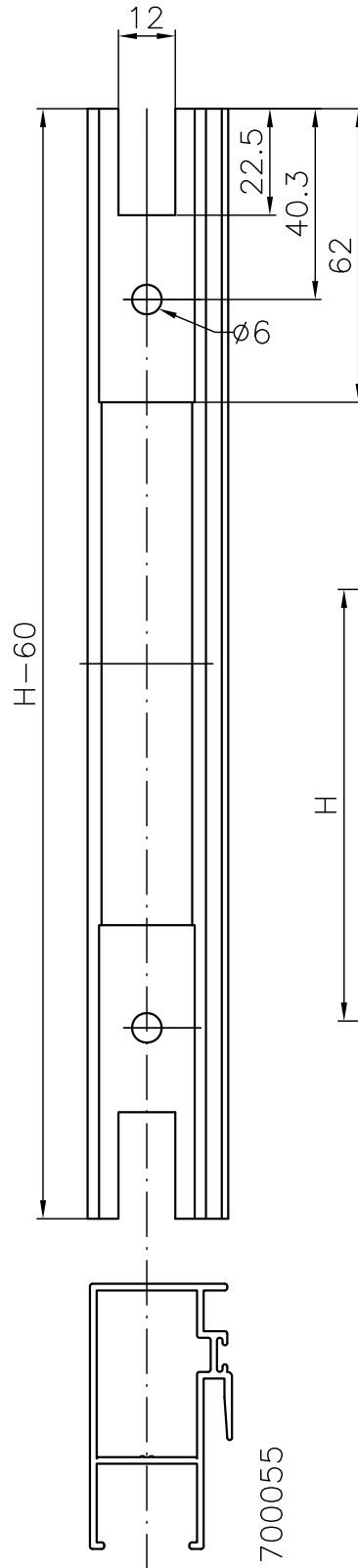
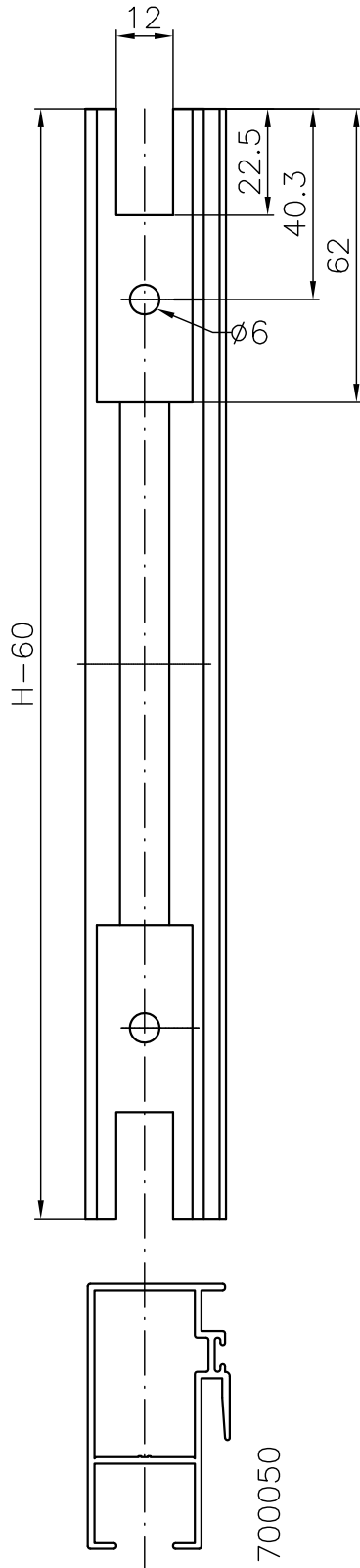

CENTRAL SASH

HOJA CENTRAL

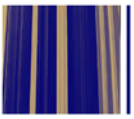

Machining - Mecanizado

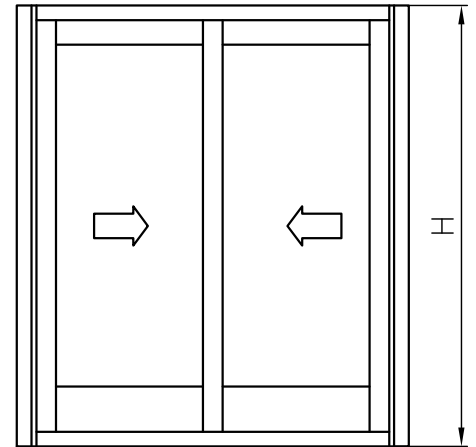
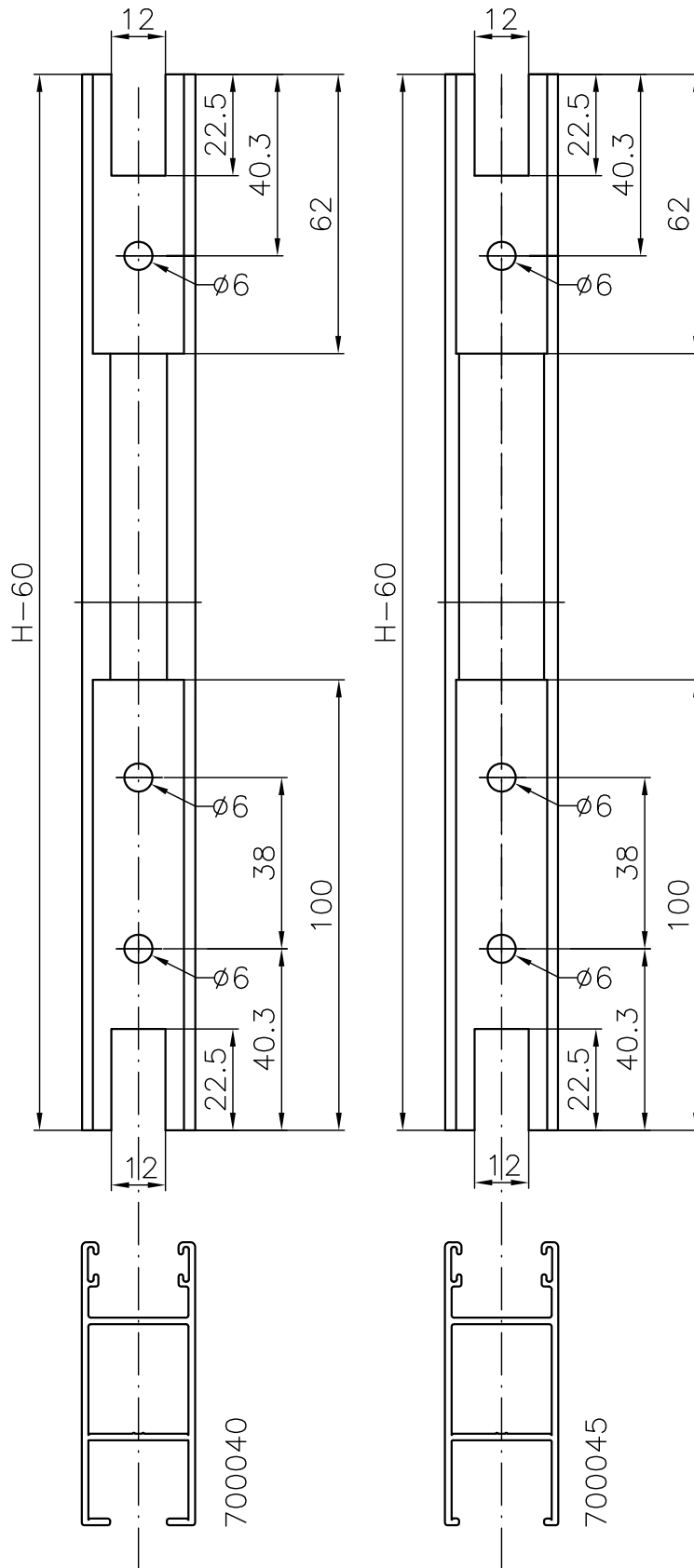

LATERAL SASH WITH SKIRTING BOARD

HOJA LATERAL CON ZOCALO

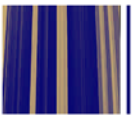

Machining - Mecanizado

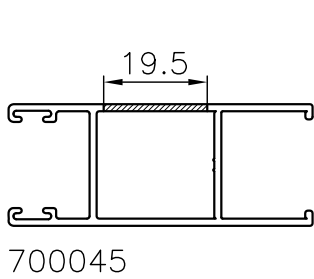
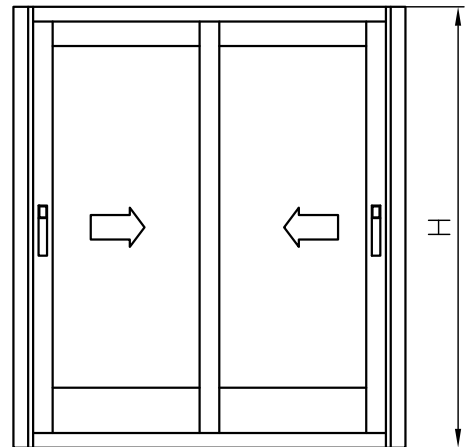
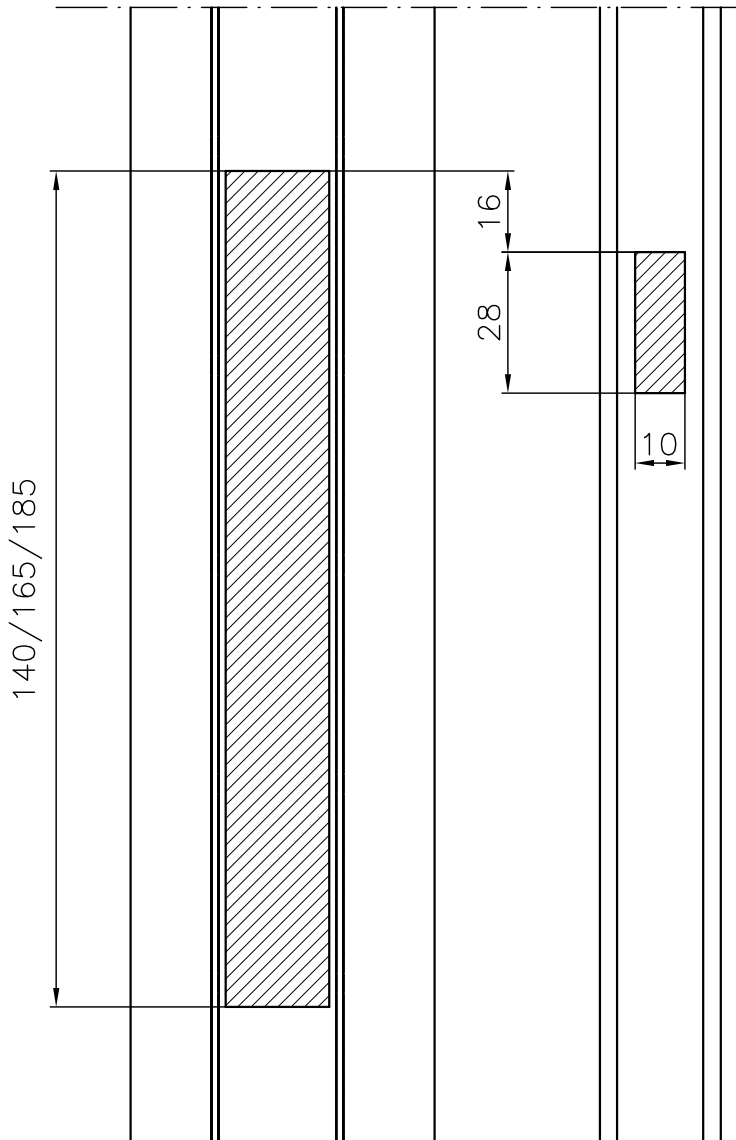

700045

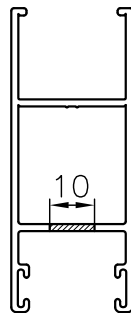

700045

LOCK MACHINING ON LATERAL SASH

MECANIZADO DEL CIERRE EN LA HOJA LATERAL



Machining - Mecanizado

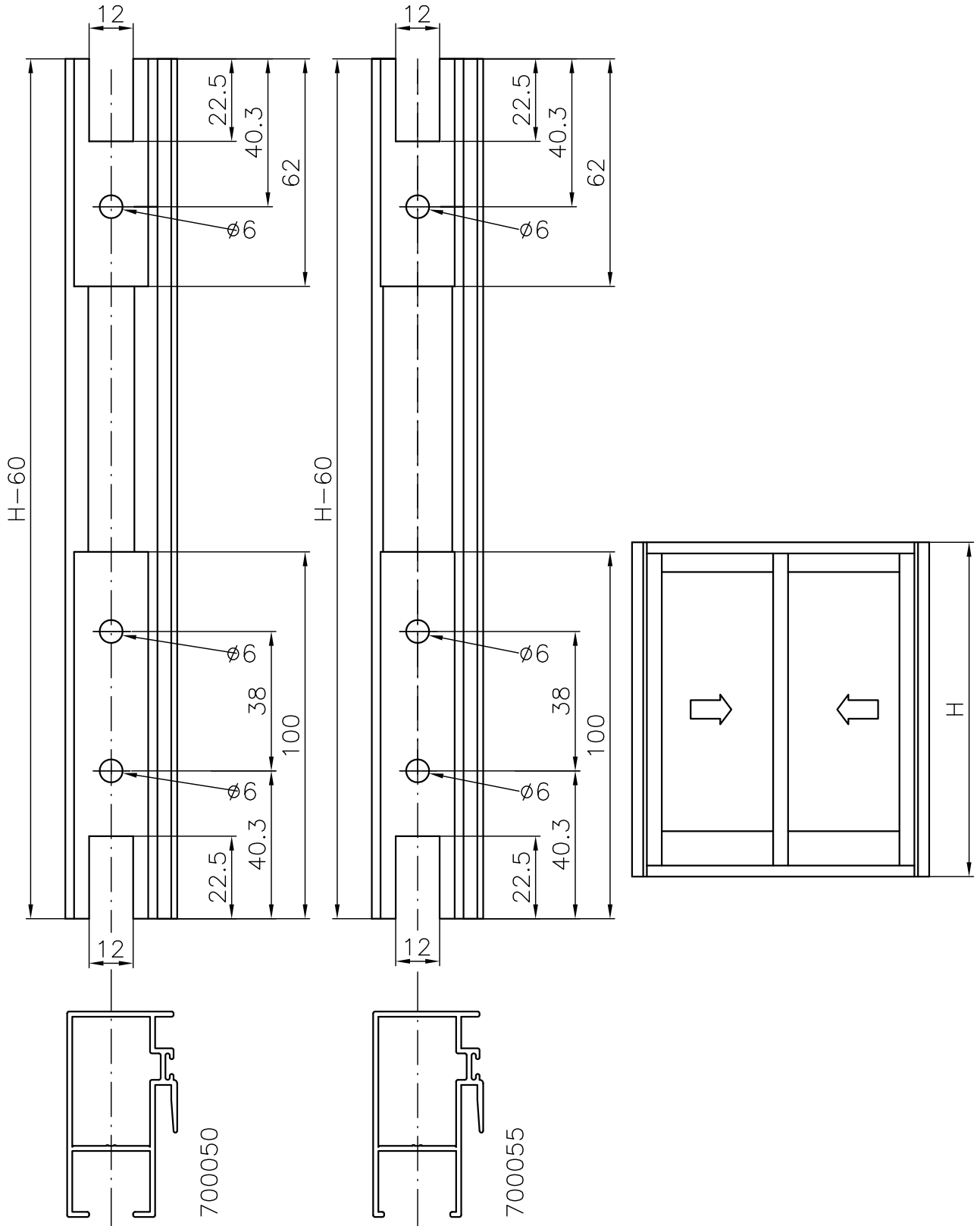

CENTRAL SASH WITH SKIRTING BOARD

HOJA CENTRAL CON ZOCALO

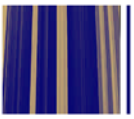

Machining - Mecanizado

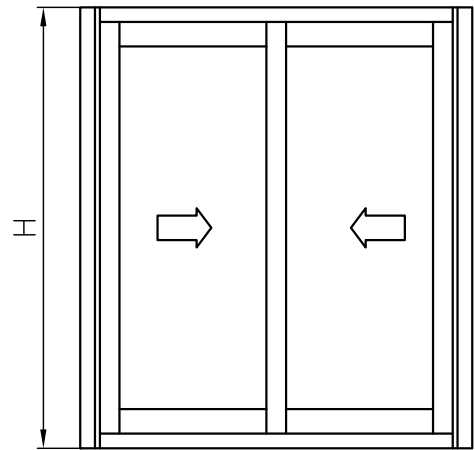
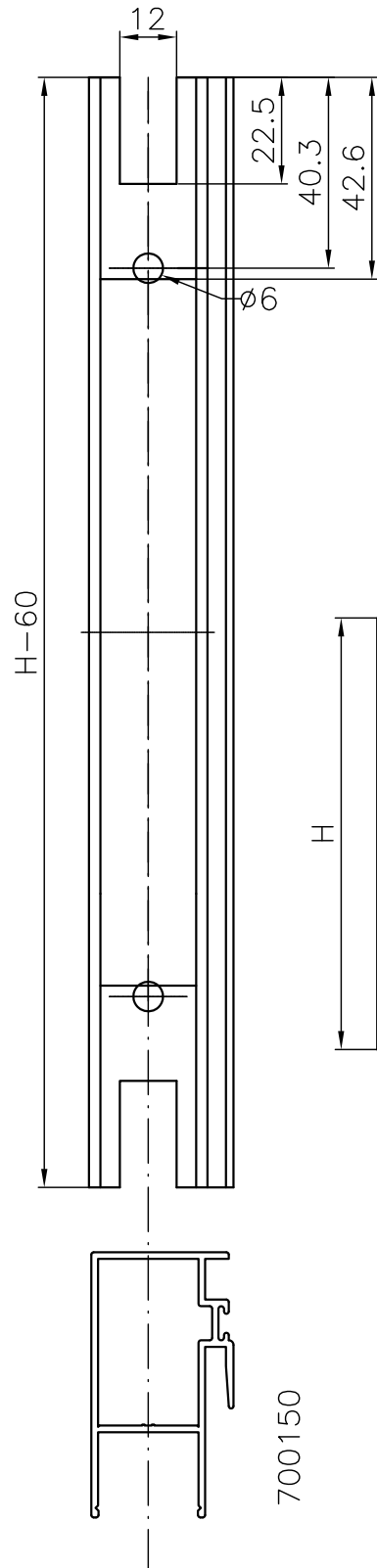
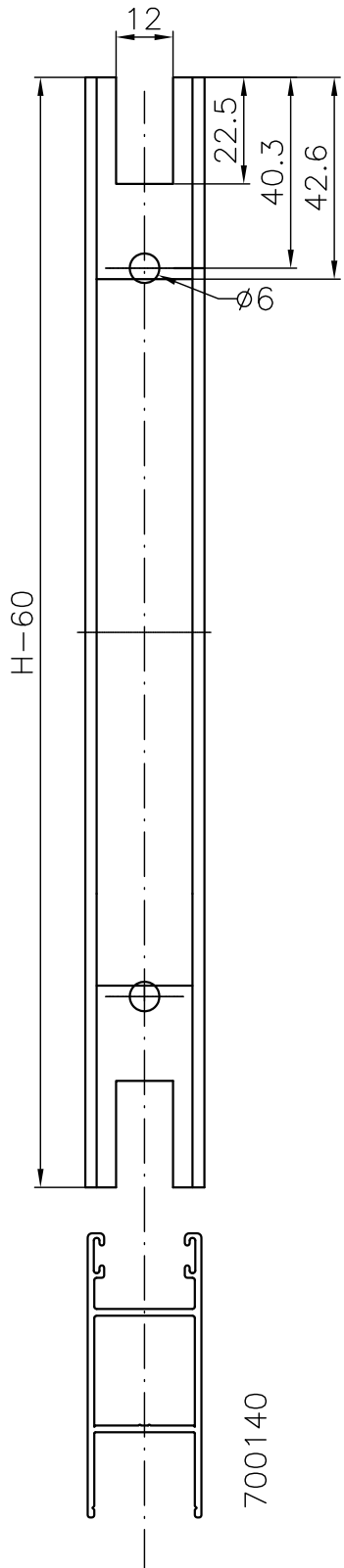

LATERAL AND CENTRAL SASH MACHINING

MECANIZADO HOJA LATERAL Y CENTRAL

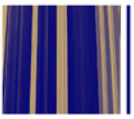

Machining - Mecanizado

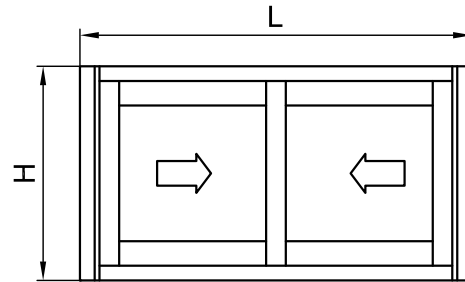

- 700060
- 700065
- 700070
- 700075
- 700401
- 700402
- 700160
- 700170
- 700063

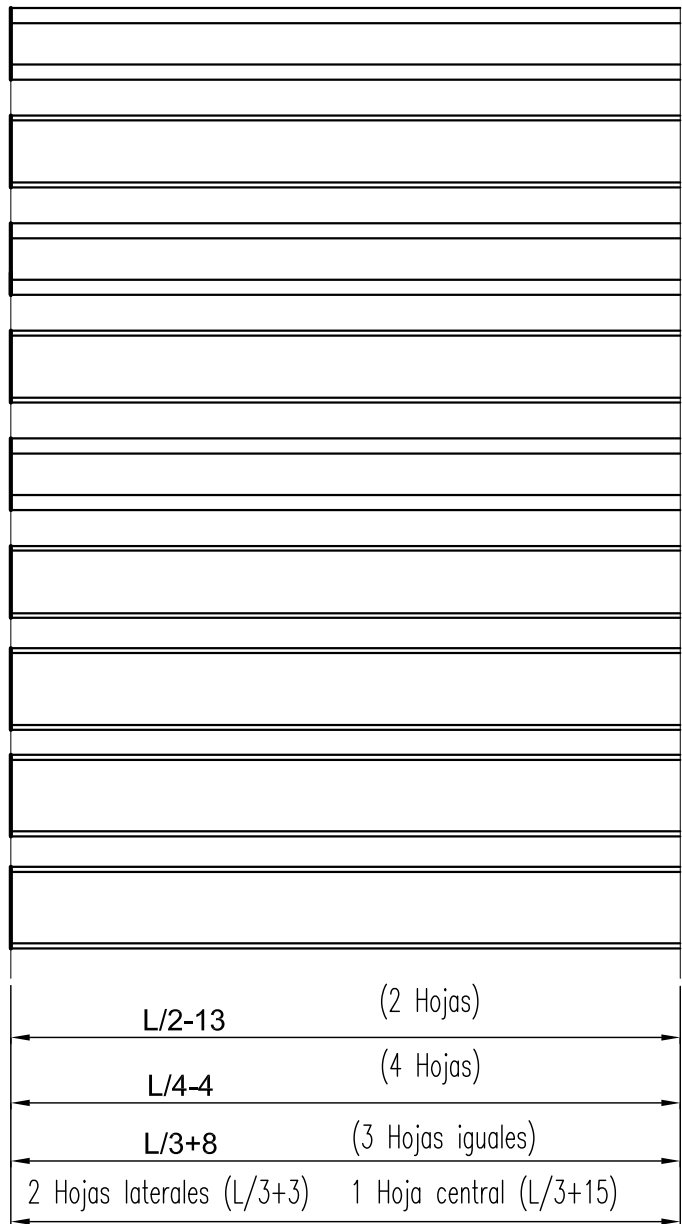

(3 Hojas mismo cristal)

HORIZONTAL SASH, SUPERIOR AND INFERIOR

HOJA HORIZONTAL, SUPERIOR E INFERIOR

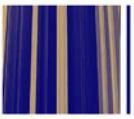

Machining - Mecanizado

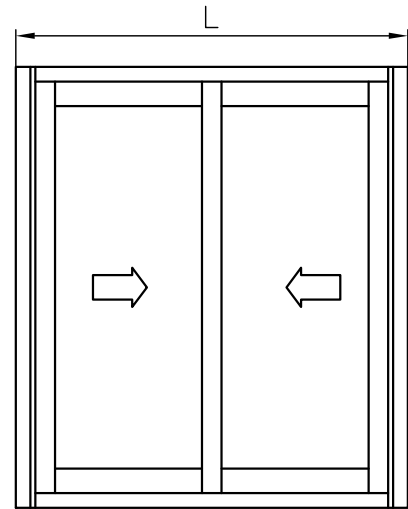
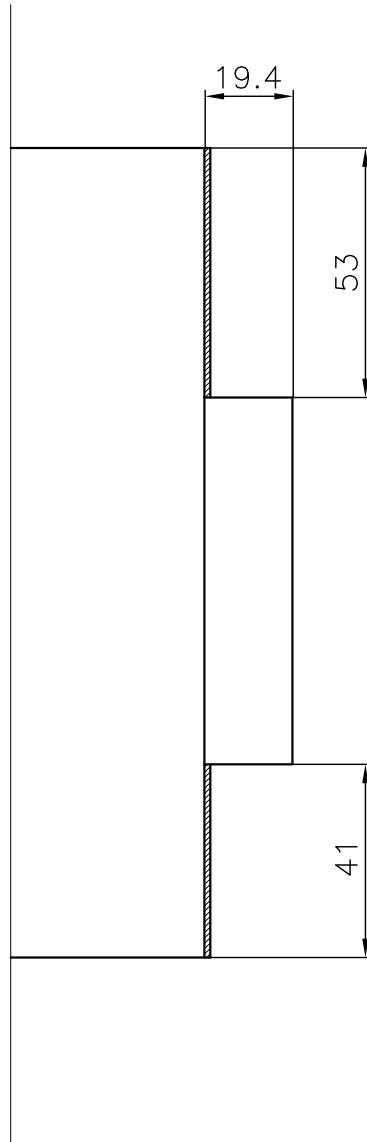
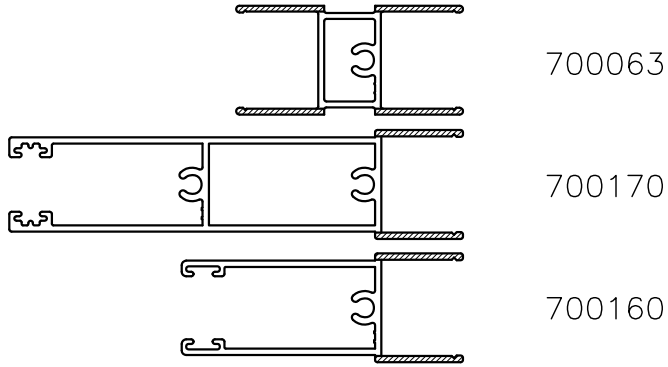

HORIZONTAL SASHES MACHINING

MECANIZADO HOJAS HORIZONTALES

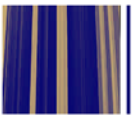

Machining - Mecanizado

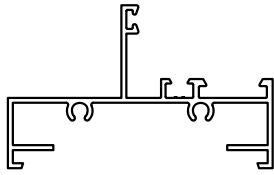

700080

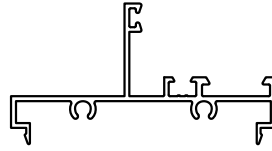

700090

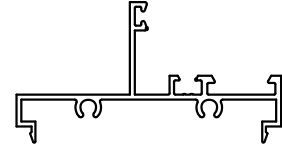
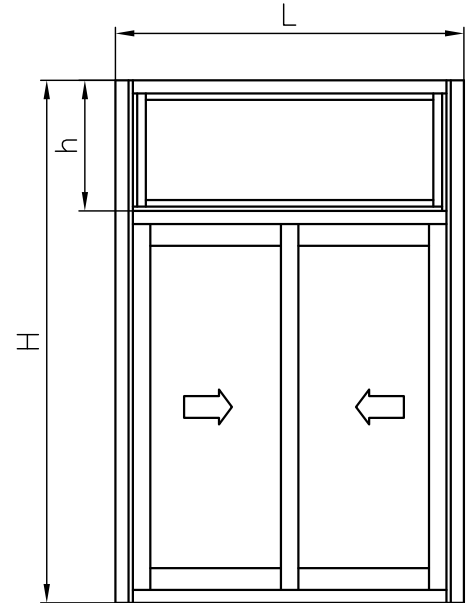
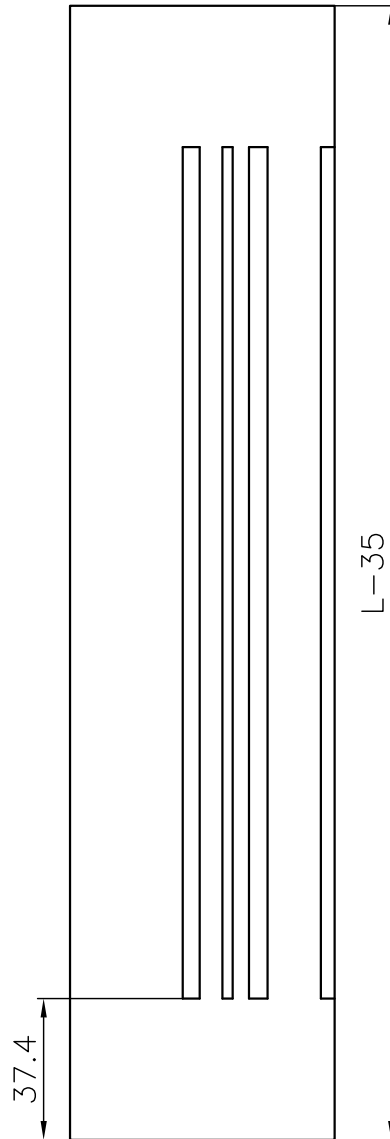
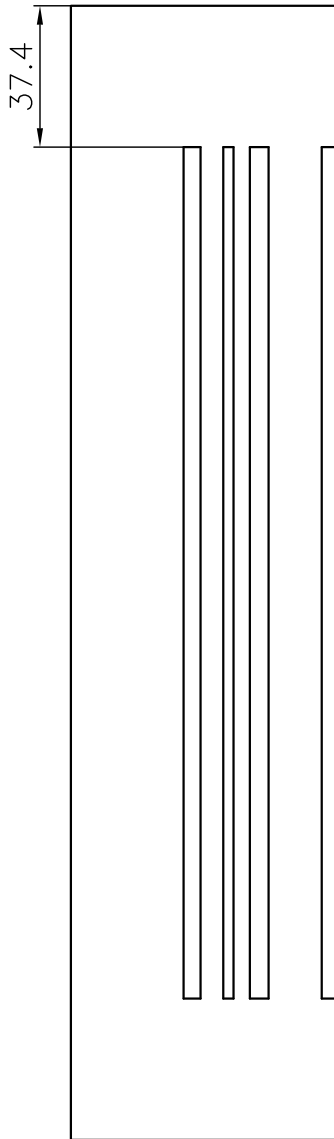

700090

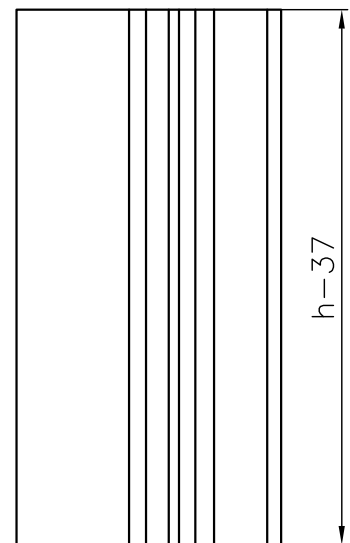

HORIZONTAL AND VERTICAL FIXED FRAME

MARCO FIJO HORIZONTAL Y VERTICAL

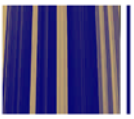

Machining - Mecanizado

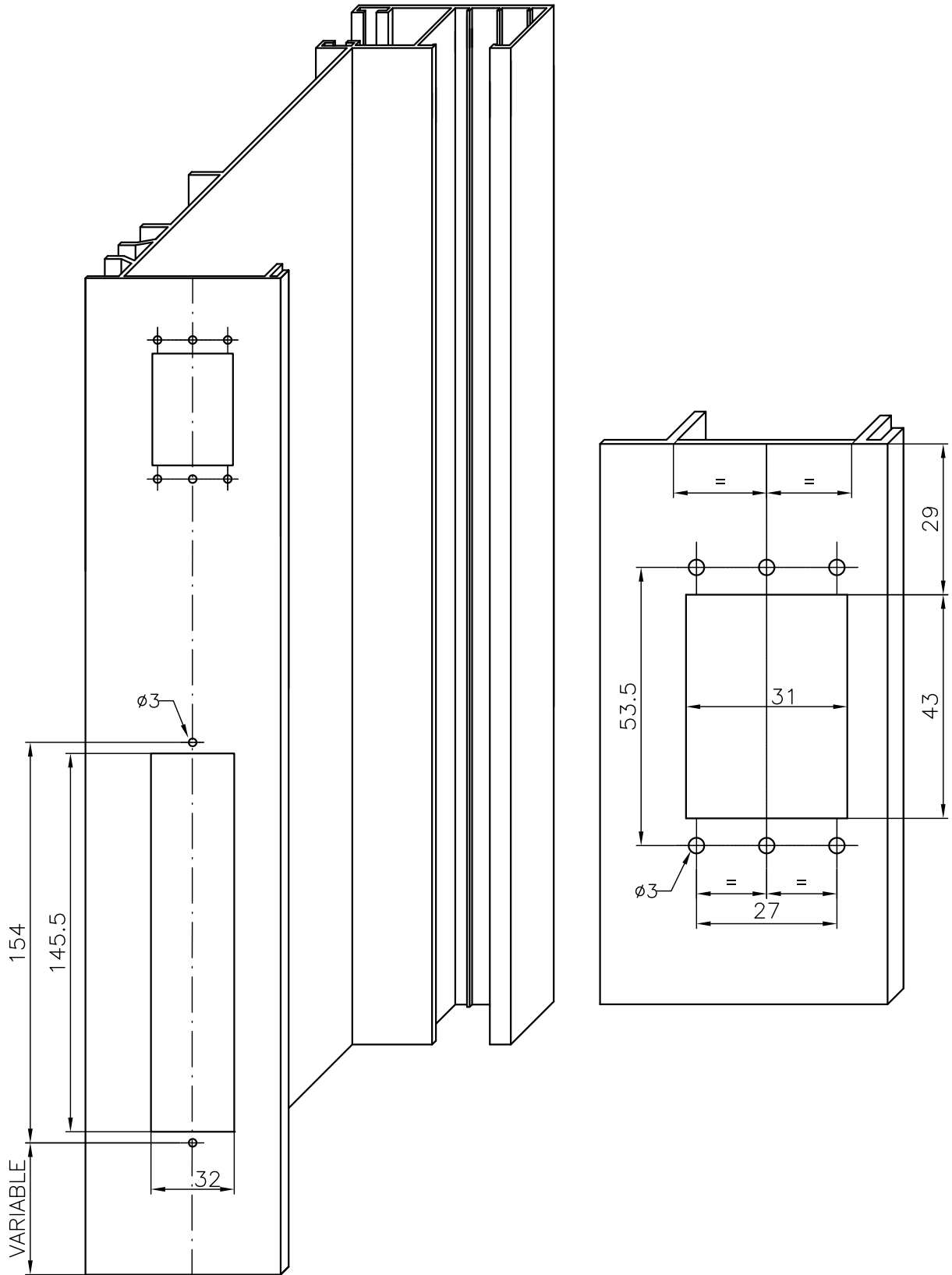

MACHINING FOR SHUTTER CASING ON LATERAL FRAME WITH GUIDE

MECANIZADO PARA EL RECOGEDOR EN MARCO LATERAL CON GUIA