



60

PRACTICABLE RPT



Serie practicable con rotura de puente térmico canal 16 para alojamiento de herrajes.
Ensamblaje con escuadras de bloqueo mecanizadas.
Poliamidas de 24 mm en marcos y 20 mm en hojas.
Anchos de marco de 54 y 59 mm y hoja de 61 y 69 mm.
Variantes estéticas con formas rectas y curvas.
Acristalamiento desde 21 a 41 mm.
Accesorios disponibles.





CANAL-16

RPT-60

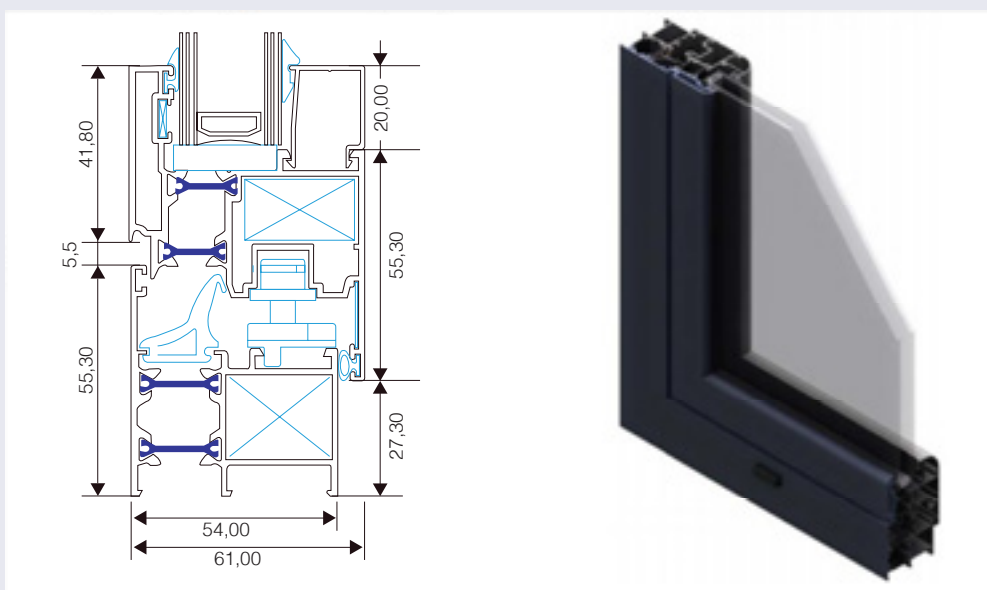

CÁLCULOS TÉRMICOS

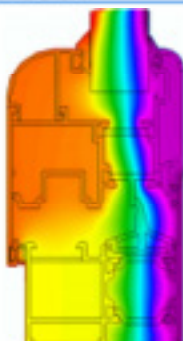

2850-2852 $U_{marco} = 3.0 \text{ W/m}^2\text{K}$

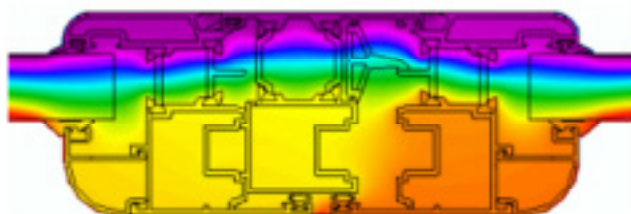

2802-2803-28002 $U_{marco} = 3.0 \text{ W/m}^2\text{K}$

RESULTADOS DE ENSAYOS

Permeabilidad al aire	CLASE 3	Permeabilidad al aire	CLASE 3
Estanqueidad al agua	CLASE E750	Estanqueidad al agua	CLASE 8A
Resistencia a la carga de viento	CLASE C5	Resistencia a la carga de viento	CLASE C3
Aislamiento acústico R_w (C;Ctr)	32 (-1,-3) dB		
Transmitancia térmica U_w	3,1 $\text{W}/(\text{m}^2\text{K})$		

Resultados de ensayo de ventana de dos hojas de 1230 (ancho) x 1480 (alto) con cajón de persiana con vidrio tipo 4-8-4.

Resultados de ensayo de puerta balconera de dos hojas de 1500 (ancho) x 2100 (alto) con cajón de persiana con vidrio tipo 4-8-4.

166010

MARCO VENTANA 45 MM CAN/16

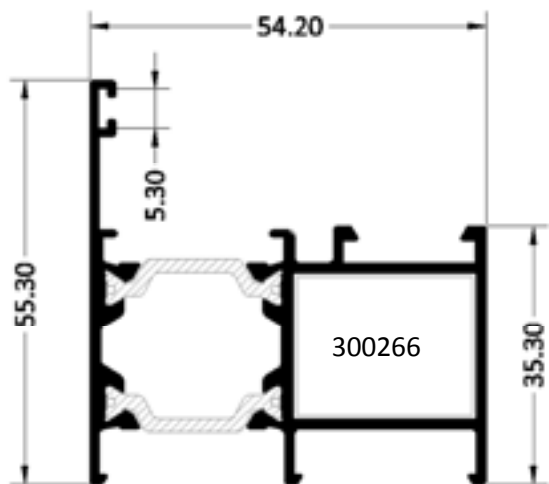

166011

MARCO VENTANA 59 MM CAN/16

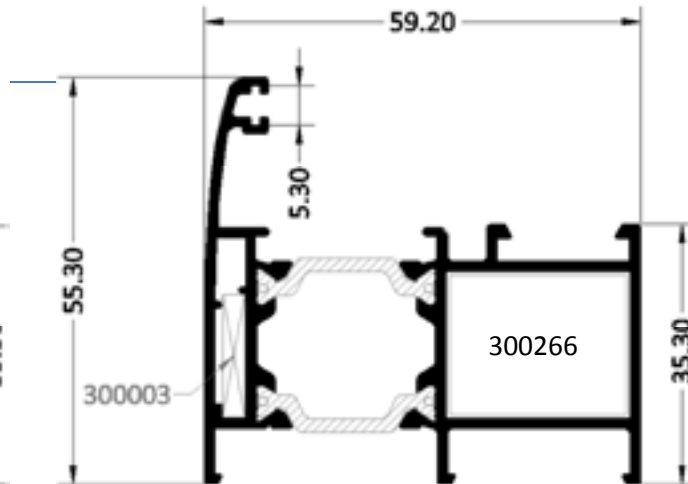

166020

HOJA VENTANA RECTA CAN/16

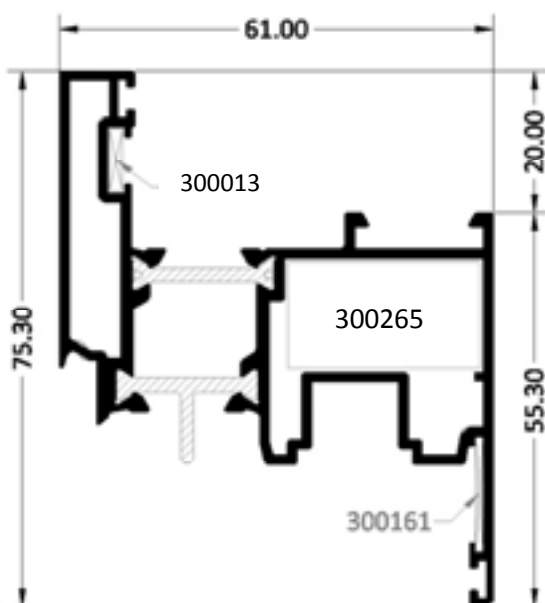

166021

HOJA PUERTA CURVA CAN/16

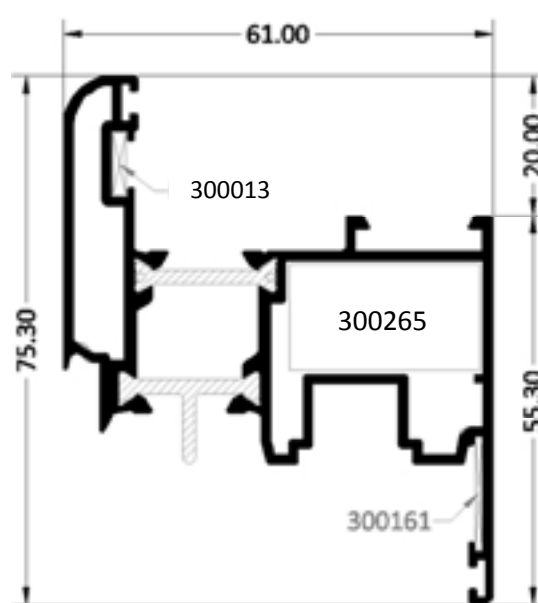

166023

HOJA PUERTA CURVA AP. EXT. CAN/16

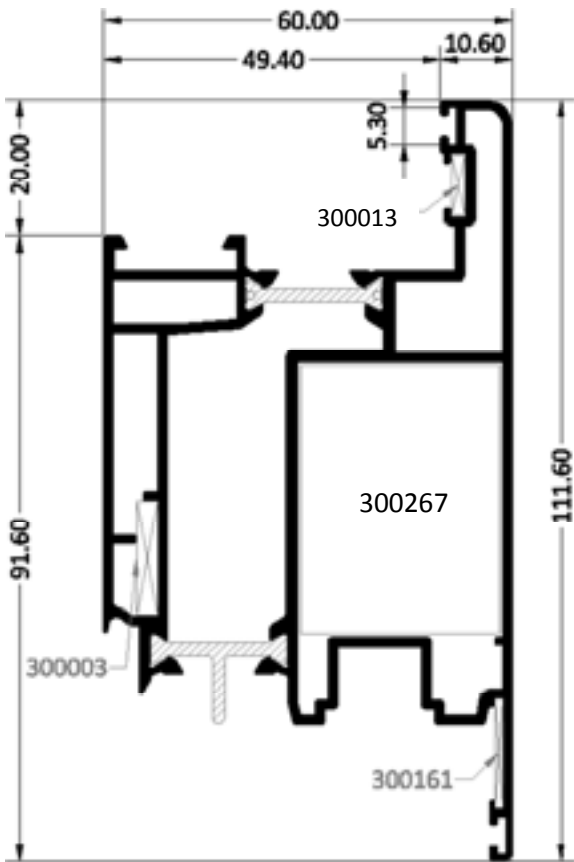

166024

HOJA PUERTA AP. INT. CAN/16

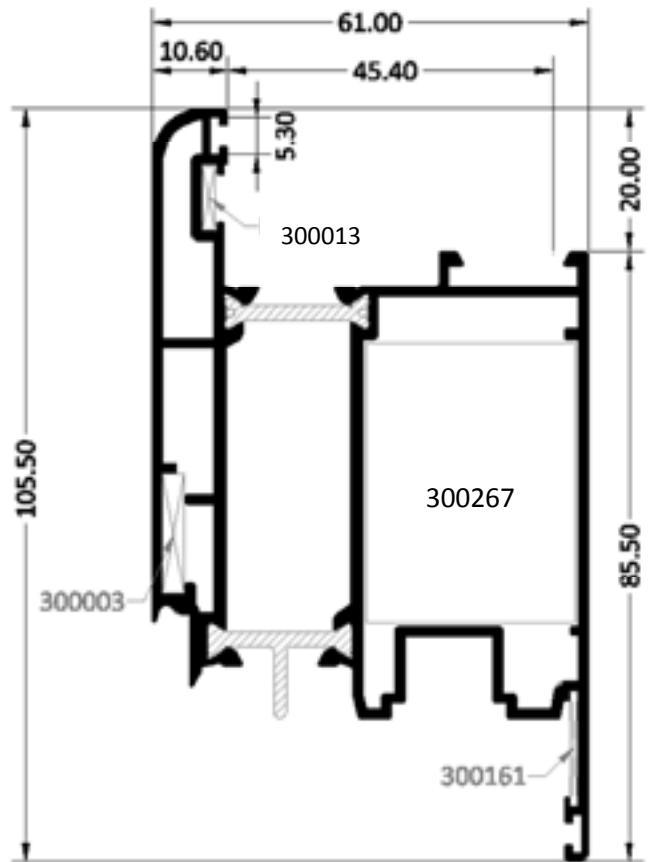

166022

HOJA PUERTA RECTA AP. INT. CAN/16

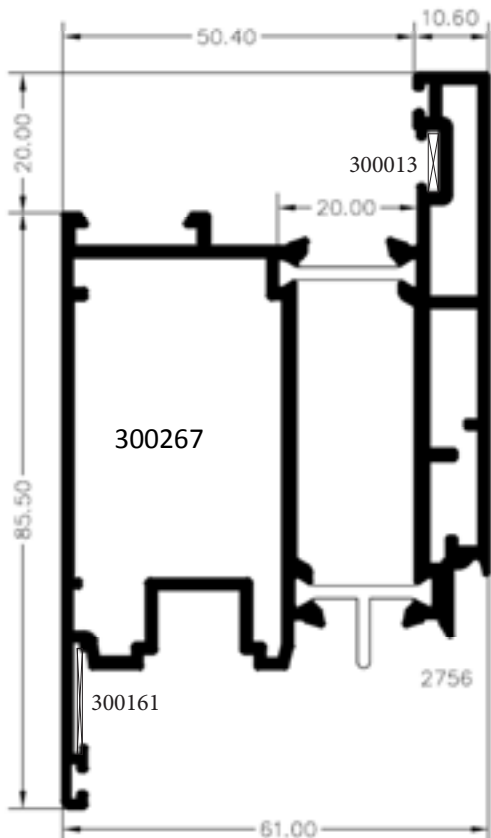

166040

INVERSOR RECTO CAN/16

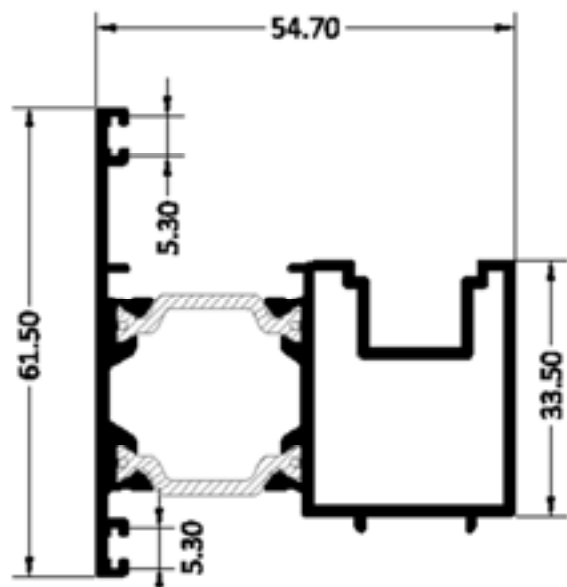

166030

TRAVESAÑO VENTANA 67 MM CAN/16

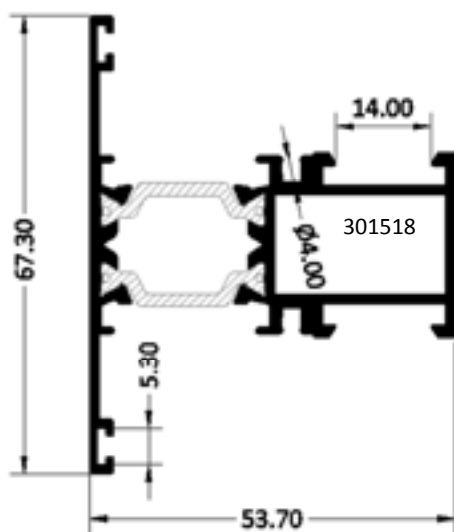

166031

TRAVESAÑO PUERTA 67 MM CAN/16

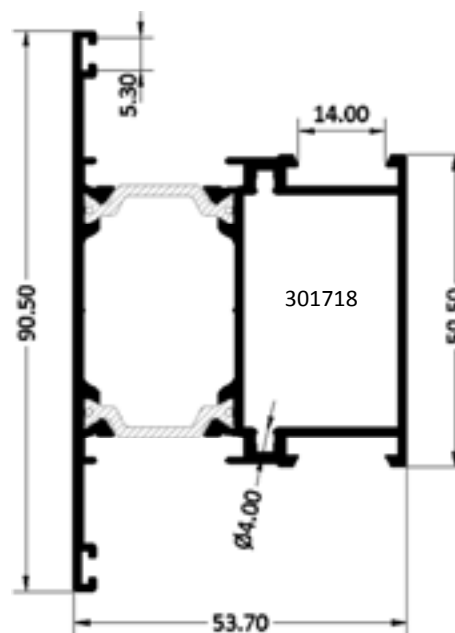

166007

ESQUINERO MARCOS 54 Y 59 MM CAN/16

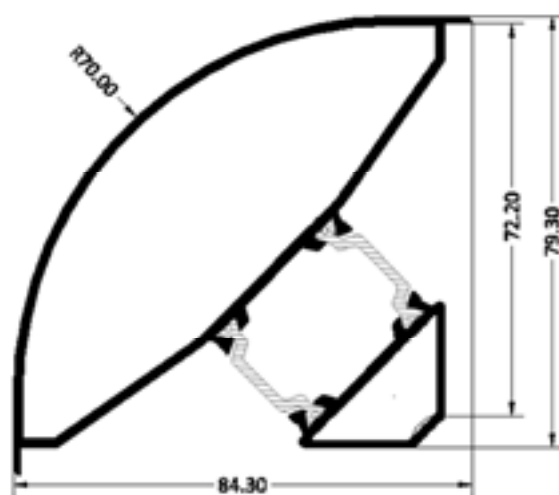

165072

SOLAPE CLIPADO DE 30 MM

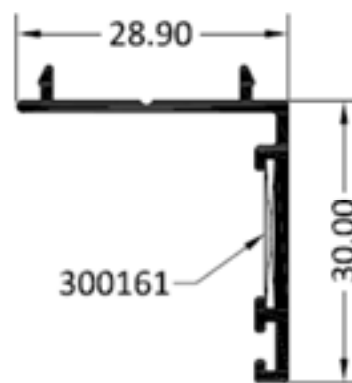

166033

PARTELUCES 140 MM CAN/16

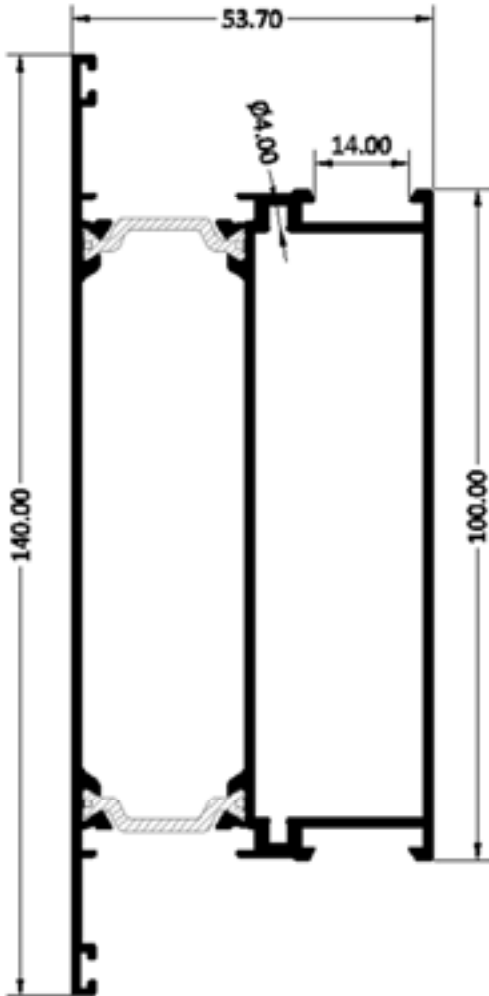

166015

ZÓCALO 140 MM CAN/16

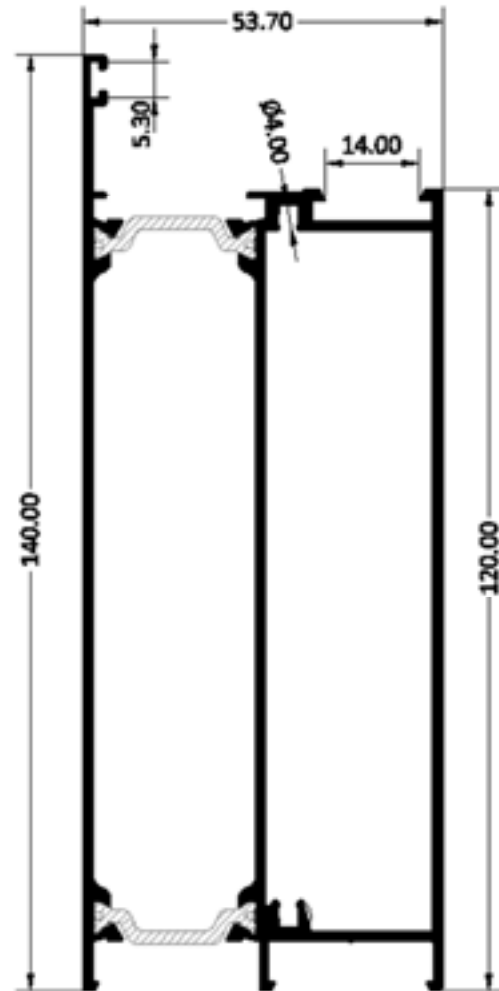

166041

UNION DE MARCOS 54 MM CAN/16

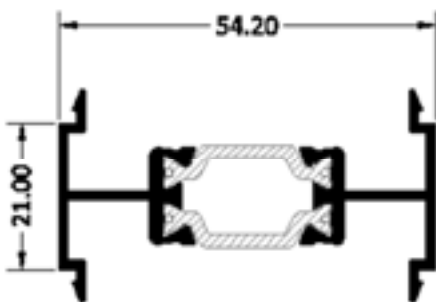

166042

UNION DE MARCOS 59 MM CAN/16

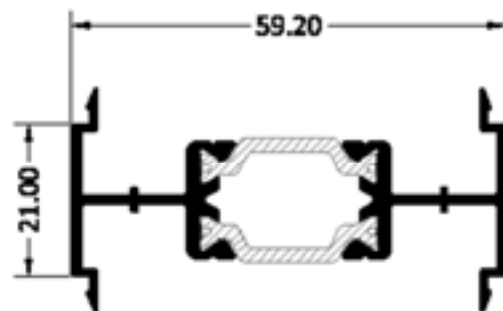

REFERENCIAS	ESQUEMA	DESCRIPCIÓN
300266		ESCUADRA MARCO VENTANA CAN/16
300265		ESCUADRA HOJA VENTANA CAN/16
300267		ESCUADRA PUERTA CAN/16
300003		ESCUADRA ALINEAMIENTO MARCO 50 CC Y 59,2 CAN/16
300161		ESCUADRA ALINEAMIENTO INTERIOR HOJA CAN/16
300013		ESCUADRA DE ALINEAMIENTO HOJAS CAMARA CAN/16
301518		UNIÓN TRAVESAÑO VENTANA
303718		UNIÓN TRAVESAÑO PUERTA
300298		JUEGO TAPAS INVERSOR PARA 166040 CAN/16
300163		TAPAS SALIDA DE AGUA CAN/16
300292		JUNTA CENTRAL MARCO 60 MM CAN/16
300280		JUNTA CIERRE MARCO CAN/16
0948076		JUNTA PERIMENTAL HOJAS CAN/16

LISTA DE CORTE - VENTANA DE UNA HOJA

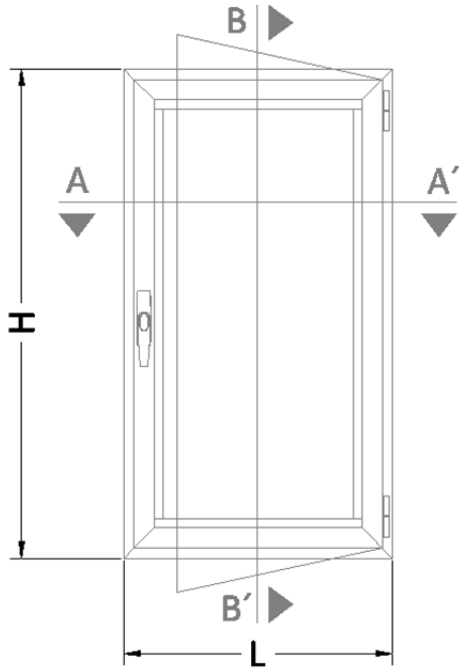

SECCION VERTICAL B-B'

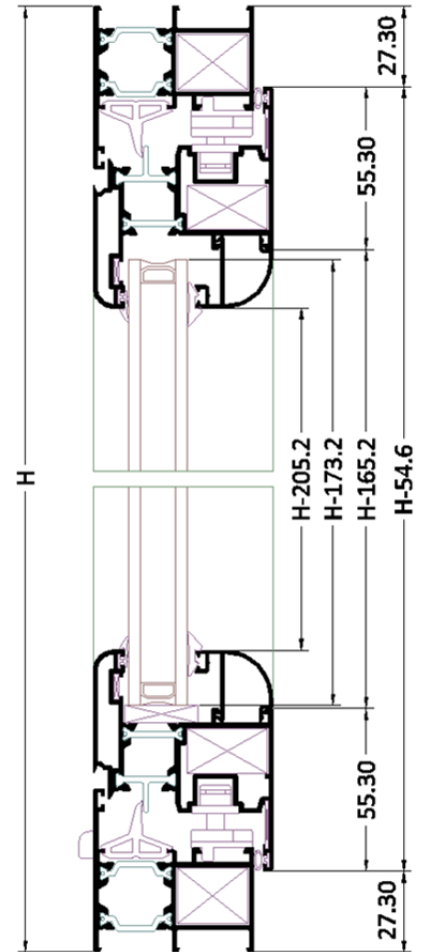

PERFIL	DESCRIPCION	UDS	CORTE
166010	MARCO VENTANA 54 MM CAN/16	2	L
166010	MARCO VENTANA 54 MM CAN/16	2	H
166021	HOJA VENTANA CURVA CAN/16	2	L-54,6
166021	HOJA VENTANA CURVA CAN/16	2	H-54,6
(*)	JUNQUILLO	2	L-165,2
(*)	JUNQUILLO	2	H-205,2

SECCION HORIZONTAL A-A'

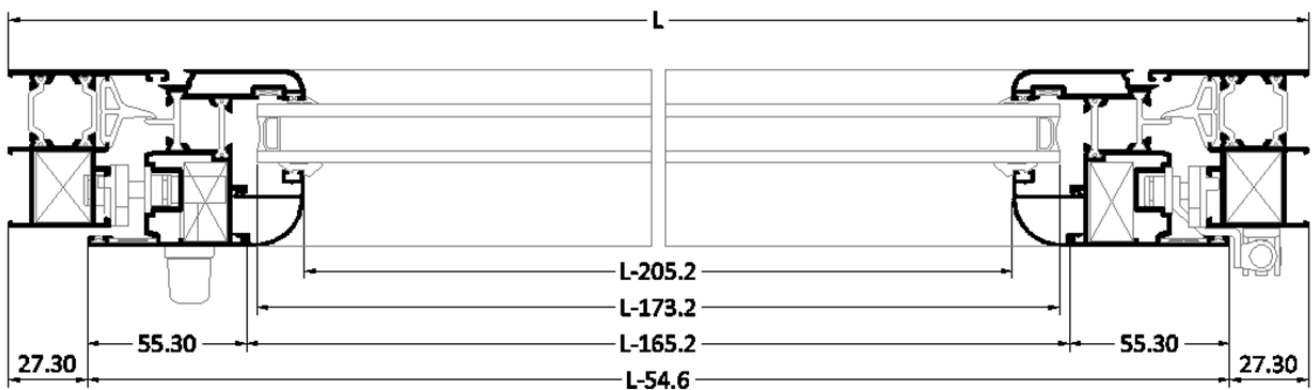

LISTA DE CORTE - VENTANA DE DOS HOJAS

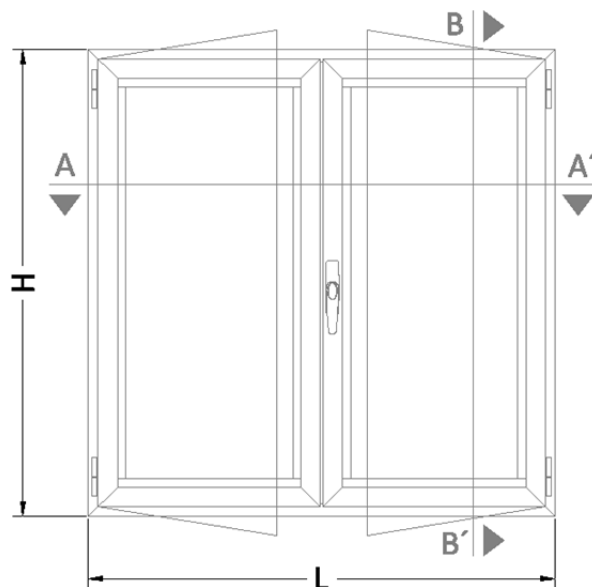

SECCION VERTICAL B-B'

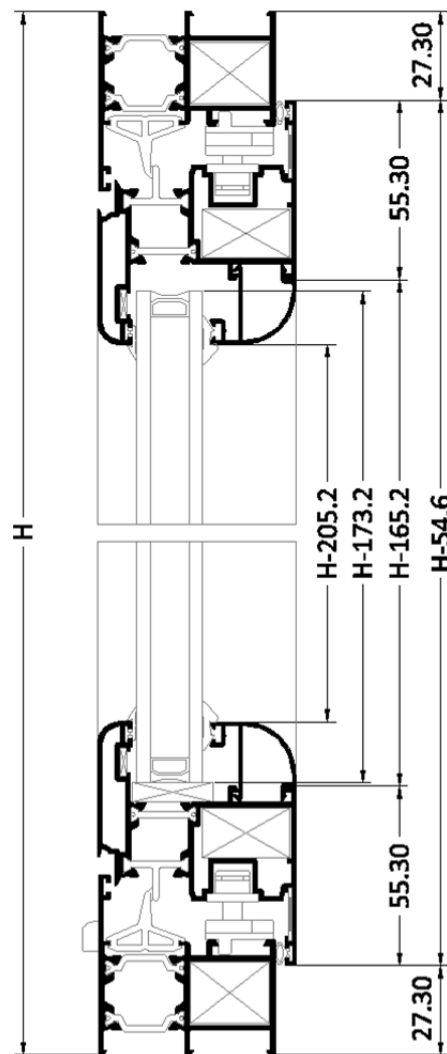

PERFIL	DESCRIPCION	UDS	CORTE
166010	MARCO VENTANA 54 MM CAN/16	2	L
166010	MARCO VENTANA 54 MM CAN/16	2	H
166021	HOJA VENTANA CURVA CAN/16	4	L/2-30,5
166021	HOJA VENTANA CURVA CAN/16	4	H-54,6
166040	INVERSOR RECTO CAN/16	1	H-134,6
(*)	JUNQUILLO	4	L/2-148,65
(*)	JUNQUILLO	4	H-205,2

SECCION HORIZONTAL A-A'

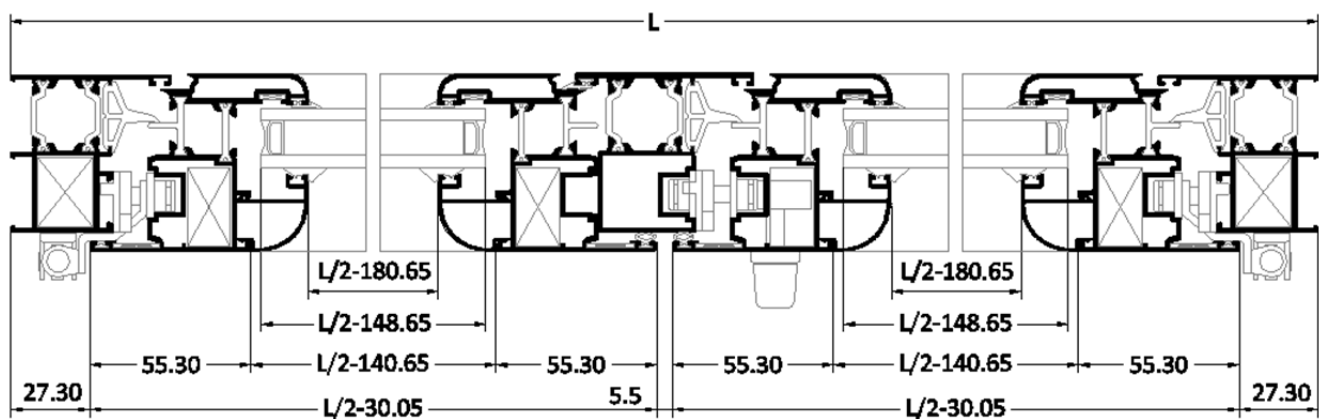

LISTA DE CORTE - VENTANA DE DOS HOJAS CON FIJO SUPERIOR

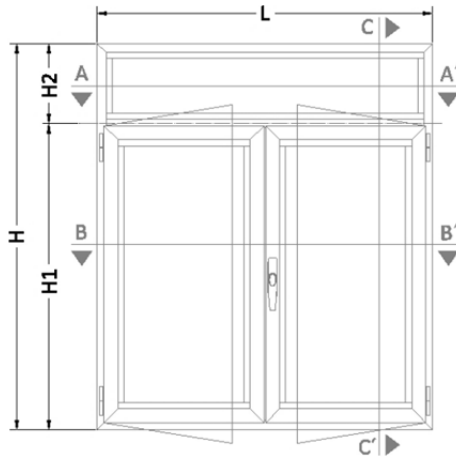

SECCION VERTICAL B-B'

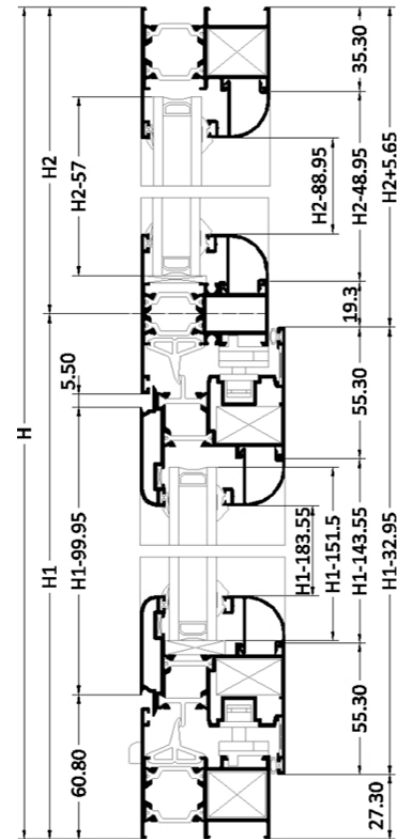

PERFIL	DESCRIPCION	UDS	CORTE
166010	MARCO VENTANA 54 MM CAN/16	2	L
166010	MARCO VENTANA 54 MM CAN/16	2	H
166030	TRAVESAÑO VENTANA 67 MM CAN/16	1	L-70,6
166021	HOJA VENTANA CURVA CAN/16	4	L/2-30,05
166021	HOJA VENTANA CURVA CAN/16	4	H1-32,95
166040	INVERSOR RECTO CAN/16	1	H1-112,95
(*)	JUNQUILLO HOJA	4	L/2-140,65
(*)	JUNQUILLO HOJA	4	H1-183,55
(*)	JUNQUILLO FIJO	2	L-70,6
(*)	JUNQUILLO FIJO	2	H2-88,95

SECCION HORIZONTAL A-A'

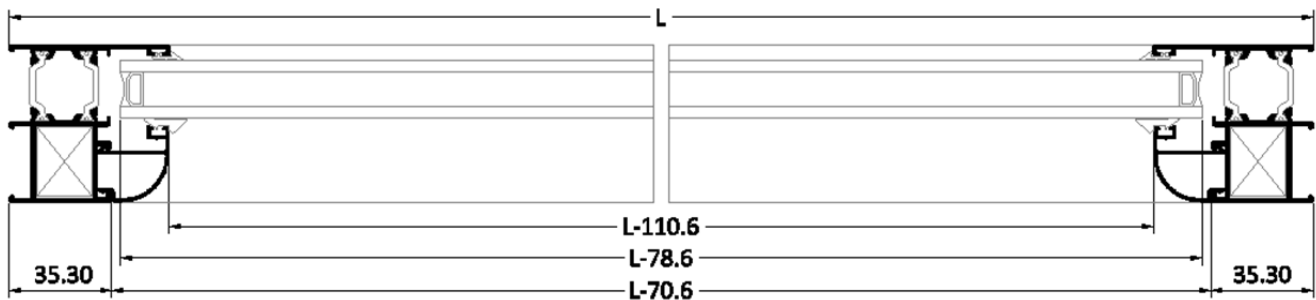

SECCION HORIZONTAL B-B'

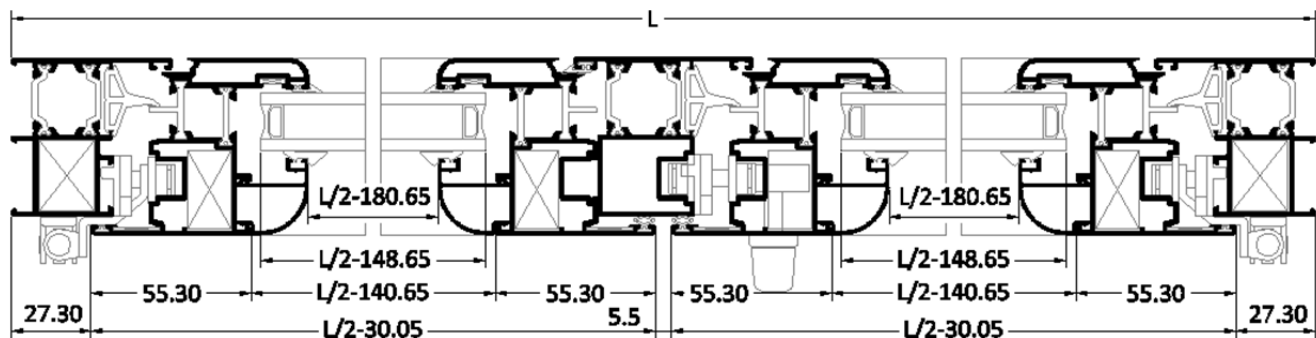

LISTA DE CORTE – BALCONERA DE DOS HOJAS APERTURA INTERIOR

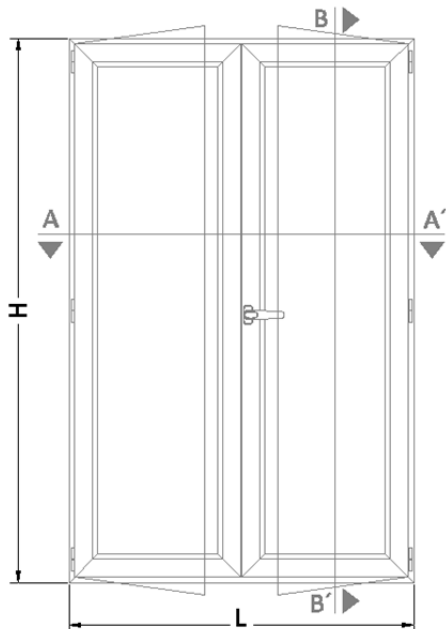

SECCION VERTICAL B-B'

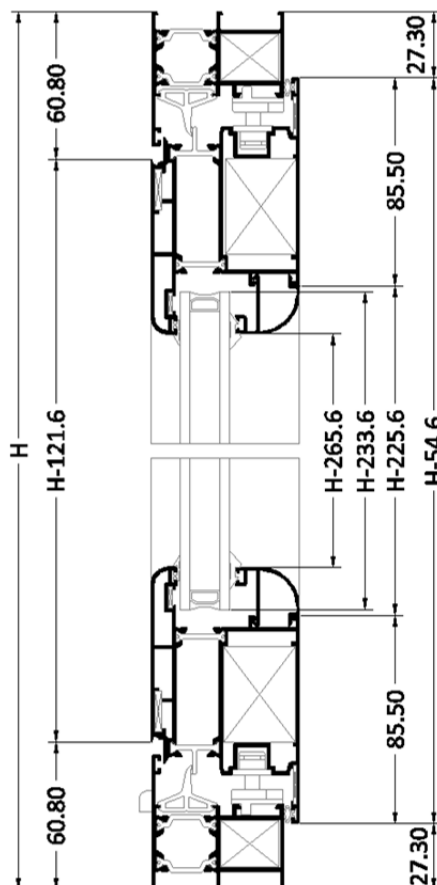

PERFIL	DESCRIPCION	UDS	CORTE
166010	MARCO VENTANA 54 MM CAN/16	2	L
166010	MARCO VENTANA 54 MM CAN/16	2	H
166022	HOJA PUERTA AP. INT. CAN/16	4	L/2-30,05
166022	HOJA PUERTA AP. INT. CAN/16	4	H-54,6
166040	INVERSOR RECTO CAN/16	1	H-121,6
(*)	JUNQUILLO HOJA	4	L/2-201,05
(*)	JUNQUILLO HOJA	4	H-265,6

SECCION HORIZONTAL A-A'

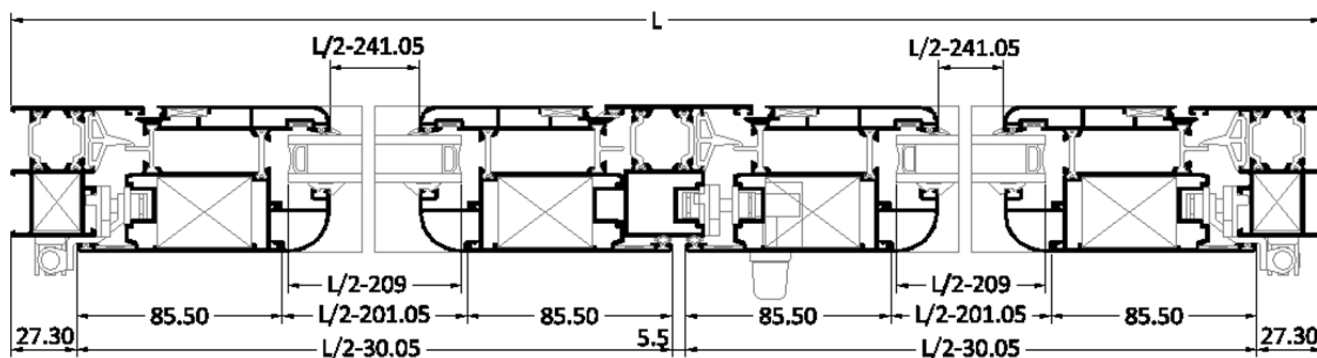

LISTA DE CORTE – PUERTA DE UNA HOJA APERTURA EXTERIOR

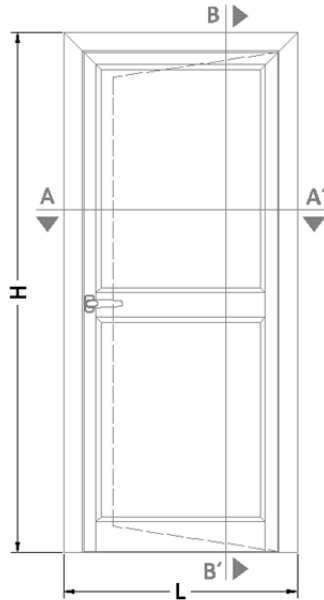

SECCION VERTICAL B-B'

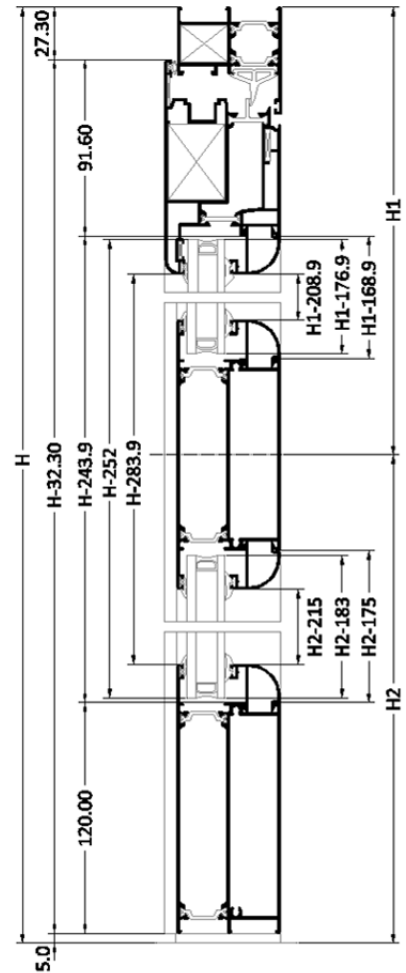

PERFIL	DESCRIPCION	UDS	CORTE
166010	MARCO VENTANA 54 MM CAN/16	1	L
166010	MARCO VENTANA 54 MM CAN/16	2	H
166023	HOJA PUERTA AP. EXT. CAN/16	1	L-54,6
166023	HOJA PUERTA AP. EXT. CAN/16	2	H-32,3
166033	PARTELUCES DE 140 MM CAN/16	1	L-237,8
166015	ZOCALO DE 140 MM CAN/16	1	L-237,8
(*)	JUNQUILLO HORIZONTAL	4	L-237,8
(*)	JUNQUILLO VERTICAL H1	2	H1-208,9
(*)	JUNQUILLO VERTIVAL H2	2	H2-215

SECCION HORIZONTAL A-A'

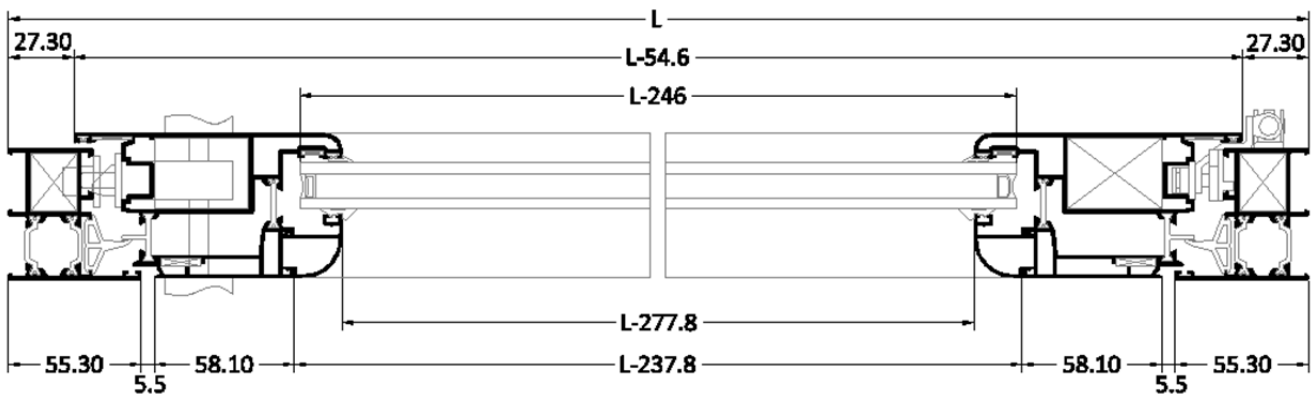

LISTA DE CORTE – PUERTA DE DOS HOJAS APERTURA EXTERIOR

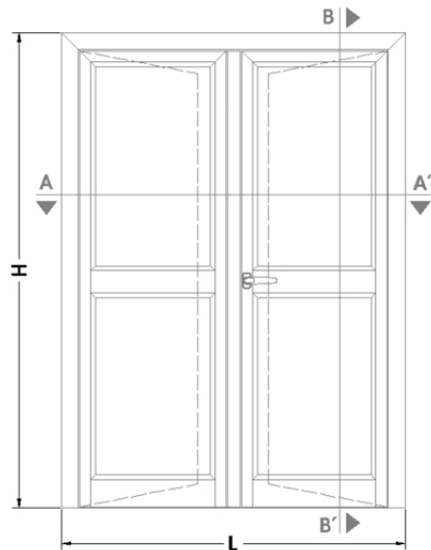

SECCION VERTICAL B-B'

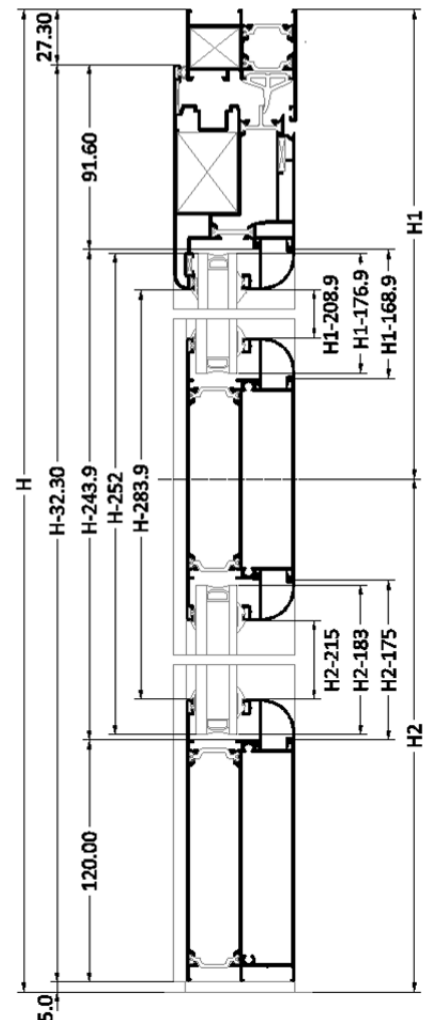

PERFIL	DESCRIPCION	UDS	CORTE
166010	MARCO VENTANA 54 MM CAN/16	1	L
166010	MARCO VENTANA 54 MM CAN/16	2	H
166023	HOJA PUERTA AP. EXT. CAN/16	2	L/2-30,05
166023	HOJA PUERTA AP. EXT. CAN/16	4	H-32,5
166040	INVERSOR RECTO CAN/16	1	H-72,3
166033	PARTELUCES DE 140 MM CAN/16	2	L/2-213,25
166015	ZOCALO DE 140 MM CAN/16	2	L/2-213,25
(*)	JUNQUILLO HORIZONTAL	8	L/2-213,25
(*)	JUNQUILLO VERTICAL H1	4	H1-208,9
(*)	JUNQUILLO VERTICAL H2	4	H2-215

SECCION HORIZONTAL A-A'

