



Sections

Secciones



Sections - *Secciones*

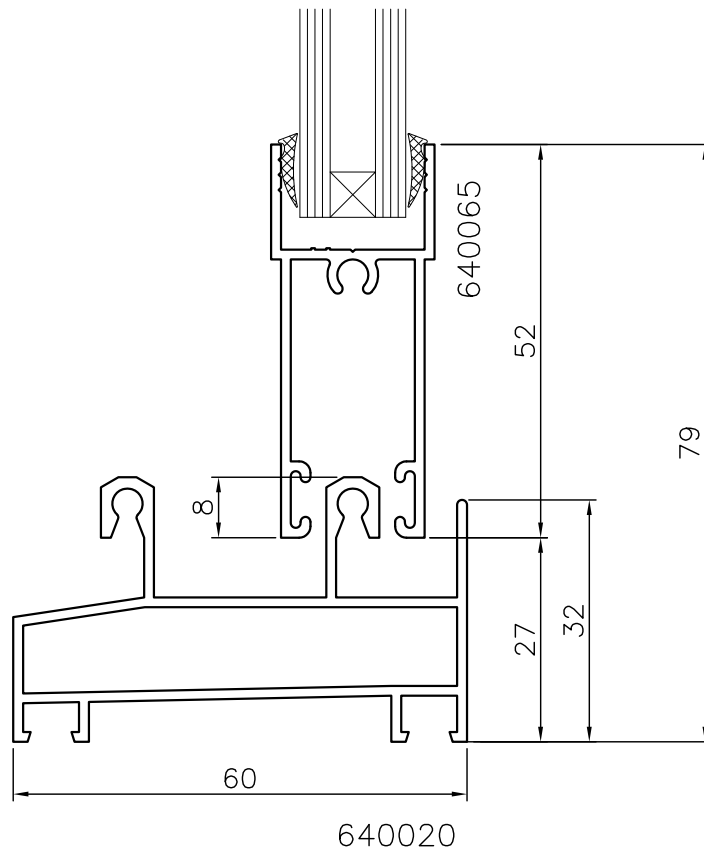

INFERIOR JOINT

NUDO INFERIOR

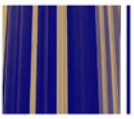

Sections - *Secciones*

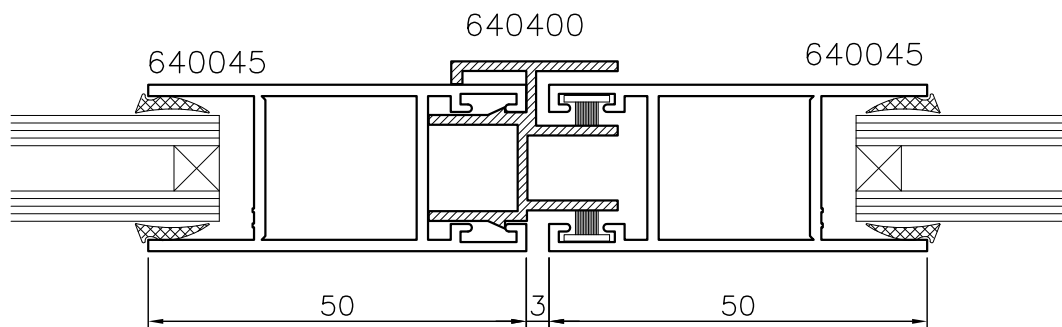

FOUR SASH JOINT

NUDO CUATRO HOJAS



Cutting schemes

Esquemas de corte



7i h]b['gWYa Yg - 7cfhY

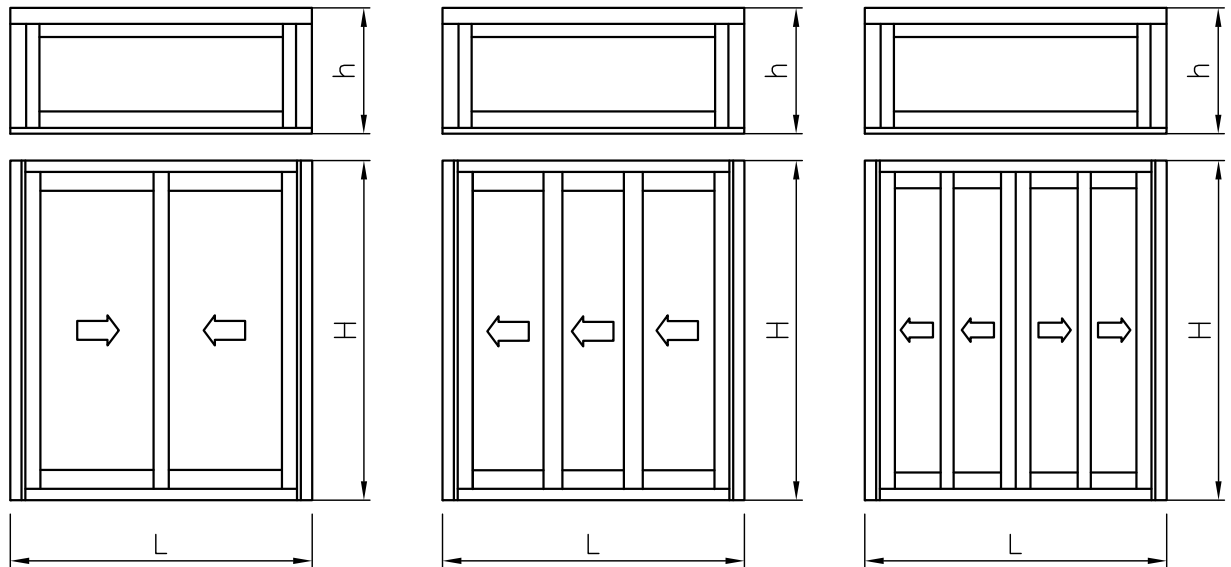

PERFILES – LONGITUDES DE CORTE								
PERFIL	FIGURA	DESCRIPCION	2 HOJAS		3 HOJAS		4 HOJAS	
			CANT.	CORTE	CANT.	CORTE	CANT.	CORTE
640010		MARCO SUPERIOR	1	L-41	1	L-41	1	L-41
640020		MARCO INFERIOR	1	L-41	1	L-41	1	L-41
640030		MARCO LATERAL	2	H	2	H	2	H
640041		HOJA LATERAL CRISTAL SENCILLO	2	H-54	2	H-54	4	H-54
640046		HOJA LATERAL CRISTAL DOBLE	2	H-54	2	H-54	4	H-54
640050		HOJA CENTRAL CRISTAL SENCILLO	2	H-54	4	H-54	4	H-54
640055		HOJA CENTRAL CRISTAL DOBLE	2	H-54	4	H-54	4	H-54
640060		HOJA DE RUEDA CRISTAL SENCILLO	4	L/2 -18	6	L/3 +4	8	L/4 -7
640065		HOJA DE RUEDA CRISTAL DOBLE	4	L/2 -18	6	L/3 +4	8	L/4 -7
640070		ZOCALO CRISTAL SENCILLO	2	L/2 -18	3	L/3 +4	4	L/4 -7
640075		ZOCALO CRISTAL DOBLE	2	L/2 -18	3	L/3 +4	4	L/4 -7
640080		MARCO FIJO SIN CLIP	2	h-32	2	h-32	2	h-32
640080		MARCO FIJO SIN CLIP	1	L	1	L	1	L
640090		MARCO FIJO CON CLIP	1	L	1	L	1	L
VARIOS		JUNQUILLO	2	L-41	2	L-41	2	L-41
VARIOS		JUNQUILLO	2	h-68	2	h-68	2	h-68
230401		DIVISOR CRISTAL SIMPLE	2	L/2 -18	3	L/3 +4	4	L/4 -7
230402		DIVISOR CRISTAL DOBLE	2	L/2 -18	3	L/3 +4	4	L/4 -7
640400		PERFIL 4 HOJAS					1	H-54

UWO WAYS CUTTING WITH FIXED INDEPENDENT

Coku-) -) \ o#° kk@o#\ V 7@ () -h-V) @Vu-

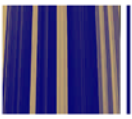

7i h]b['gWYa Yg - 7cfhY

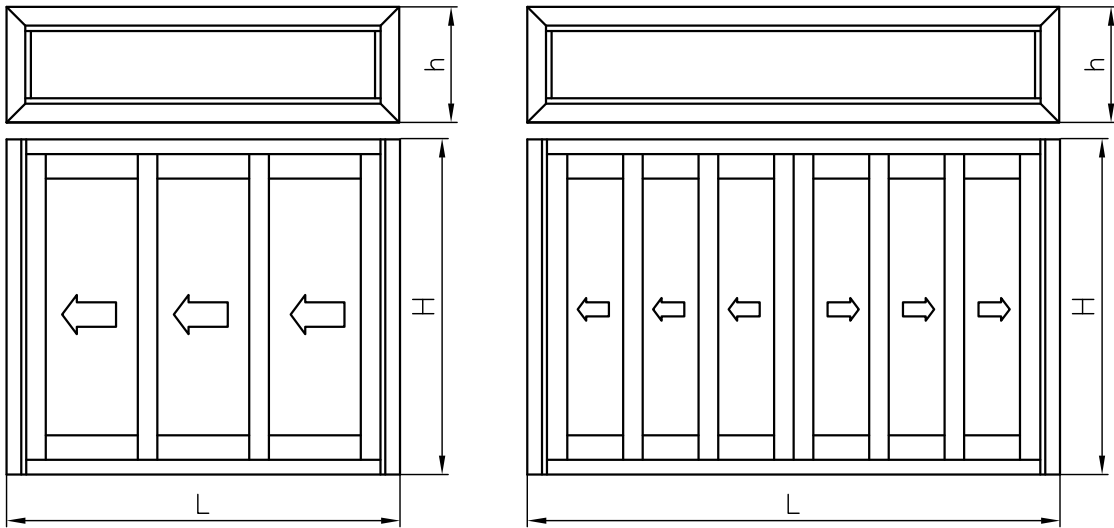

PERFILES - LONGITUDES DE CORTE						
PERFIL	FIGURA	DESCRIPCION	3 HOJAS		6 HOJAS	
			CANT.	CORTE	CANT.	CORTE
640040		HOJA LATERAL CRISTAL SENCILLO	2	H-54	4	H-54
640045		HOJA LATERAL CRISTAL DOBLE	2	H-54	4	H-54
640050		HOJA CENTRAL CRISTAL SENCILLO	4	H-54	8	H-54
640055		HOJA CENTRAL CRISTAL DOBLE	4	H-54	8	H-54
640060		HOJA DE RUEDA CRISTAL SENCILLO	6	L/3 +2	12	L/6 +8
640065		HOJA DE RUEDA CRISTAL DOBLE	6	L/3 +2	12	L/6 +8
640070		ZOCALO CRISTAL SENCILLO	3	L/3 +2	6	L/6 +8
640075		ZOCALO CRISTAL DOBLE	3	L/3 +2	6	L/6 +8
230310		MARCO SUPERIOR TRES CARRILES	1	L-31	1	L-31
230320		MARCO INFERIOR TRES CARRILES	1	L-31	1	L-31
230330		MARCO LATERAL TRES CARRILES	2	H	2	H
10080		MARCO FIJO	2	L	2	L
10080		MARCO FIJO	2	h	2	h
VARIOS		JUNQUILLO	2	L-52	2	L-52
VARIOS		JUNQUILLO	2	h-91	2	h-91
230401		DIVISOR CRISTAL SIMPLE	3	L/3 +2	6	L/6 +8
230402		DIVISOR CRISTAL DOBLE	3	L/3 +2	6	L/6 +8
640400		PERFIL 4 HOJAS			1	H-54

THREE WAYS CUTTING WITH LATERAL SASHES OF 50 AND CENTRALS OF 45

COKu) - uk-o#° kk@o#\ V= \K oO u-k° Qo) - ' " O o#-Vuk° Qo) -

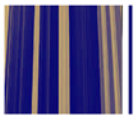

7i h]b['gWYa Yg - 7cfhY

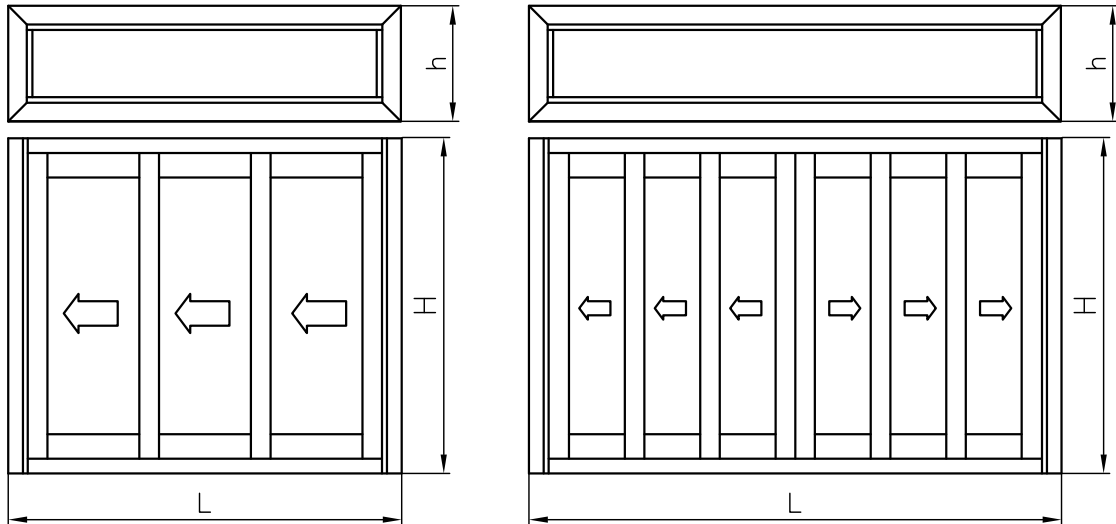

PERFILES – LONGITUDES DE CORTE						
PERFIL	FIGURA	DESCRIPCION	3 HOJAS		6 HOJAS	
			CANT.	CORTE	CANT.	CORTE
640041		HOJA LATERAL 55 CRISTAL SENCILLO	2	H-54	4	H-54
640046		HOJA LATERAL 55 CRISTAL DOBLE	2	H-54	4	H-54
640051		HOJA CENTRAL 50 CRISTAL SENCILLO	4	H-54	8	H-54
640056		HOJA CENTRAL 50 CRISTAL DOBLE	4	H-54	8	H-54
640060		HOJA DE RUEDA CRISTAL SENCILLO	6	L/3 +6	12	L/6 +12
640065		HOJA DE RUEDA CRISTAL DOBLE	6	L/3 +6	12	L/6 +12
640070		ZOCALO CRISTAL SENCILLO	3	L/3 +6	6	L/6 +12
640075		ZOCALO CRISTAL DOBLE	3	L/3 +6	6	L/6 +12
230310		MARCO SUPERIOR TRES CARRILES	1	L-31	1	L-31
230320		MARCO INFERIOR TRES CARRILES	1	L-31	1	L-31
230330		MARCO LATERAL TRES CARRILES	2	H	2	H
10080		MARCO FIJO	2	L	2	L
10080		MARCO FIJO	2	h	2	h
VARIOS		JUNQUILLO	2	L-52	2	L-52
VARIOS		JUNQUILLO	2	h-91	2	h-91
230401		DIVISOR CRISTAL SIMPLE	3	L/3 +6	6	L/6 +12
230402		DIVISOR CRISTAL DOBLE	3	L/3 +6	6	L/6 +12
640400		PERFIL 4 HOJAS			1	H-54

THREE WAYS CUTTING WITH LATERAL SASHES OF 55 AND CENTRALS OF 50

COKu #\ V'uk-o#° kk@o#\ V°=\ K oO u-k° Qo) - ' " O o#\ Vuk° Qo) -