

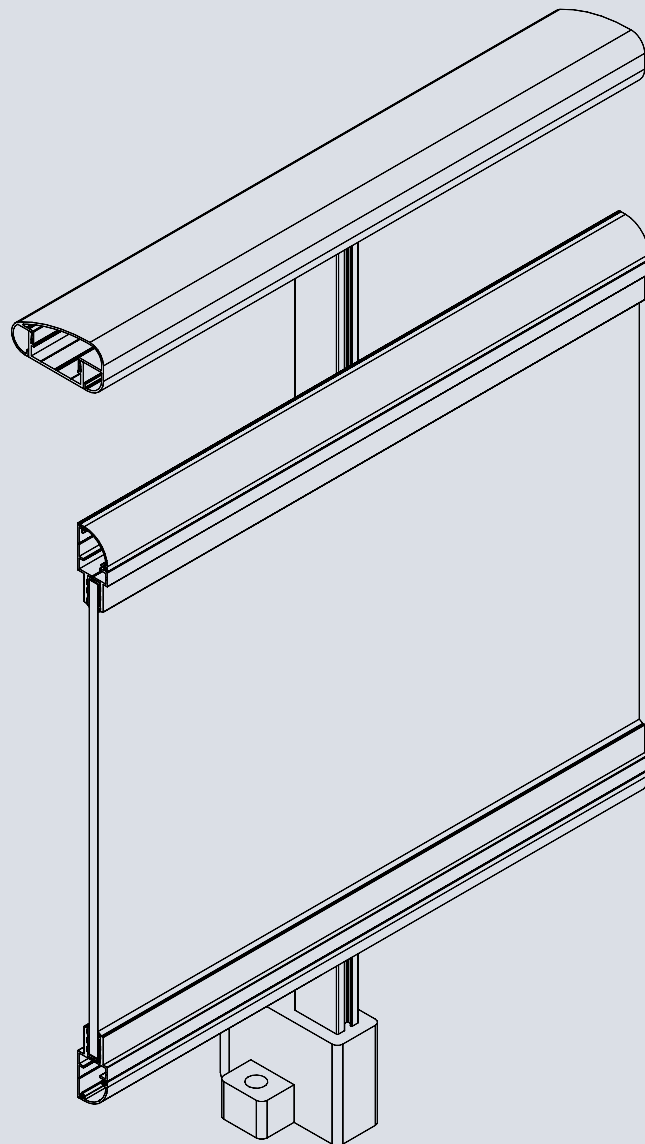

# Cutting schemes

## *Esquemas de corte*

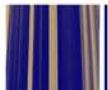



7i m]b[ 'gV\Ya Yg - 7cfhY

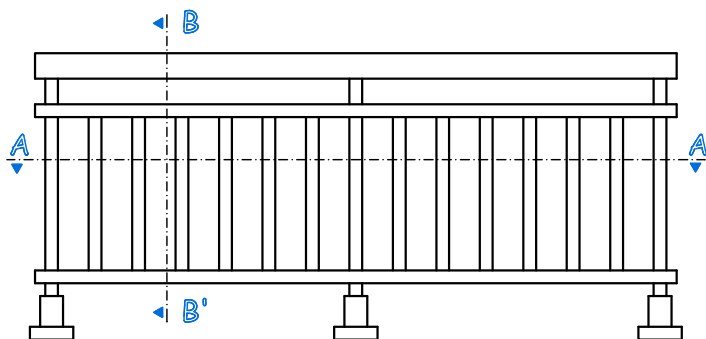
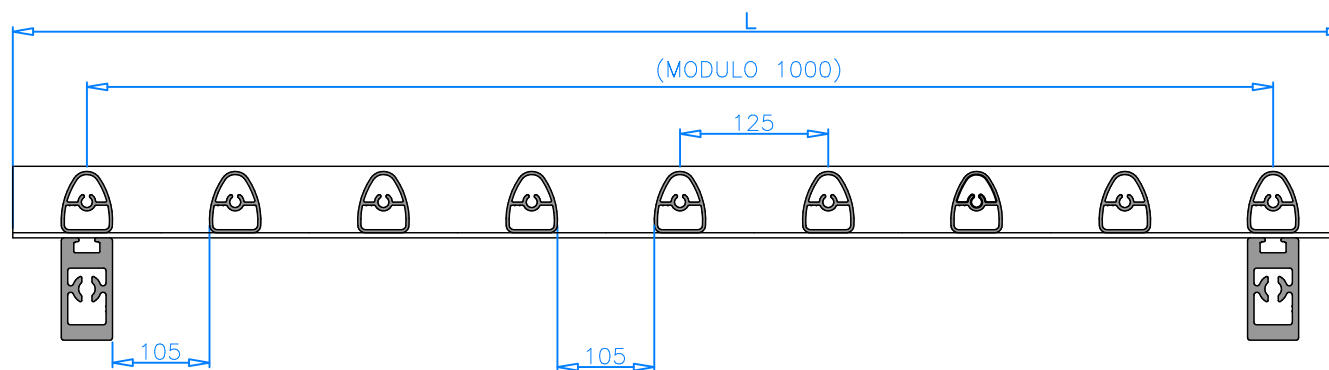
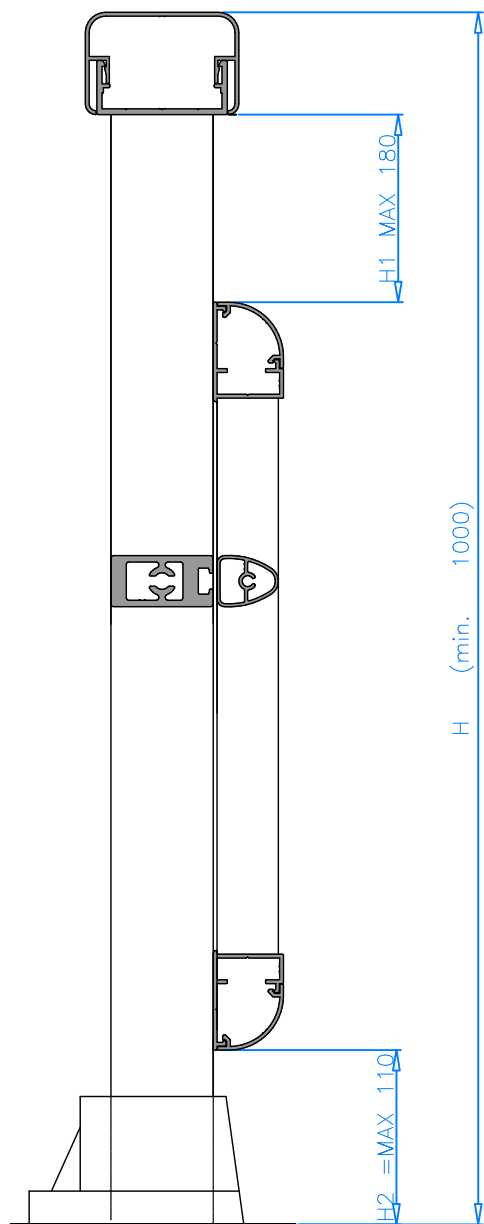







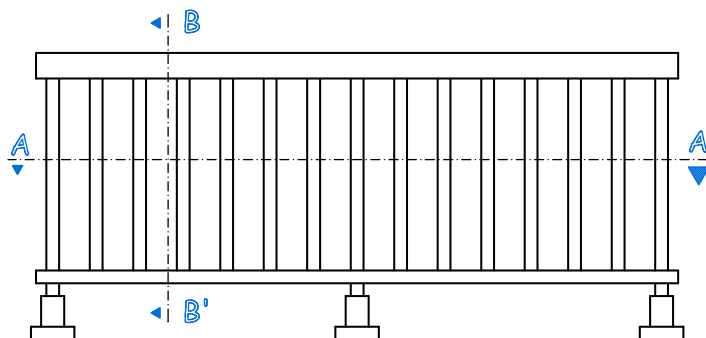
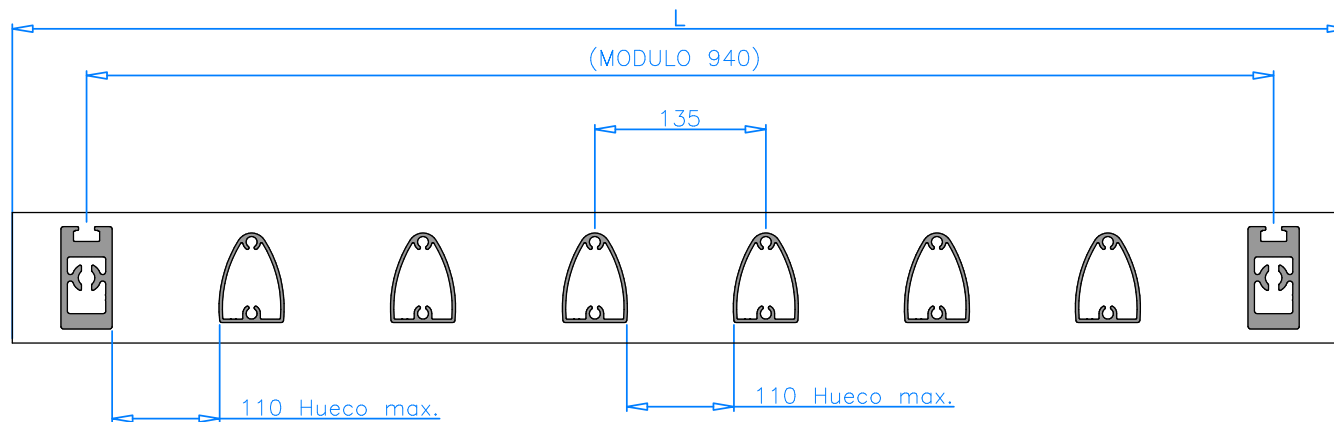
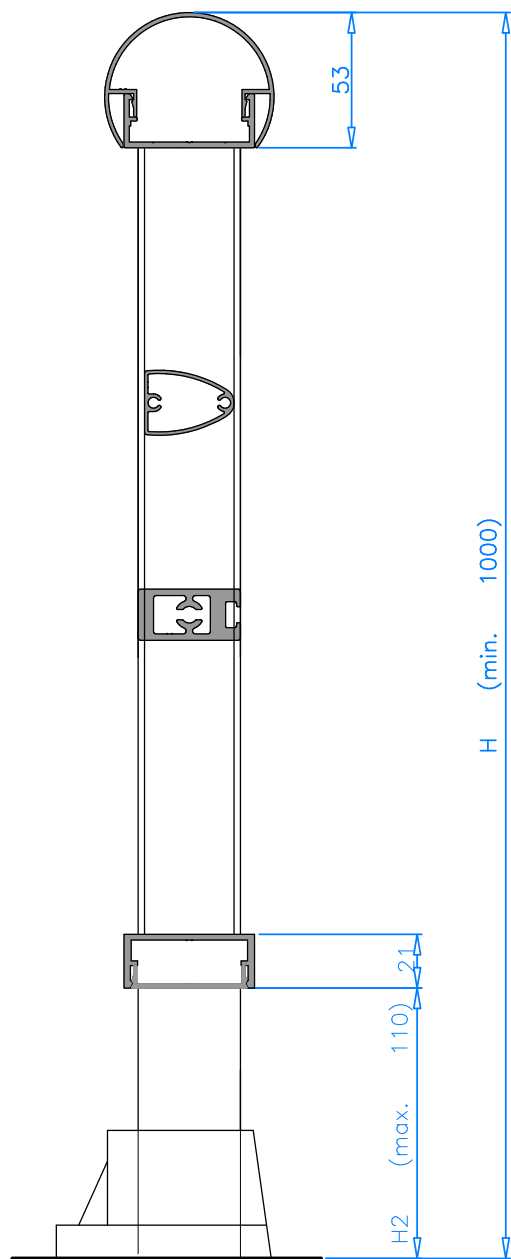







### DESGLOSE DE MATERIALES

PERFIL	CODIGO	DENOMINACION	CORTE	Nº PIEZAS	MEDIDA
	50013	PASAMANOS		1	L
	50018	ANCLAJE PASAMANOS		1	L
	50050	PORTABARROTILLO		2	L
	50052	TAPA		2	L
	50030	PILAR		$\frac{L}{1000} + 1$	H-40
	50060	BARROTILLO		$\frac{8 \times L}{1000}$	H-H1-H2-100
	5070461	ANCLAJE PAVIMENTO		IGUAL Nº PILASTRAS	
	5079886	TAPA PORTABARROTILLOS DERECHA		Nº DE BARRAS 50050	
	5079887	TAPA PORTABARROTILLOS IZQUIERDA		Nº DE BARRAS 50050	
	5070382	TORNILLO, TUERCA Y ARANDELA M6 INOX		2 X (Nº PILAR)	
	5070450	TAPA PASAMANO		2	
	5070041	JUNTA RANURA PILAR		Nº PILAR	H-40
		TORNILLO INOXIDABLE		2 X (Nº 50060)	4.8x32
		TORNILLO INOXIDABLE		Nº PILAR	M8x30

7i h]b[ 'gV\Ya Yg - 7cfhY



### DESGLOSE DE MATERIALES

PERFIL	CODIGO	DENOMINACION	CORTE	N° PIEZAS	MEDIDA
	50015	PASAMANOS		1	L
	50020	TAPA		1	L
	50018	ANCLAJE PASAMANOS		2	L
	50061	BARROTE		$\frac{6 \times L}{940}$	H-H2-74
	50030	PILAR		$\frac{L}{940} + 1$	H-53
	5070461	ANCLAJE PAVIMENTO		IGUAL N°	PILASTRAS
	5070723	TAPA PASAMANO		2	
	5070041	JUNTA RANURA PILAR		N° PILAR	H-53
		TORNILLO INOXIDABLE		4 X (N° 50061)	4.8x32
		TORNILLO INOXIDABLE		N° PILAR	M8x30

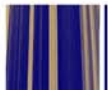

7i m]b[ 'gV\Ya Yg - 7cfhY

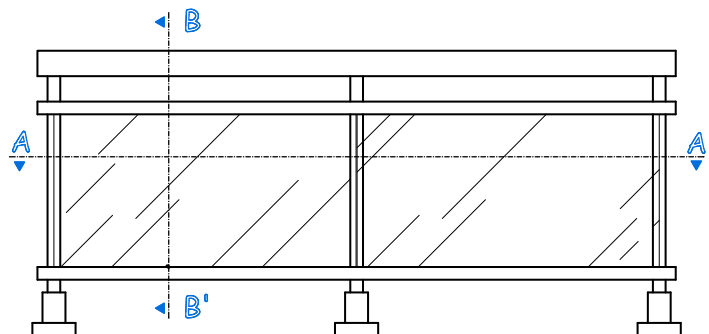
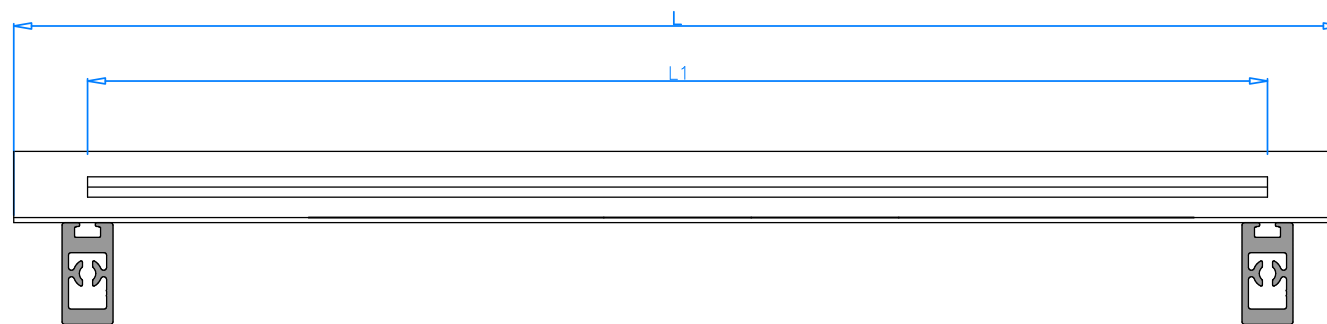
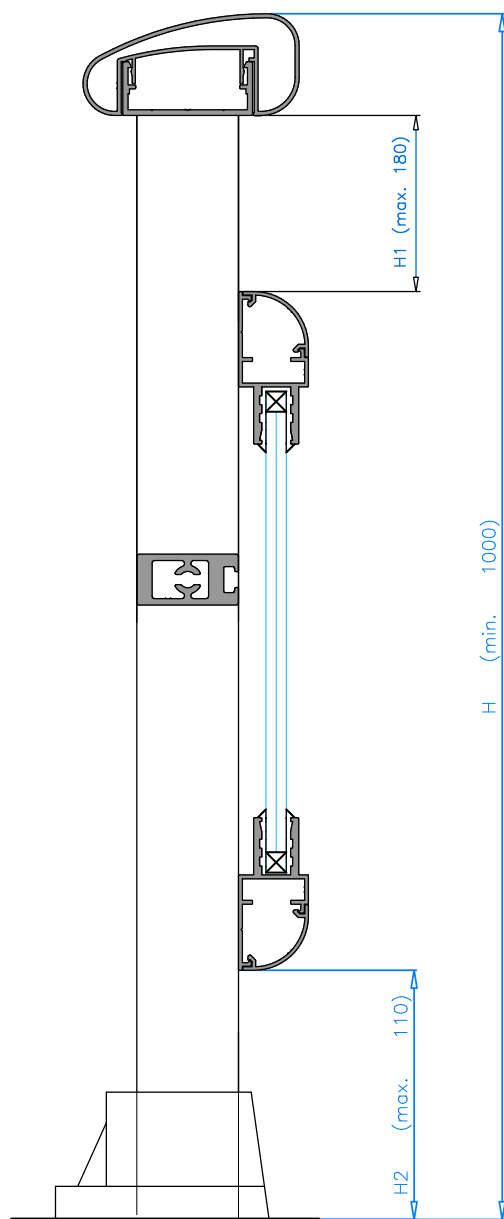

### DESGLOSE DE MATERIALES

PERFIL	CODIGO	DENOMINACION	CORTE	N° PIEZAS	MEDIDA
	50016	PASAMANOS		1	L
	50018	ANCLAJE PASAMANOS		1	L
	50051	PORTACRISTAL		2	L
	50052	TAPA		2	L
	50030	PILAR		L/L1 + 1	H-40
	5070046	JUNTA VIDRIO		2	L
	5070461	ANCLAJE PAVIMENTO		N° DE PILAR	
	5079886	TAPA PORTACRISTAL DERECHA		N° BARRAS 50051	
	5079887	TAPA PORTACRISTAL IZQUIERDA		N° BARRAS 50051	
		VIDRIO SEGURIDAD (4 + 4)		N° PILASTRAS x -1	(L1 -5) x (H-H1-H2-110)
	5070382	TORNILLO,TUERCA Y ARANDELA M6 INOX		2 X (N° PILAR)	
	5070041	JUNTA RANURA PILAR		N° PILAR	H-40
		TORNILLO INOXIDABLE		N° PILAR	M8x30
	5070512	TAPA PASAMANOS IZQUIERDA		1	
	5070513	TAPA PASAMANOS DERECHA		1	



7i m]b[ 'gV\Ya Yg - 7cfhY

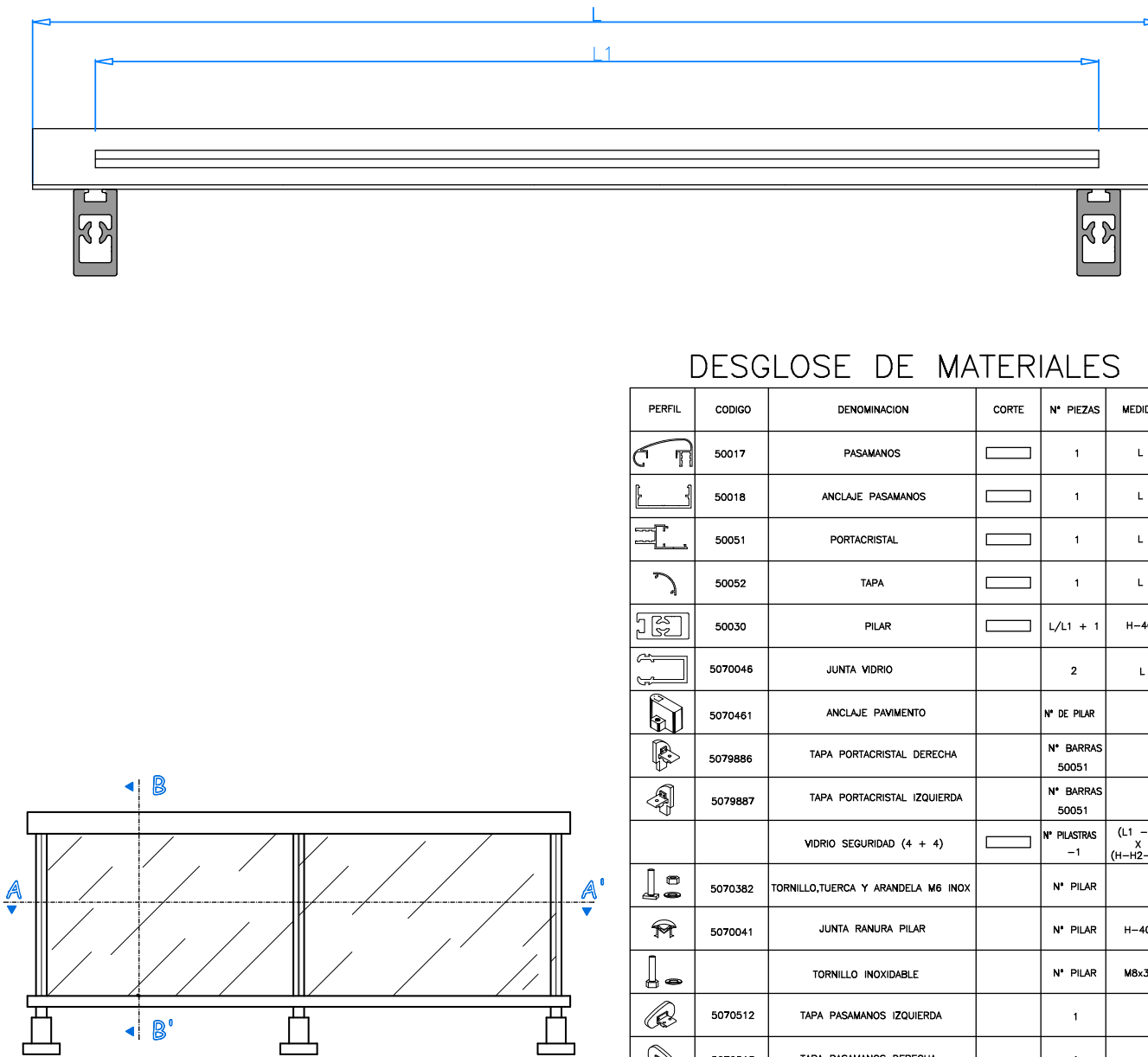
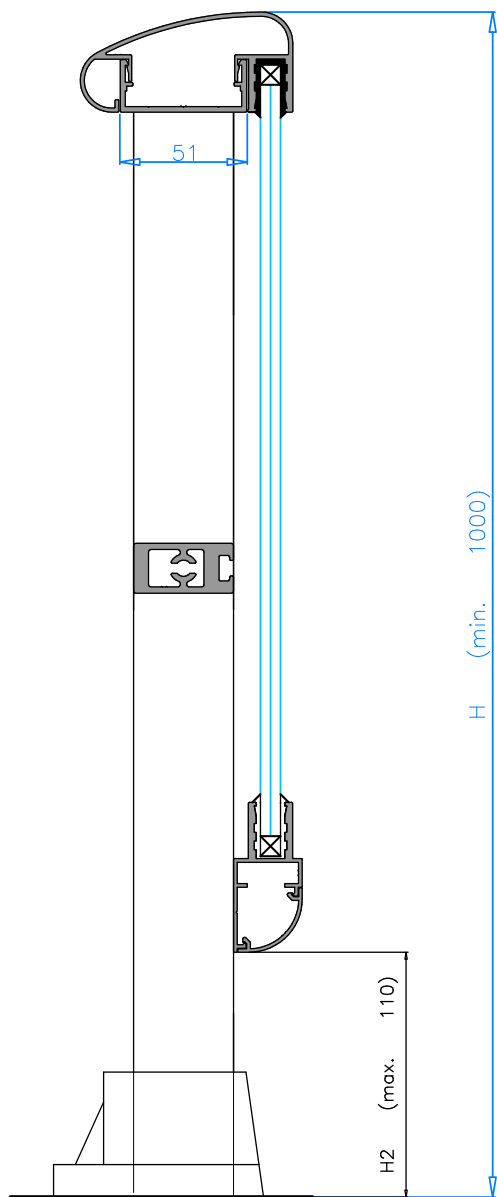

### DESGLOSE DE MATERIALES

PERFIL	CODIGO	DENOMINACION	CORTE	Nº PIEZAS	MEDIDA
	50017	PASAMANOS		1	L
	50018	ANCLAJE PASAMANOS		1	L
	50051	PORTACRISTAL		1	L
	50052	TAPA		1	L
	50030	PILAR		L/L1 + 1	H-40
	5070046	JUNTA VIDRIO		2	L
	5070461	ANCLAJE PAVIMENTO		Nº DE PILAR	
	5079886	TAPA PORTACRISTAL DERECHA		Nº BARRAS 50051	
	5079887	TAPA PORTACRISTAL IZQUIERDA		Nº BARRAS 50051	
		VIDRIO SEGURIDAD (4 + 4)		Nº PILASTRAS -1	$(L1 - 5) \times (H - H2 - 60)$
	5070382	TORNILLO,TUERCA Y ARANDELA M6 INOX		Nº PILAR	
	5070041	JUNTA RANURA PILAR		Nº PILAR	H-40
		TORNILLO INOXIDABLE		Nº PILAR	M8x30
	5070512	TAPA PASAMANOS IZQUIERDA		1	
	5070513	TAPA PASAMANOS DERECHA		1	