

GS-63 RT
PRACTICABLE CON
ROTURA DE PUENTE TÉRMICO

■ **PERFILES**

LISTADO DE PERFILES
PERFILES ESCALA 1:1



GS-63 RT - listado de perfiles

Ref.	Croquis	Descripción	Pág.	Ref.	Croquis	Descripción	Pág.
0631210		UMBRAL	10	72703		SOLAPE DE 60 mm	-
0631410		MARCO VENTANA	10	72704		SOLAPE DE 87 mm	-
0631411		MARCO VENTANA CON SOLAPE	11	72708		SOLAPE CURVO DE 60 mm	-
0631423		HOJA VENTANA APERTURA INTERIOR	11	73730		SOLAPE GRAPA DE 30 mm	-
0631424		HOJA DE VENTANA C16 APERTURA INTERIOR	12	73740		SOLAPE GRAPA DE 40 mm	-
0631430		TRAVESAÑO VENTANA	12	73750		SOLAPE GRAPA DE 50 mm	-
0631440		PERFIL INVERSOR	13	73760		SOLAPE GRAPA DE 60 mm	-
0631441		PERFIL INVERSOR C16	13	72800		SOLAPE DE 33 mm	-
0632210		MARCO VENTANA	14	72801		SOLAPE DE 33 mm	-
0634210		MARCO PUERTA	14				
0634223		HOJA PUERTA APERTURA INTERIOR	15				
0634224		HOJA PUERTA C16 APERTURA INTERIOR	15				
0634228		HOJA PUERTA C16 APERTURA EXTERIOR	16				
0634229		HOJA PUERTA APERTURA EXTERIOR	16				
0634230		TRAVESAÑO PUERTA	17				
0638730		ZÓCALO	17				
730424		SUPLEMENTO UMBRAL	18				
9820415		SUPLEMENTO ZÓCALO	18				
940422		FALLEBA	-				
940423		VIERTEAGUAS	-				
72701		SOLAPE DE 33 mm	-				
72702		SOLAPE DE 43 mm	-				

perfiles escala 1:1 - GS-63 RT

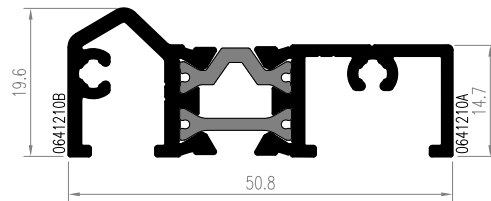

0631210

UMBRAL

Peso: 0,625 (Kg/m)

Perímetro: 29,1 (dm²/m)

Inercias: (Ix) 0,84 (cm⁴) (Iy) 6,07 (cm⁴)

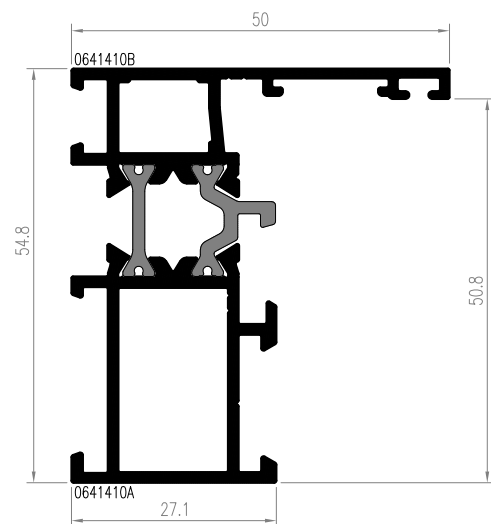

0631410

MARCO VENTANA

Peso: 0,971 (Kg/m)

Perímetro: 49,1 (dm²/m)

Inercias: (Ix) 4,5 (cm⁴) (Iy) 13,4 (cm⁴)



GS-63 RT - perfiles escala 1:1

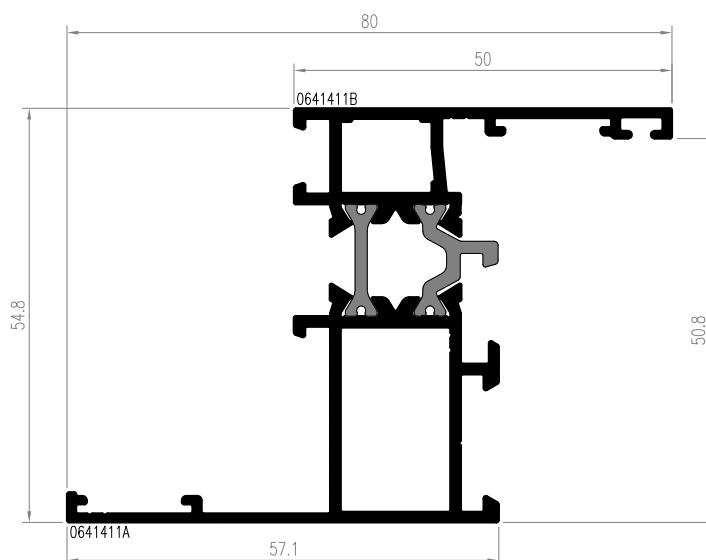

0631411

MARCO VENTANA CON SOLAPE

Peso: 1,081 (Kg/m)

Perímetro: 56,1 (dm²/m)

Inercias: (Ix) 6,08 (cm⁴) (Iy) 20 (cm⁴)

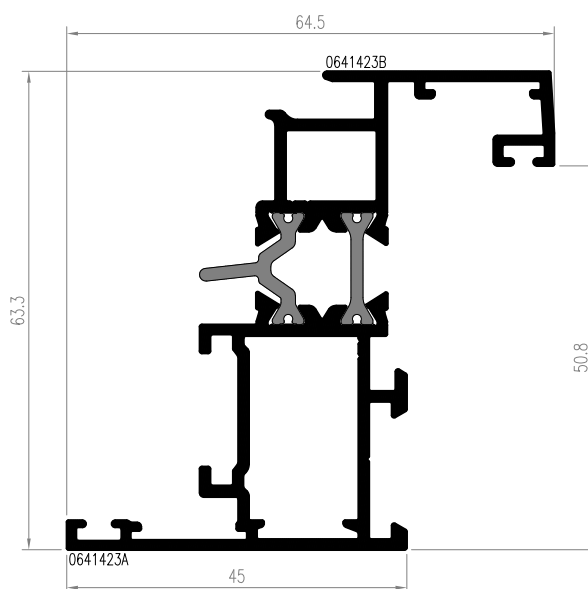

0631423

HOJA VENTANA APERTURA INTERIOR

Peso: 1,155 (Kg/m)

Perímetro: 59,6 (dm²/m)

Inercias: (Ix) 5,34 (cm⁴) (Iy) 33 (cm⁴)

perfiles escala 1:1 - GS-63 RT

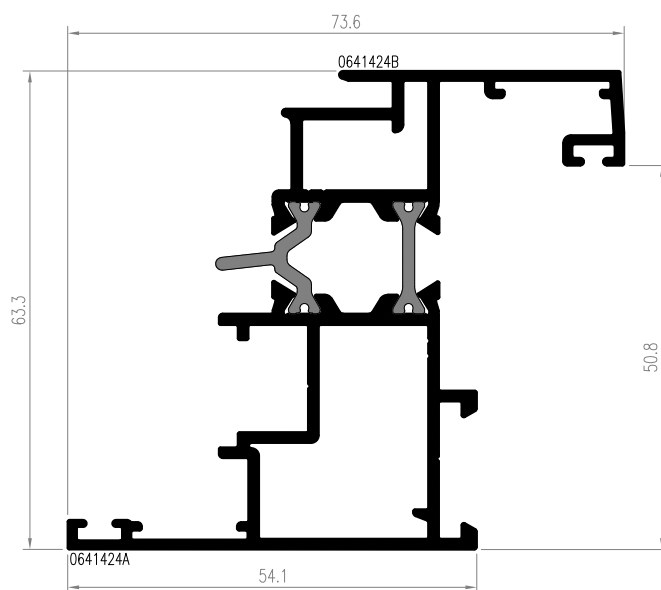

0631424

HOJA VENTANA C16 APERTURA INTERIOR

Peso: 1,281 (Kg/m)

Perímetro: 66,4 (dm²/m)

Inercias: (Ix) 7,7 (cm⁴) (Iy) 28,3 (cm⁴)

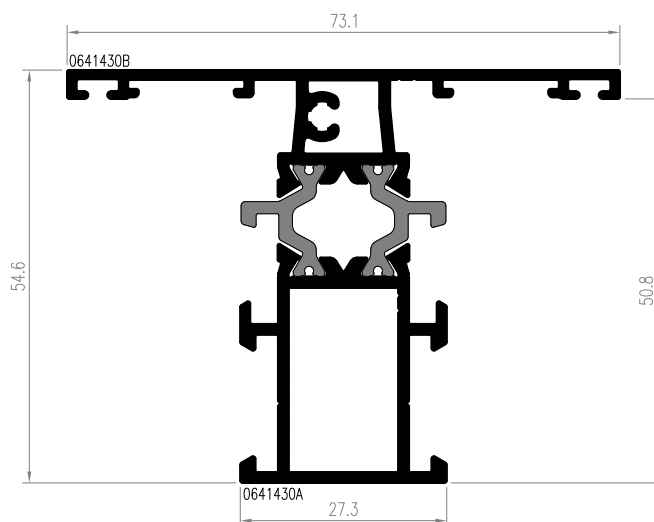

0631430

TRAVESAÑO VENTANA

Peso: 1,102 (Kg/m)

Perímetro: 57 (dm²/m)

Inercias: (Ix) 9,02 (cm⁴) (Iy) 22,7 (cm⁴)



GS-63 RT - perfiles escala 1:1

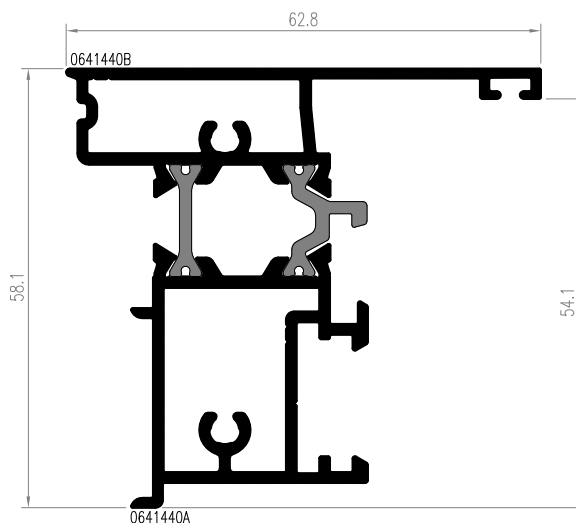

0631440

PERFIL INVERSOR

Peso: 1,189 (Kg/m)

Perímetro: 60,9 (dm²/m)

Inercias: (Ix) 8,98 (cm⁴) (Iy) 24,9 (cm⁴)

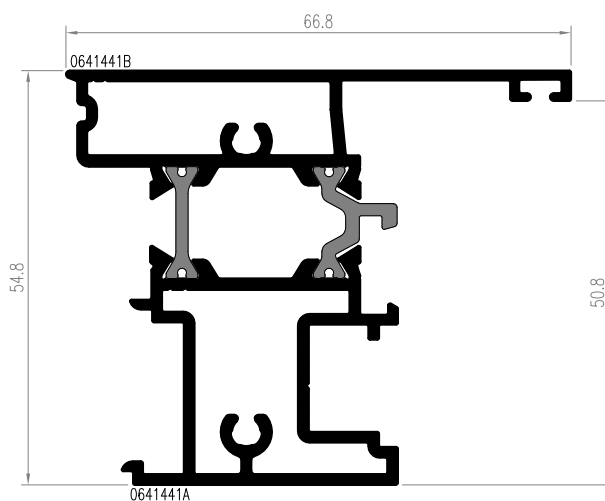

0631441

PERFIL INVERSOR C16

Peso: 1,286 (Kg/m)

Perímetro: 66,1 (dm²/m)

Inercias: (Ix) 10,36 (cm⁴) (Iy) 17,8 (cm⁴)

perfiles escala 1:1 - GS-63 RT

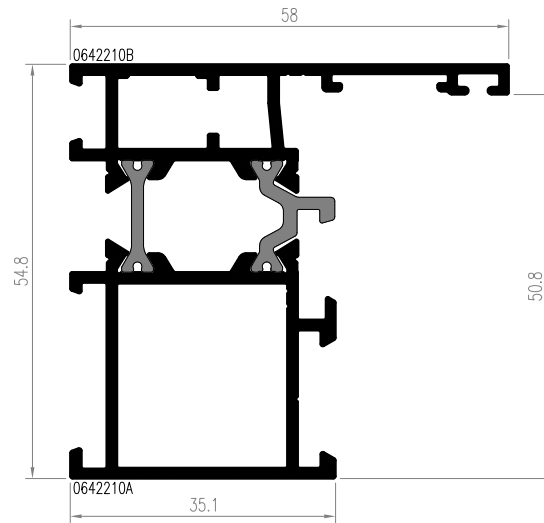

0632210

MARCO VENTANA

Peso: 1,112 (Kg/m)

Perímetro: 56,4 (dm²/m)

Inercias: (Ix) 4,5 (cm⁴) (Iy) 13,4 (cm⁴)

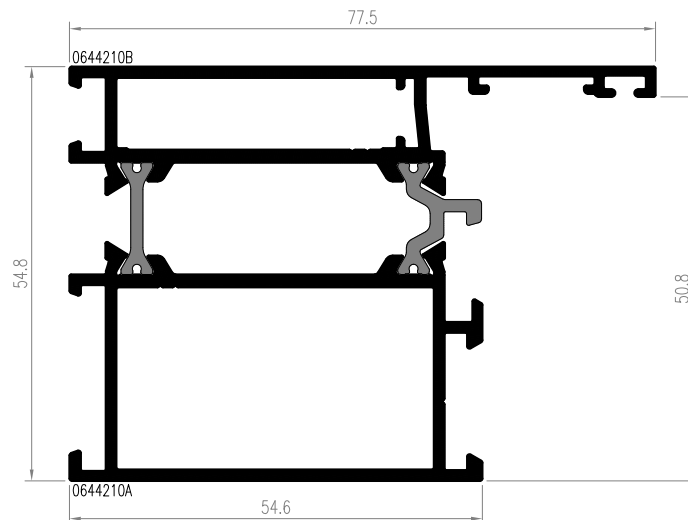

0634210

MARCO PUERTA

Peso: 1,476 (Kg/m)

Perímetro: 71,8 (dm²/m)

Inercias: (Ix) 24,9 (cm⁴) (Iy) 32,8 (cm⁴)



GS-63 RT - perfiles escala 1:1

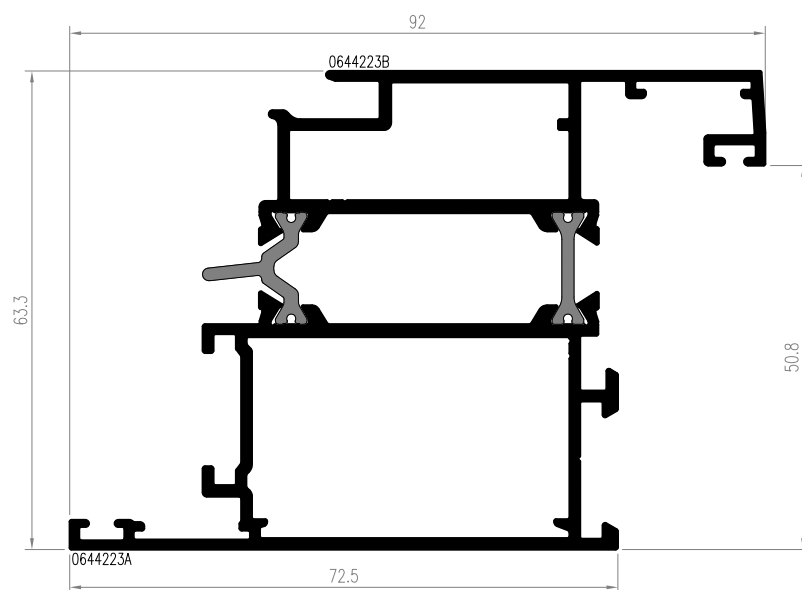

0634223

HOJA PUERTA APERTURA INTERIOR

Peso: 1,677 (Kg/m)

Perímetro: 83 (dm²/m)

Inercias: (Ix) 24,76 (cm⁴) (Iy) 53 (cm⁴)

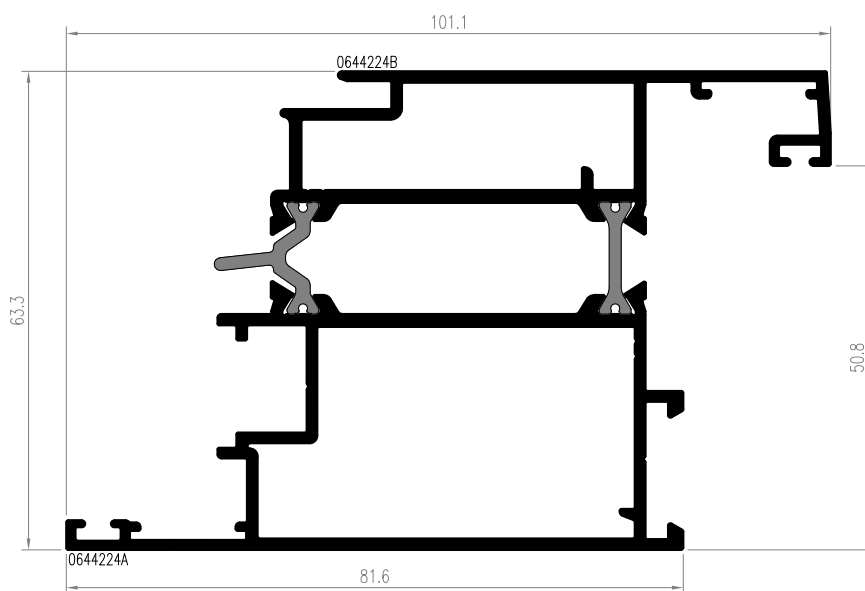

0634224

HOJA PUERTA C16 APERTURA INTERIOR

Peso: 1,787 (Kg/m)

Perímetro: 88,37 (dm²/m)

Inercias: (Ix) 24,04 (cm⁴) (Iy) 51 (cm⁴)

perfiles escala 1:1 - GS-63 RT

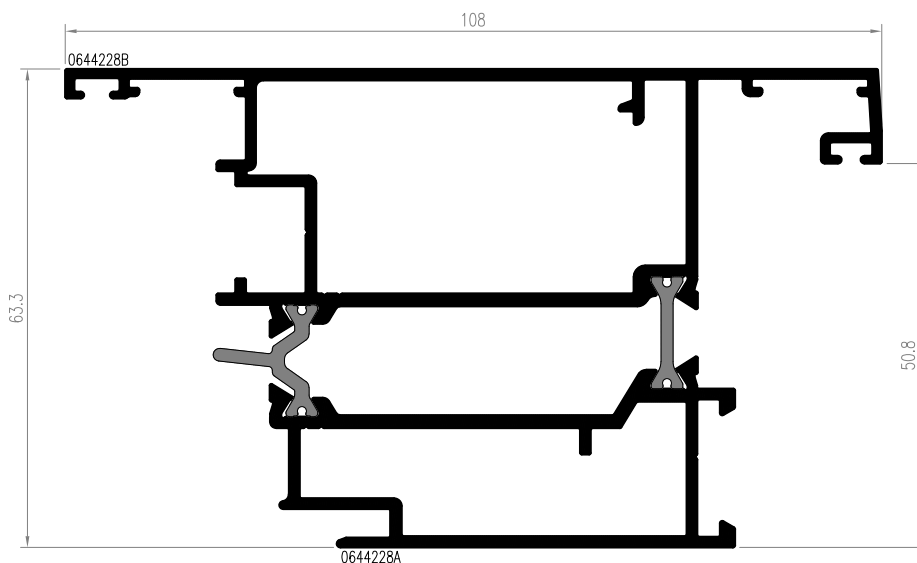

0634228

HOJA PUERTA C16 APERTURA EXTERIOR

Peso: 1,937 (Kg/m)

Perímetro: 95,87 (dm²/m)

Inercias: (Ix) 35,35 (cm⁴) (Iy) 54 (cm⁴)

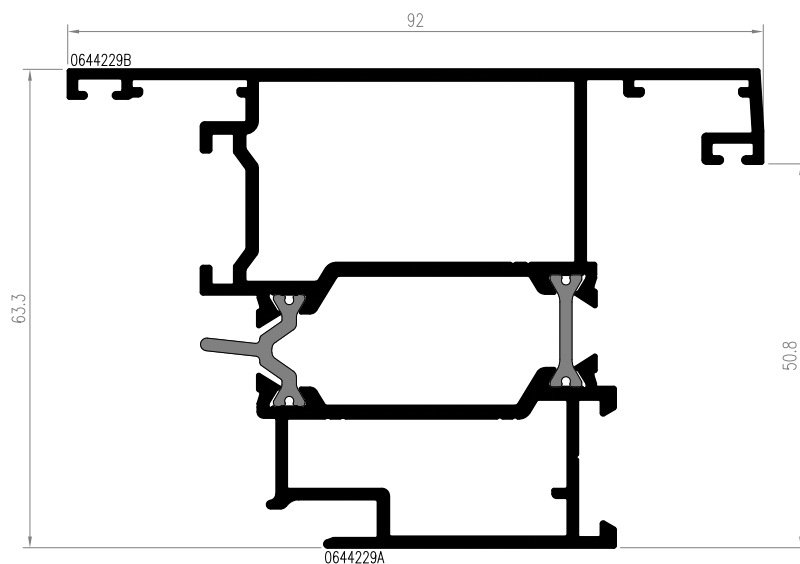

0634229

HOJA PUERTA APERTURA EXTERIOR

Peso: 1,680 (Kg/m)

Perímetro: 82,6 (dm²/m)

Inercias: (Ix) 34,55 (cm⁴) (Iy) 42,5 (cm⁴)



GS-63 RT - perfiles escala 1:1

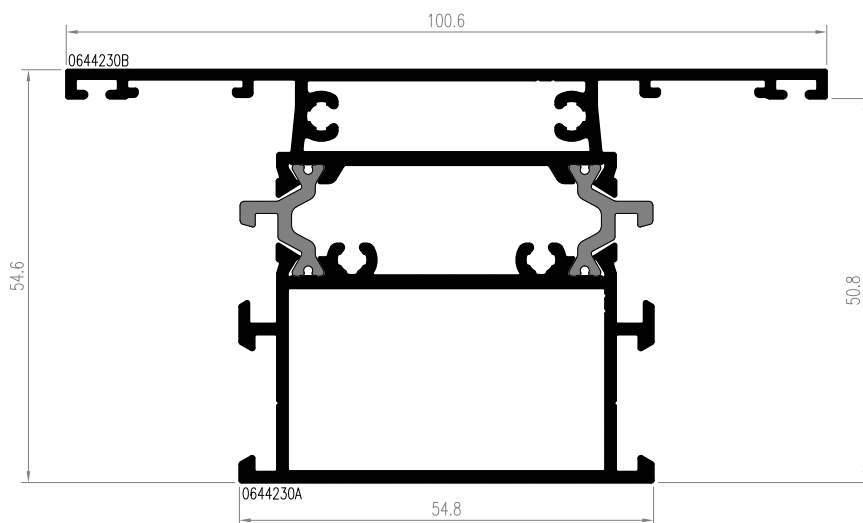

0634230

TRAVESAÑO PUERTA

Peso: 1,674 (Kg/m)

Perímetro: 83,4 (dm²/m)

Inercias: (Ix) 33,32 (cm⁴) (Iy) 36,9 (cm⁴)

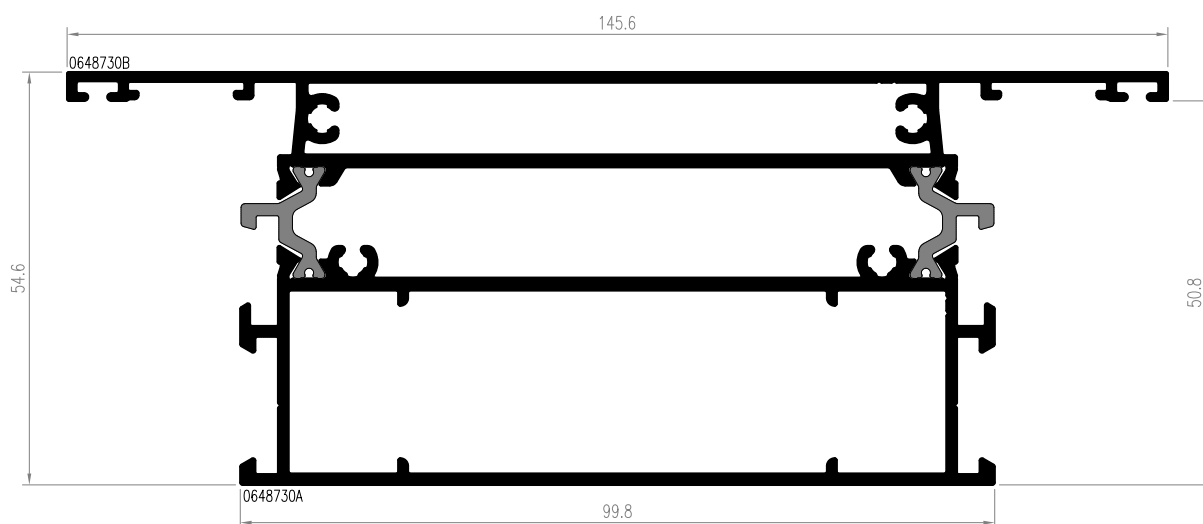

0638730

ZÓCALO

Peso: 2,469 (Kg/m)

Perímetro: 120,7 (dm²/m)

Inercias: (Ix) 33,41 (cm⁴) (Iy) 142 (cm⁴)



perfiles escala 1:1 - GS-63 RT

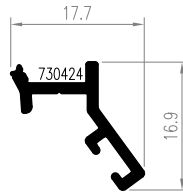

730424

SUPLEMENTO UMBRAL

Peso: 0,133 (Kg/m)

Perímetro: 78,8 (dm²/m)

Inercias: (Ix) 0,03 (cm⁴) (Iy) 0,19 (cm⁴)

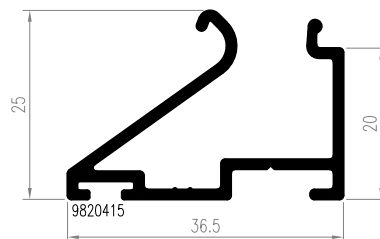

9820415

SUPLEMENTO ZÓCALO

Peso: 0,394 (Kg/m)

Perímetro: 21,9 (dm²/m)

Inercias: (Ix) 0,69 (cm⁴) (Iy) 2,11 (cm⁴)



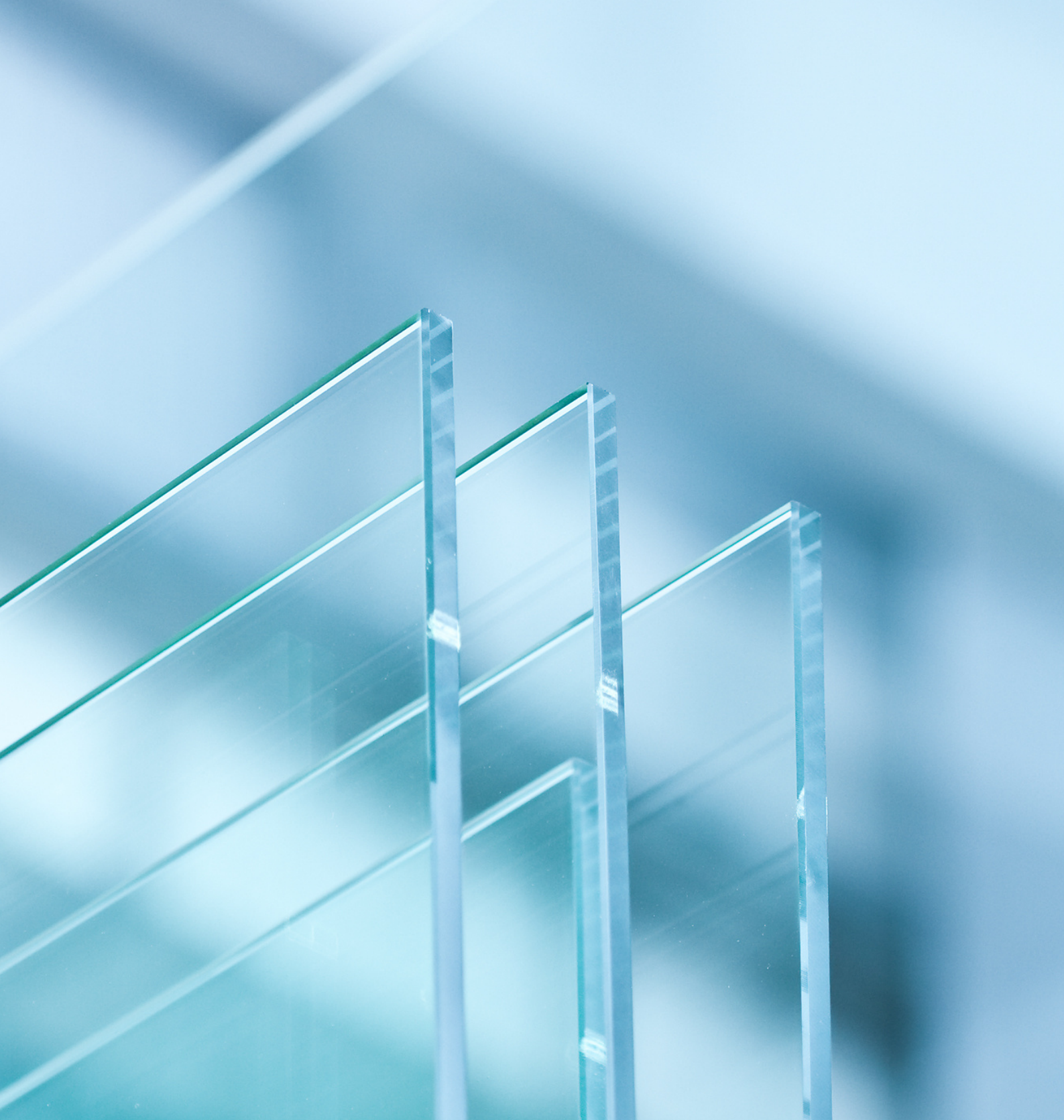

GS-63 RT























PRACTICABLE CON
ROTURA DE PUENTE TÉRMICO

■ **ACRISTALAMIENTO**

JUNQUILLOS
ACRISTALAMIENTO



GS-63 RT - junquillos

Ref.	Croquis	Descripción	Pág.	Ref.	Croquis	Descripción	Pág.
850308		JUNQUILLO RECTO 43,5 mm	22				
980301		JUNQUILLO RECTO 38,3 mm	22				
980302		JUNQUILLO RECTO 35,5 mm	22				
730329		JUNQUILLO RECTO 29,5 mm	22				
850307		JUNQUILLO RECTO 27,5 mm	22				
730325		JUNQUILLO RECTO 25,5 mm	22				
730323		JUNQUILLO RECTO 23,5 mm	22				
730317		JUNQUILLO RECTO 17,5 mm	22				
730313		JUNQUILLO RECTO 13,5 mm	22				
940304		JUNQUILLO RECTO 9,5 mm	22				
102308		JUNQUILLO RECTO 2 mm	22				
940320		JUNQUILLO CURVO 29,5 mm	22				
940321		JUNQUILLO CURVO 23,5 mm	22				
940322		JUNQUILLO CURVO 17,5 mm	22				
940323		JUNQUILLO CURVO 13,5 mm	22				
940324		JUNQUILLO CURVO 9,5 mm	22				
940310		JUNQUILLO GRAPA 29,5 mm	22				
940311		JUNQUILLO GRAPA 23,5 mm	22				
940312		JUNQUILLO GRAPA 17,5 mm	22				
940313		JUNQUILLO GRAPA 13,5 mm	22				
940314		JUNQUILLO GRAPA 9,5 mm	22				
940305		JUNQUILLO GRAPA 2,6 mm	22				

acristalamiento - GS-63 RT

Hueco	Junta exterior (A)	Vidrio	Junta acristalar interior (B)	Recto clipado	Curvo clipado	Curvo grapa
48,8 mm	9998216 3 mm	42	9998236 3 mm			
		41	9998246 4 mm			
		40	9998256 5 mm			
		39	9998266 6 mm			
		37	9998286 8 mm			
48,2 mm	9998216 3 mm	42	9998236 3 mm			
		41	9998246 4 mm			
		40	9998256 5 mm			
		39	9998266 6 mm			
		37	9998286 8 mm			
41,3 mm	9998216 3 mm	35	9998236 3 mm			
		34	9998246 4 mm			
		33	9998256 5 mm			
		32	9998266 6 mm			
		30	9998286 8 mm			
37,3 mm	9998216 3 mm	31	9998236 3 mm			
		30	9998246 4 mm			
		29	9998256 5 mm			
		28	9998266 6 mm			
		26	9998286 8 mm			
33,3 mm	9998216 3 mm	27	9998236 3 mm			
		26	9998246 4 mm			
		25	9998256 5 mm			
		24	9998266 6 mm			
		22	9998286 8 mm			
27,3 mm	9998216 3 mm	21	9998236 3 mm			
		20	9998246 4 mm			
		19	9998256 5 mm			
		18	9998266 6 mm			
		16	9998286 8 mm			
25,3 mm	9998216 3 mm	19	9998236 3 mm			
		18	9998246 4 mm			
		17	9998256 5 mm			
		16	9998266 6 mm			
		14	9998286 8 mm			
23,3 mm	9998216 3 mm	17	9998236 3 mm			
		16	9998246 4 mm			
		15	9998256 5 mm			
		14	9998266 6 mm			
		12	9998286 8 mm			
21,3 mm	9998216 3 mm	15	9998236 3 mm			
		14	9998246 4 mm			
		13	9998256 5 mm			
		12	9998266 6 mm			
		10	9998286 8 mm			
15,3 mm	9998216 3 mm	9	9998236 3 mm			
		8	9998246 4 mm			
		7	9998256 5 mm			
		6	9998266 6 mm			
		4	9998286 8 mm			

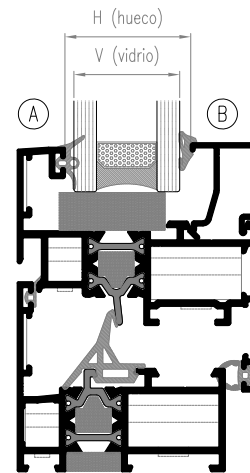

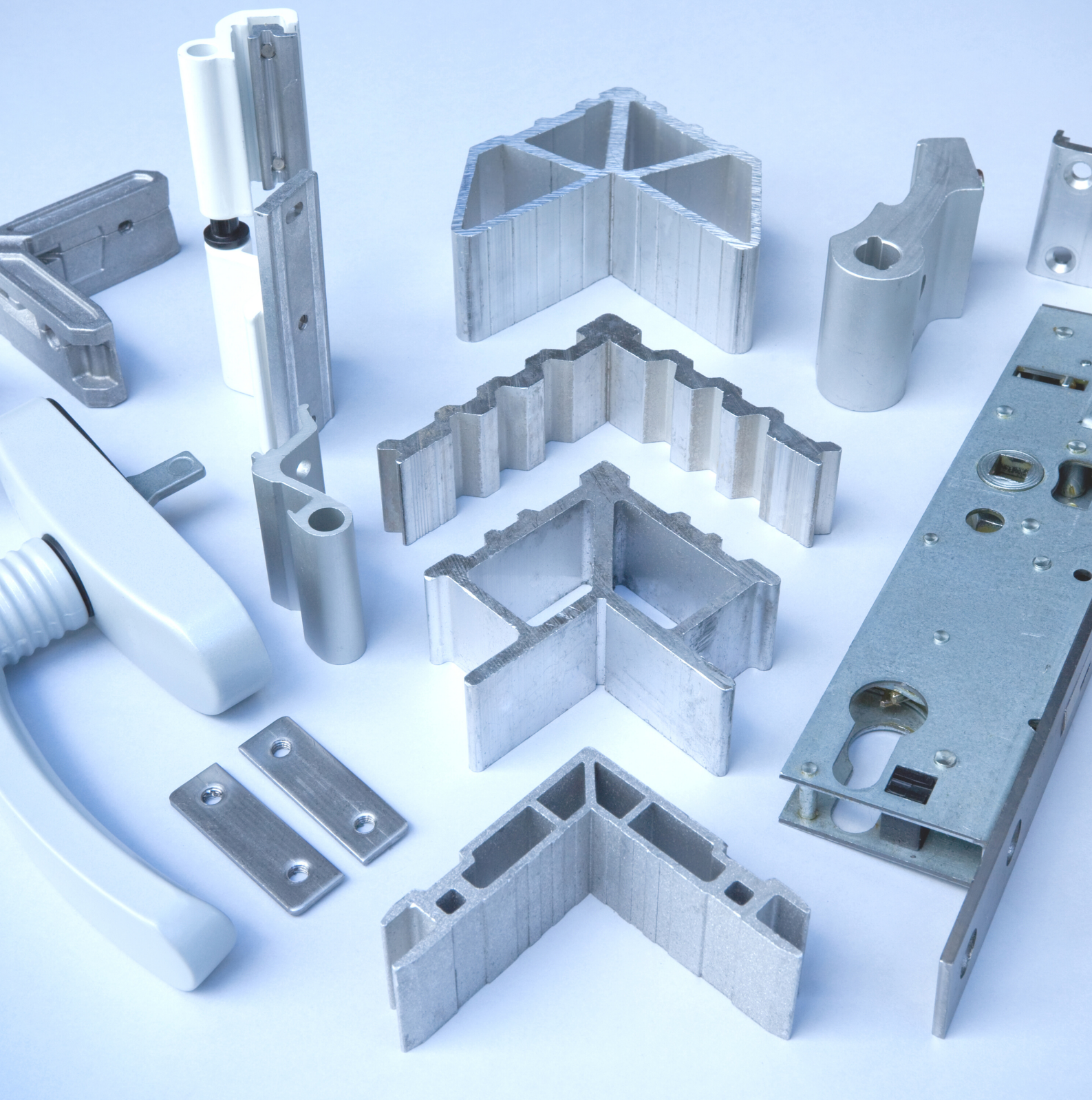

■ ACCESORIOS

ACCESORIOS

GS-63 RT

PRACTICABLE CON
ROTURA DE PUENTE TÉRMICO



GS-63 RT - accesorios

Referencia	Croquis	Descripción	Referencia	Croquis	Descripción
6300121		ESCUADRA EUROPEA EXTERIOR VENTANA 9x12 T-4 SERIES GS-63/73/83/88 RT	6303123		TAPAS PERFIL INVERSOR GS-63 RT
6300141		ESCUADRA EUROPEA VENTANA 24x14 T-8 SERIE GS-63/73/83/88 RT	6303133		TAPAS PERFIL INVERSOR GS-63 RT CANAL 16
6300221		ESCUADRA EUROPEA MARCO 24x22 T-8 SERIE GS-63/73/83/88 RT	6303203		GRAPA GRANDE TAPAJUNTAS INTERIOR MARCO SERIES ROTURA
6300361		ESCUADRA EUROPEA BALCONERA 8,5x36 T-4 SERIE GS-63/73/83/88 RT	6303213		GRAPA PEQUEÑA TAPAJUNTAS INTERIOR Y EXTERIOR, GUÍAS PERSIANA, SERIES FRÍAS
6300411		ESCUADRA EUROPEA MARCO-HOJA BALCONERA 41x24 T-8 SERIES GS-63/73/83/88 RT	0943434		COMPÁS ABATIBLE DESMONTABLE DE ACERO DE 220 mm
6300103		ESCUADRA JUNTA CENTRAL VULCANIZADA GS-63 RT C.E.	0943444		JUEGO COMPÁS ABATIBLE DESMONTABLE DE ACERO DE 150 mm
0980705		ESCUADRA ALINEAMIENTO INOXIDABLE PARA HOJA	0943454		COMPÁS LÍMITE DE APERTURA IZQUIERDA - DERECHA
6302141		UNIÓN EUROPEA DE BLOQUEO Y DESLIZAMIENTO 14x18 SERIES GS-63/73/83/88 RT	0943464		COMPÁS LIMITADOR DE APERTURA LARGO DE 482 mm IZQUIERDA DERECHA
6302411		UNIÓN EUROPEA DE BLOQUEO Y DESLIZANTE DE 41x18 GS-63/73/83/88 RT	0943474		JUEGO COMPÁS PROYECTANTE DESLIZANTE DE ACERO PARA C.E. DE 420 mm HASTA 100 Kg
0942381		BISAGRA SOBREPUESTA EUROPEA DESMONTADA C.E.	0943441		COMPÁS SUPLEMENTARIO OSCIOBATIENTE
0942391		JUEGO BISAGRA SOBREPUESTA C.E. REGULABLE 110 Kg	0543500		KIT UNA HOJA OSCIOBATIENTE COMPÁS CORTO DERECHA O IZQUIERDA (402-750) PARA 150 Kg
0852401		JUEGO BISAGRA SOBREPUESTA EUROPEA C.E. REGULABLE GALICUBE HOJA PASIVA 130 Kg	0543510		KIT UNA HOJA OSCIOBATIENTE COMPÁS MEDIANO DERECHA O IZQUIERDA (562-1200) PARA 150 Kg
0942401		BISAGRA SOBREPUESTA DERECHA C.E.	0543520		KIT COMPLETO OSCIOBATIENTE 2 HOJAS COMPÁS CORTO DERECHA O IZQUIERDA (402-750) PARA 150 Kg
0942411		BISAGRA SOBREPUESTA IZQUIERDA C.E.	0543530		KIT COMPLETO OSCIOBATIENTE 2 HOJAS COMPÁS MEDIANO DERECHA O IZQUIERDA (562-1200) PARA 150 Kg
0942481		CASQUILLO EXCÉNTRICO DE AJUSTE PARA BISAGRA GRIP	0543540		KIT APERTURA PARA BISAGRA OCULTA OSCIOBATIENTE A DERECHAS CORTO (422-900) 180 Kg
0942601		BISAGRA 3ª HOJA C.E.	0543550		KIT APERTURA PARA BISAGRA OCULTA OSCIOBATIENTE A IZQUIERDAS CORTO (422-900) 180 Kg
0942721		BISAGRA PUERTA DE 3 ALAS C.E.	0543560		KIT APERTURA PARA BISAGRA OCULTA OSCIOBATIENTE A DERECHAS LARGO (700-1700) 180 Kg
0942731		BISAGRA TRES CUERPOS C.E.	0543570		KIT APERTURA PARA BISAGRA OCULTA OSCIOBATIENTE A IZQUIERDA LARGO (700-1700) 180 Kg
0942741		BISAGRA DE PUERTA REGULABLE MONZA 2 ALAS C.E.	0543580		KIT APERTURA BISAGRA OCULTA A DERECHA 180 Kg
0942751		BISAGRA DE PUERTA 3ª HOJA 2 ALAS C.E.	0543590		KIT APERTURA BISAGRA OCULTA A IZQUIERDA 180 Kg
0942761		BISAGRA DE PUERTA 4ª HOJA 2 ALAS C.E.	0543600		BISAGRAS OCULTAS PARA VENTANA ABATIBLE CON CAPACIDAD DE 150 Kg HOJA
0943113		SALIDA DE AGUA	0943601		COMPÁS OSCIOBATIENTE REDUCIDO (364-700)

⚠ Los accesorios marcados únicamente se suministrarán bajo pedido.

accesorios - GS-63 RT

Referencia	Croquis	Descripción	Referencia	Croquis	Descripción
0943611		COMPÁS OSCILOBATIENTE LARGO (816-1700)	0946524		MECANISMO PARA MANILLA EN ACERO MARTELLINA OLIMPO
0943621		COMPÁS OSCILOBATIENTE MEDIANO (562-1200)	0946532		CIERRE PASADOR DE PALANCA BIDIRECCIONAL HOJA PASIVA
0943631		COMPÁS OSCILOBATIENTE MEDIANO (402-750)	0946533		UNIDAD PASADOR 2ª HOJA PASIVA
0944012		CREMONA 2 PALAS PRACTICABLE C.E.	0946534		EMPALME PARA CREMONAS DE UNA PALA
0944022		CREMONA 1 PALA PRACTICABLE Y OSCILOBATIENTE C.E.	0946542		KIT 2 HOJAS PRACTICABLES C.E.
0944052		CREMONA 2 PALAS PRACTICABLE C.E. CON LLAVE	0946543		JUEGO PATÍN APOYO HOJA SOBRE MARCO
0944062		MANETA APERTURA EOS CUADRADILLO DE 7 mm x 23 mm	0946552		ENCUENTRO PASADOR PARA UNA HOJA O DOS HOJAS
0944072		MANETA APERTURA EOS CUADRADILLO DE 7 mm x 48 mm	0946562		CERRADERO SIMPLE DE NYLON PARA CÁMARA EUROPEA
0944082		MANETA EOS CUADRADILLO DE 7 mm CON LLAVE	0946572		TERMINAL DE PLETINA MANDO PASADOR DE PALANCA BIDIRECCIONAL HOJA PASIVA
0944102		CREMONA PARA APERT. EXTERIOR GAIA	0946570		MECANISMO MICROVENTILACIÓN
0944112		MANETA APERTURA OLIMPO CUADRADILLO DE 7 mm SIN ESCUDO	0946584		CERRADERO A MARCO FIJO SERIES PRACTICABLES C.E.
0944122		CIERRE A PRESIÓN CON RODILLO A DERECHA, ENGANCHE NYLON	0946592		EJE EXCÉNTRICO CIERRE SUPLEMENTARIO PARA PRACTICABLES C.E.
0944092		CREMONA 1 PALA PRACTICABLE Y OSCILOBATIENTE CON LLAVE C.E.	0946594		UNIDAD PASADOR 2ª HOJA METÁLICO A LEVA SUPERIOR
0944412		MANILLA DOBLE FLEXIPOR	0946604		UNIDAD PASADOR 2ª HOJA METÁLICO A LEVA INFERIOR
0944712		CIERRE DE GOLPETE PARA SERIES C.E. ABISAGRADAS	0946613		UNIDAD PASADOR 2ª HOJA EN NYLON 2ª CANAL 20 C.E.
0824904		KIT FIJACIÓN DOBLE MANILLA CUADRADILLO 7 mm L=85 mm CON TORNILLERÍA	0946614		MECANISMO BIDIRECCIONAL AGUJA 33,5 mm PARA APERTURA EXTERIOR
0824914		KIT FIJACIÓN DOBLE MANILLA CUADRADILLO 7 mm L=64 mm	0946624		UNIDAD PASADOR OSCILOBATIENTE Y APERTURAS PRACTICABLES DE 215 mm
0945014		CAJA TRM 33.5 PRACTICABLE C.E. APERTURA EXTERIOR 90°	0946634		CIERRE DE PESTILLO
0945414		EJE CUADRADILLO 7 mm L=131 mm LARGO	0946645		TORNILLO ANTIROBO DE ACERO INOXIDABLE PARA BISAGRAS MONZA, VENICE
0945434		CERRADERO REGULABLE METÁLICO PARA SERIES CE	0946644		CERRADERO MARCO PASADOR METÁLICO REGULABLE
0955992		CIERRA PUERTAS SIN RETENCIÓN SM-95 RF	0946654		CERRADERO PALANCA INFERIOR METÁLICO REGULABLE
0946513		KIT 1 HOJA PRACTICABLE C.E.	0946664		UNIDAD PASADOR 2ª HOJA METÁLICO-NYLON LARGO SUPERIOR



GS-63 RT - accesorios

Referencia	Croquis	Descripción	Referencia	Croquis	Descripción
0946674		PUNTO CIERRE SUPLEMENTARIO PRACTICABLES C.E.	6308236		AISLAMIENTO INTERIOR TRAVESAÑO ANCHO POLIAMIDA L= 800
0946684		UNIDAD PASADOR OSCILOBATIENTE DE 220 mm	9998236		JUNTA ACRISTALAMIENTO DE CUÑA DE 3 mm
0946694		CIERRE DE CONTRASTE OCULTO LADO BISAGRA CON REGULACIÓN	6308246		AISLAMIENTO INTERIOR INVERSOR POLIAMIDA L= 800 CANAL 16
0946712		CIERRE SUPLEMENTARIO HORIZONTAL OSCILOBATIENTE C.E.	9998246		JUNTA ACRISTALAMIENTO DE CUÑA DE 4 mm
0946722		CIERRE SUPLEMENTARIO HORIZONTAL Y VERTICAL C.E.	9998256		JUNTA ACRISTALAMIENTO DE CUÑA DE 5 mm
0946732		KIT CIERRE SUPLEMENTARIO VERTICAL 1 HOJA OSCILOBATIENTE C.E.	6308266		AISLAMIENTO INTERIOR HOJA BALCONERA APERTURA INTERIOR POLIAMIDA L= 800 CANAL 16
0946752		KIT BASE CIERRE SUPLEMENTARIO VERTICAL 2 HOJAS OSCILOBATIENTE C.E.	9998266		JUNTA ACRISTALAMIENTO DE CUÑA DE 6/7 mm
6308076		JUNTA BATIENTE GS-63/73/83/88 RT	6308276		AISLAMIENTO INTERIOR HOJA BALCONERA APERTURA EXTERIOR POLIAMIDA L= 800 CANAL 16
0948083		FALLEBA C.E. EN PVC TODAS SERIES	9998286		JUNTA ACRISTALAMIENTO DE CUÑA DE 8/9 mm
6308106		JUNTA CENTRAL MARCO GS-63 RT	6308306		AISLAMIENTO INTERIOR MARCO 27 mm L= 800
6308126		AISLAMIENTO INTERIOR MARCO Y HOJA VENTANA L= 800	6309014		TROQUEL MECANIZADO ESCUADRAS MARCO/HOJA SERIES GS-63,73,83,88,54,67,94
6308136		AISLAMIENTO INTERIOR TRAVESAÑO L= 800	6309024		TROQUEL MECANIZADO ESCUADRAS MARCO/HOJA SERIES GS-63,73,83,88 CANAL 16
6308146		AISLAMIENTO INTERIOR HOJA POLIAMIDA TUBULAR L= 800 CANAL 16			
6308176		AISLAMIENTO INTERIOR INVERSOR POLIAMIDA L= 800			
0708153		UNIÓN DE MARCOS EN POLIAMIDA			
6308186		AISLAMIENTO INTERIOR MARCO Y HOJA BALCONERA APERTURA INTERIOR POLIAMIDA L= 800			
6308206		AISLAMIENTO INTERIOR HOJA BALCONERA APERTURA EXTERIOR POLIAMIDA L= 800			
0948216		JUNTA EXTERIOR MARCO DE PRESIÓN SERIES PRACTICABLES Y JUNQUILLOS GS-70 RT HO			
6308216		AISLAMIENTO EXTERIOR TECNOLEN EN MARCO 24x5 SERIE GS-63 RT			
6308226		AISLAMIENTO EXTERIOR TECNOLEN ENTRE VIDRIO HOJA, MARCO Y TRAVESAÑO 28x10 SERIE GS-63 RT			
9998216		JUNTA ACRISTALAMIENTO EXTERIOR DE 3 mm			
9998226		JUNTA ACRISTALAMIENTO EXTERIOR DE 6 mm			