

■ SECCIONES

SECCIONES

GS-73 RT

PRACTICABLE CON
ROTURA DE PUENTE TÉRMICO



GS-73 RT - secciones

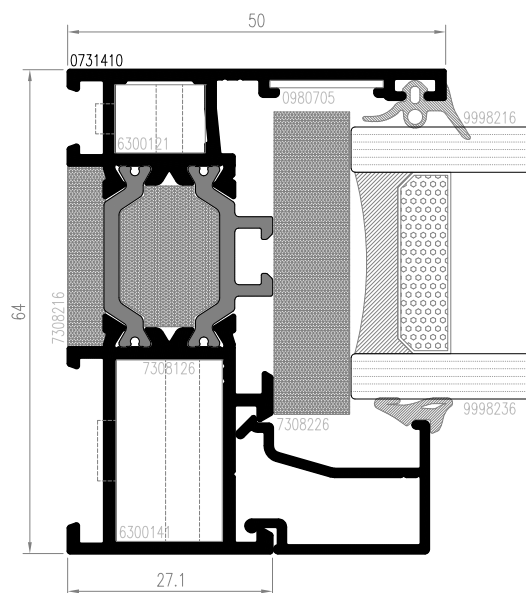

Ref.	Descripción	Ref.	Descripción
0731410	MARCO VENTANA	7308216	AISLANTE TÉRMICO MARCO EXTERIOR
0980705	ESCUADRA ALINEAMIENTO	7308226	AISLANTE TÉRMICO MARCO/VIDRIO
6300121	ESCUADRA EXTERIOR MARCO	9998216	JUNTA ACRISTALAMIENTO EXTERIOR
6300141	ESCUADRA INTERIOR MARCO	9998236	JUNTA ACRISTALAMIENTO 3 mm
7308126	AISLANTE TÉRMICO MARCO EN POLIAMIDA		

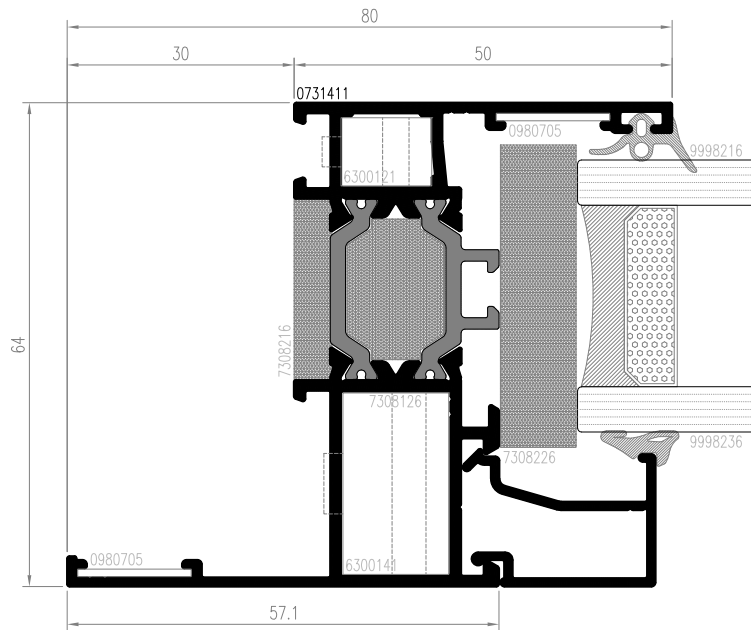

Ref.	Descripción	Ref.	Descripción
0731411	MARCO VENTANA CON SOLAPE	7308216	AISLANTE TÉRMICO MARCO EXTERIOR
0980705	ESCUADRA ALINEAMIENTO	7308226	AISLANTE TÉRMICO MARCO/VIDRIO
6300121	ESCUADRA EXTERIOR MARCO	9998216	JUNTA ACRISTALAMIENTO EXTERIOR
6300141	ESCUADRA INTERIOR MARCO	9998236	JUNTA ACRISTALAMIENTO 3 mm
7308126	AISLANTE TÉRMICO MARCO EN POLIAMIDA		



GS-73 RT - secciones

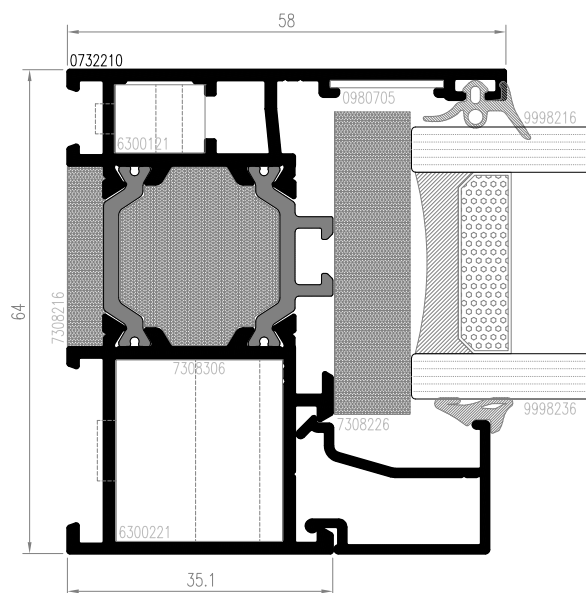

Ref.	Descripción	Ref.	Descripción
0732210	MARCO VENTANA	7308226	AISLANTE TÉRMICO MARCO/VIDRIO
0980705	ESCUADRA ALINEAMIENTO	7308306	AISLANTE TÉRMICO MARCO EN POLIAMIDA
6300121	ESCUADRA EXTERIOR MARCO	9998216	JUNTA ACRISTALAMIENTO EXTERIOR
6300221	ESCUADRA INTERIOR MARCO	9998236	JUNTA ACRISTALAMIENTO 3 mm
7308216	AISLANTE TÉRMICO MARCO EXTERIOR		

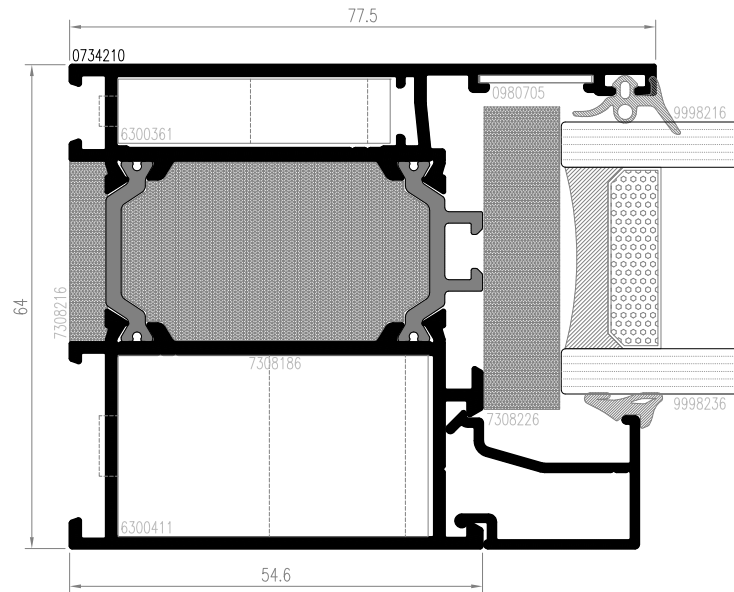

Ref.	Descripción	Ref.	Descripción
0734210	MARCO PUERTA	7308216	AISLANTE TÉRMICO MARCO EXTERIOR
0980705	ESCUADRA ALINEAMIENTO	7308226	AISLANTE TÉRMICO MARCO/VIDRIO
6300361	ESCUADRA EXTERIOR MARCO	9998216	JUNTA ACRISTALAMIENTO EXTERIOR
6300411	ESCUADRA INTERIOR MARCO	9998236	JUNTA ACRISTALAMIENTO 3 mm
7308186	AISLANTE TÉRMICO MARCO EN POLIAMIDA		



GS-73 RT - secciones

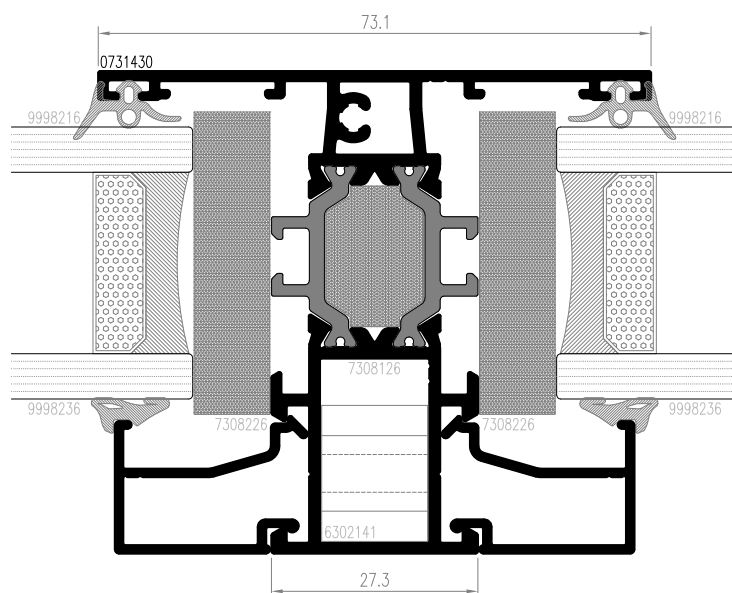

Ref.	Descripción	Ref.	Descripción
0731430	TRAVESAÑO VENTANA	7308226	AISLANTE TÉRMICO TRAVESAÑO/VIDRIO
6302141	UNIÓN EUROPEA TRAVESAÑO VENTANA	9998216	JUNTA ACRISTALAMIENTO EXTERIOR
7308126	AISLANTE TÉRMICO TRAVESAÑO EN POLIAMIDA	9998236	JUNTA ACRISTALAMIENTO 3 mm

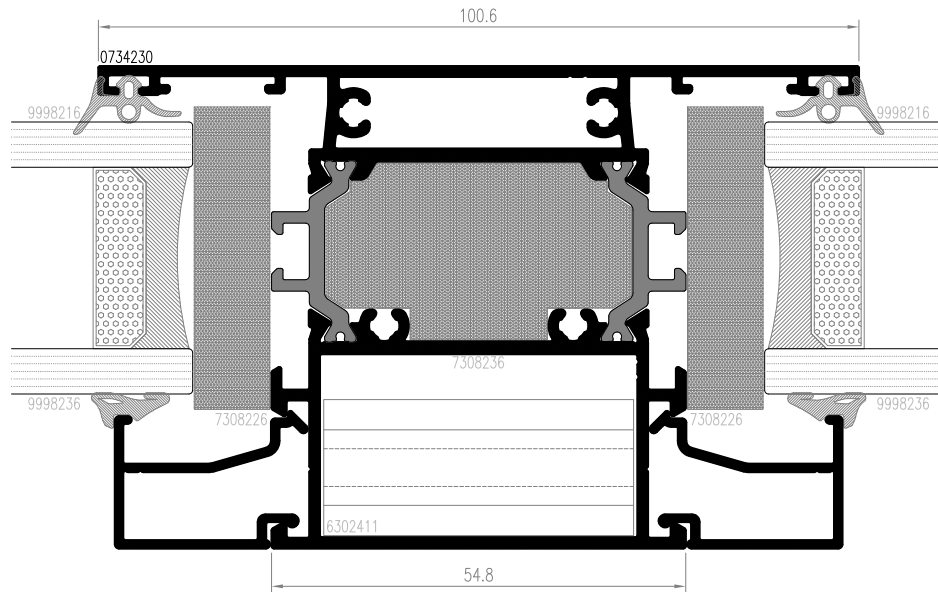

Ref.	Descripción	Ref.	Descripción
0734230	TRAVESAÑO PUERTA	7308236	AISLANTE TÉRMICO TRAVESAÑO EN POLIAMIDA
6302411	UNIÓN EUROPEA TRAVESAÑO PUERTA	9998216	JUNTA ACRISTALAMIENTO EXTERIOR
7308226	AISLANTE TÉRMICO TRAVESAÑO/VIDRIO	9998236	JUNTA ACRISTALAMIENTO 3 mm



GS-73 RT - secciones

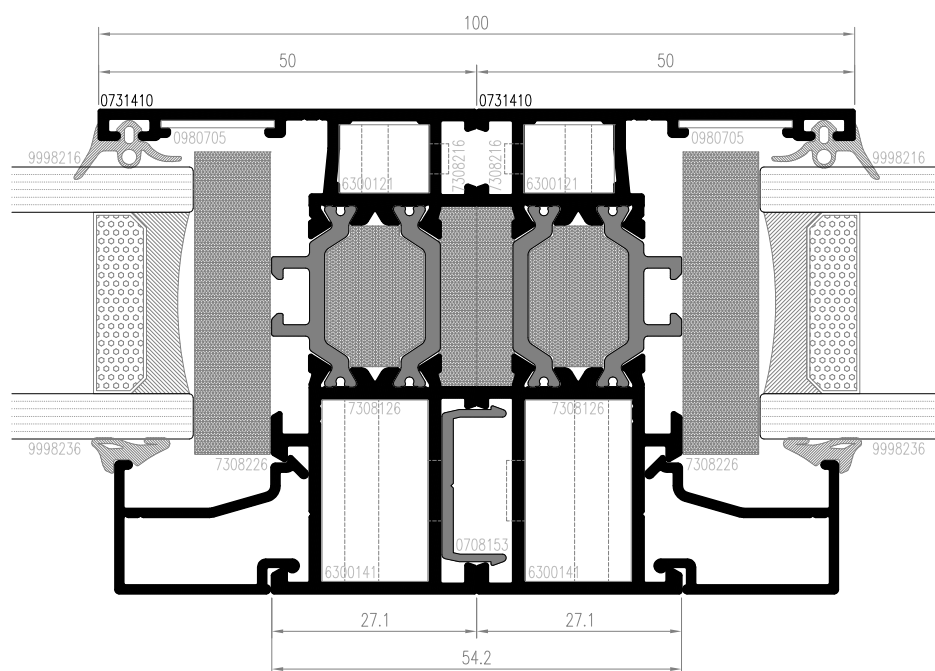

Ref.	Descripción	Ref.	Descripción
0731410	MARCO VENTANA	7308126	AISLANTE TÉRMICO MARCO EN POLIAMIDA
0708153	UNIÓN DE MARCOS	7308216	AISLANTE TÉRMICO MARCO EXTERIOR
0980705	ESCUADRA ALINEAMIENTO	7308226	AISLANTE TÉRMICO MARCO/VIDRIO
6300121	ESCUADRA EXTERIOR MARCO	9998216	JUNTA ACRISTALAMIENTO EXTERIOR
6300141	ESCUADRA INTERIOR MARCO	9998236	JUNTA ACRISTALAMIENTO 3 mm



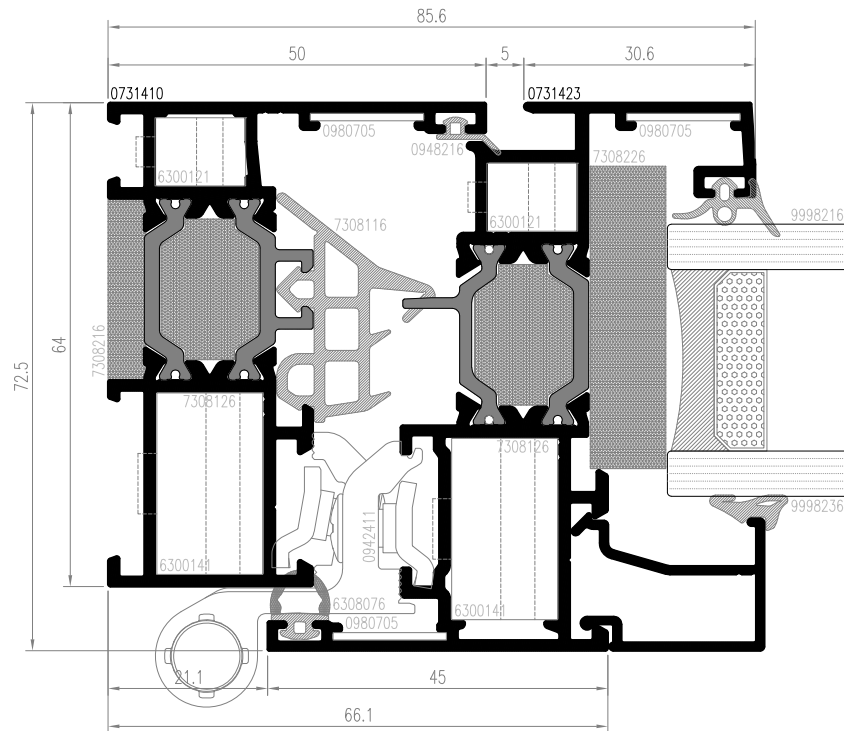

Ref.	Descripción	Ref.	Descripción
0731410	MARCO VENTANA	6308076	JUNTA HOJA
0731423	HOJA VENTANA	7308116	JUNTA CENTRAL
0942411	BISAGRA A IZQUIERDAS	7308126	AISLANTE TÉRMICO MARCO/HOJA EN POLIAMIDA
0948216	JUNTA MARCO	7308216	AISLANTE TÉRMICO MARCO EXTERIOR
0980705	ESCUADRA ALINEAMIENTO	7308226	AISLANTE TÉRMICO HOJA/VIDRIO
6300121	ESCUADRA EXTERIOR MARCO/HOJA	9998216	JUNTA ACRISTALAMIENTO EXTERIOR
6300141	ESCUADRA INTERIOR MARCO/HOJA	9998236	JUNTA ACRISTALAMIENTO 3 mm



GS-73 RT - secciones

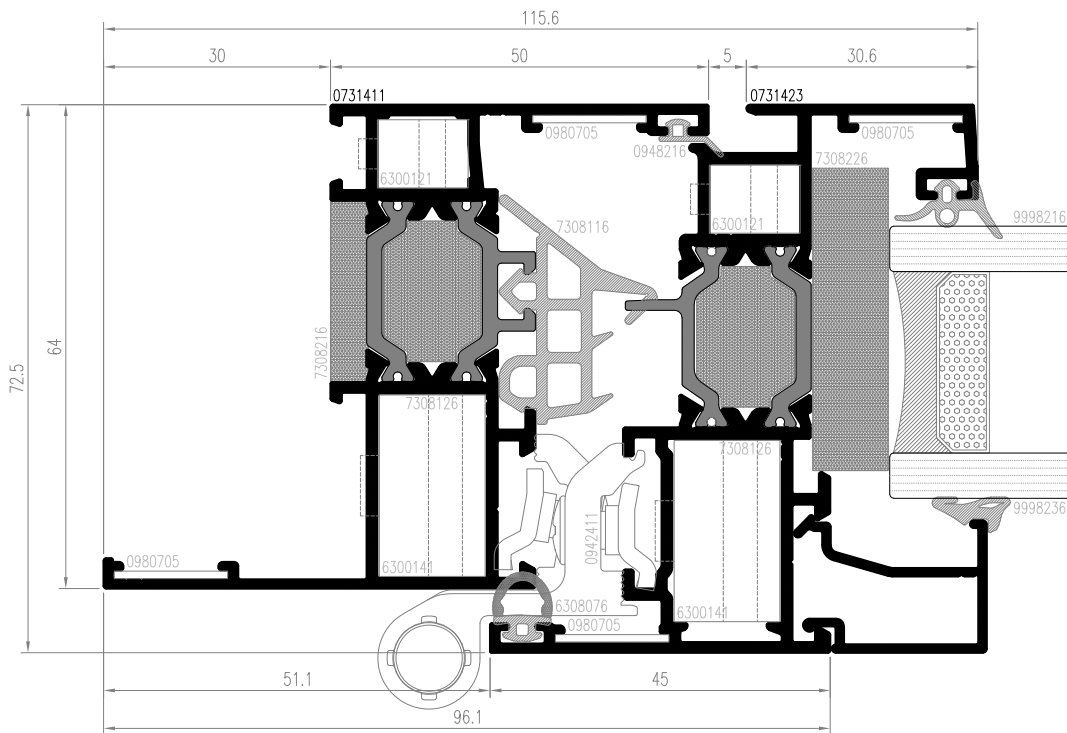

Ref.	Descripción	Ref.	Descripción
0731411	MARCO VENTANA CON SOLAPE	6308076	JUNTA HOJA
0731423	HOJA VENTANA	7308116	JUNTA CENTRAL
0942411	BISAGRA A IZQUIERDAS	7308126	AISLANTE TÉRMICO MARCO/HOJA EN POLIAMIDA
0948216	JUNTA MARCO	7308216	AISLANTE TÉRMICO MARCO EXTERIOR
0980705	ESCUADRA ALINEAMIENTO	7308226	AISLANTE TÉRMICO HOJA/VIDRIO
6300121	ESCUADRA EXTERIOR MARCO/HOJA	9998216	JUNTA ACRISTALAMIENTO EXTERIOR
6300141	ESCUADRA INTERIOR MARCO/HOJA	9998236	JUNTA ACRISTALAMIENTO 3 mm

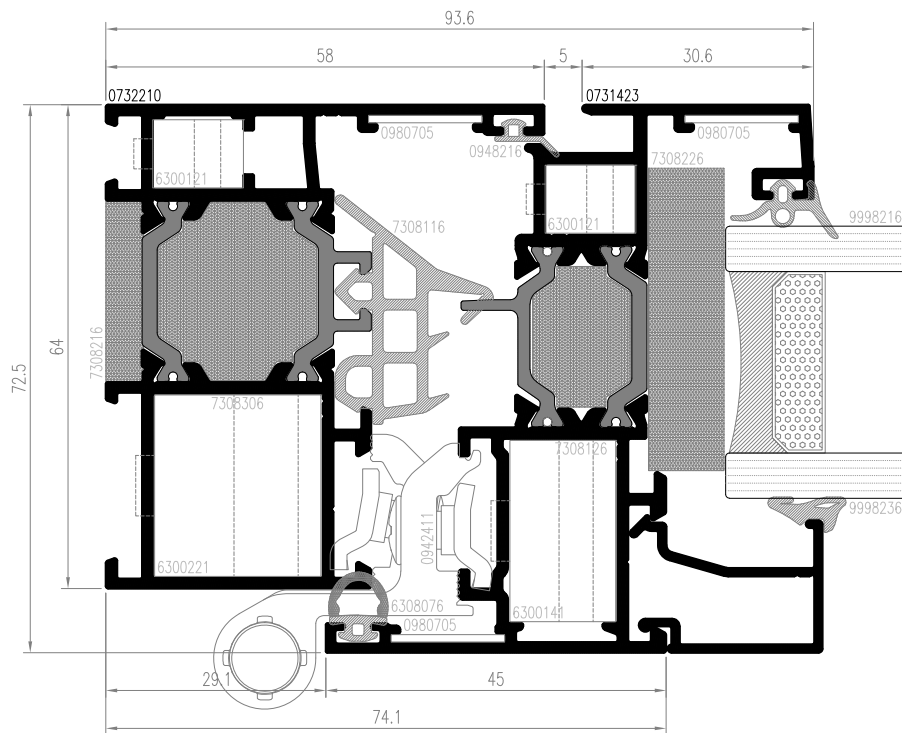

Ref.	Descripción	Ref.	Descripción
0731423	HOJA VENTANA	6308076	JUNTA HOJA
0732210	MARCO VENTANA	7308116	JUNTA CENTRAL
0942411	BISAGRA A IZQUIERDAS	7308126	AISLANTE TÉRMICO HOJA EN POLIAMIDA
0948216	JUNTA MARCO	7308216	AISLANTE TÉRMICO MARCO EXTERIOR
0980705	ESCUADRA ALINEAMIENTO	7308226	AISLANTE TÉRMICO HOJA/VIDRIO
6300121	ESCUADRA EXTERIOR MARCO/HOJA	7308306	AISLANTE TÉRMICO MARCO EN POLIAMIDA
6300141	ESCUADRA INTERIOR HOJA	9998216	JUNTA ACRISTALAMIENTO EXTERIOR
6300221	ESCUADRA INTERIOR MARCO	9998236	JUNTA ACRISTALAMIENTO 3 mm



GS-73 RT - secciones

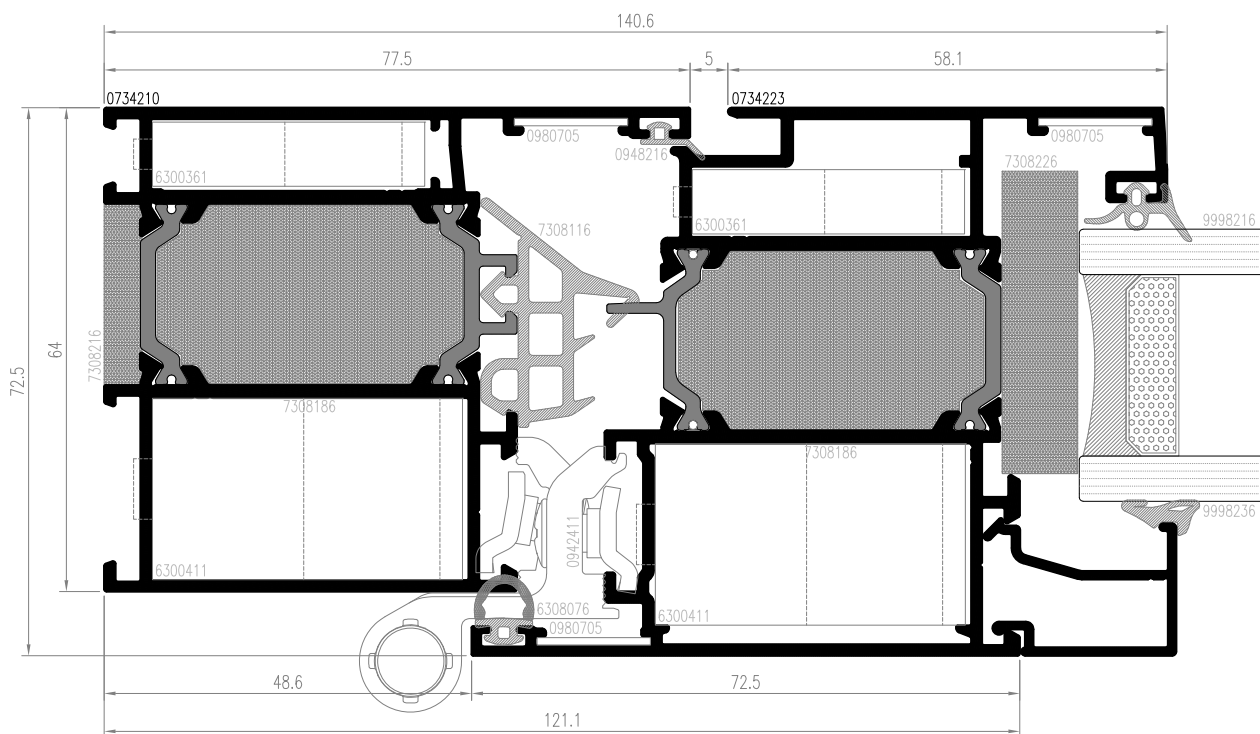

Ref.	Descripción	Ref.	Descripción
0734210	MARCO PUERTA	6308076	JUNTA HOJA
0734223	HOJA PUERTA APERTURA INTERIOR	7308116	JUNTA CENTRAL
0942411	BISAGRA A IZQUIERDAS	7308186	AISLANTE TÉRMICO MARCO/HOJA EN POLIAMIDA
0948216	JUNTA MARCO	7308216	AISLANTE TÉRMICO MARCO EXTERIOR
0980705	ESCUADRA ALINEAMIENTO	7308226	AISLANTE TÉRMICO HOJA/VIDRIO
6300361	ESCUADRA EXTERIOR MARCO/HOJA	9998216	JUNTA ACRISTALAMIENTO EXTERIOR
6300411	ESCUADRA INTERIOR MARCO/HOJA	9998236	JUNTA ACRISTALAMIENTO 3 mm

secciones - GS-73 RT

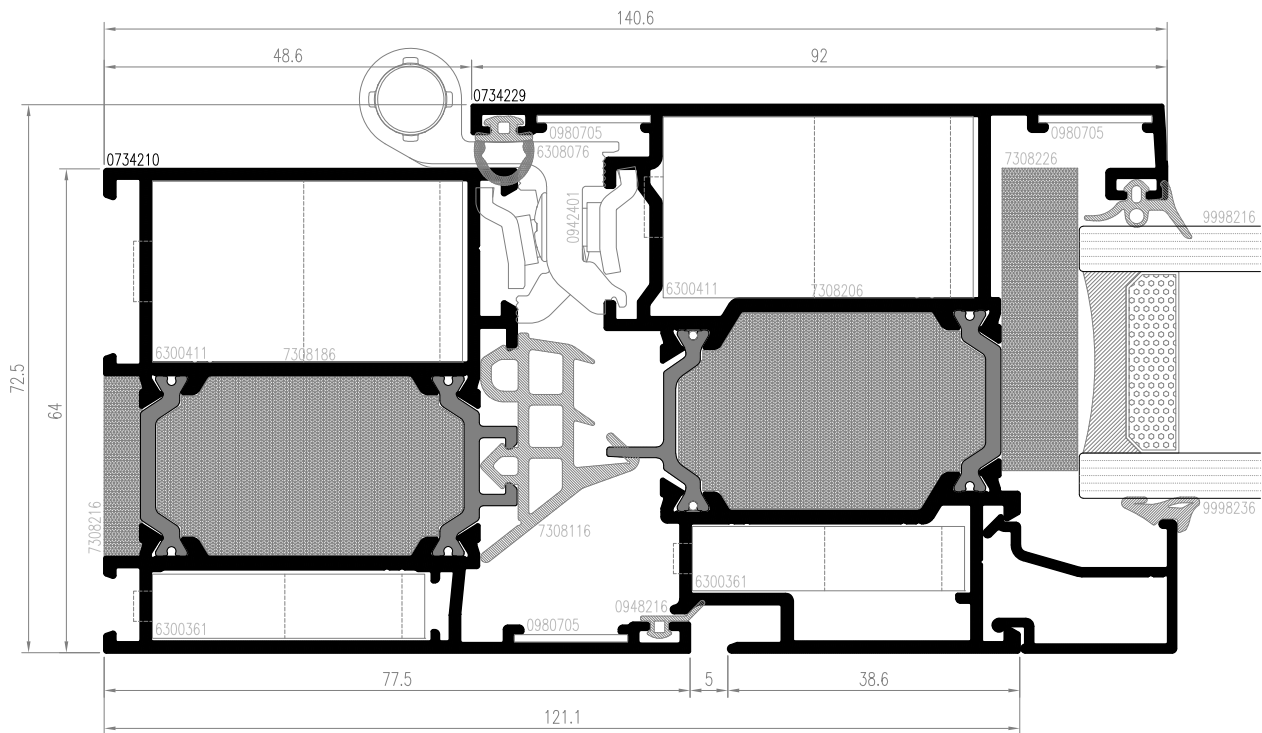

Ref.	Descripción	Ref.	Descripción
0734210	MARCO PUERTA	7308116	JUNTA CENTRAL
0734229	HOJA PUERTA APERTURA EXTERIOR	7308186	AISLANTE TÉRMICO MARCO EN POLIAMIDA
0942401	BISAGRA A IZQUIERDAS	7308206	AISLANTE TÉRMICO HOJA EN POLIAMIDA
0948216	JUNTA MARCO	7308216	AISLANTE TÉRMICO MARCO EXTERIOR
0980705	ESCUADRA ALINEAMIENTO	7308226	AISLANTE TÉRMICO HOJA/VIDRIO
6300361	ESCUADRA INTERIOR MARCO/HOJA	9998216	JUNTA ACRISTALAMIENTO EXTERIOR
6300411	ESCUADRA EXTERIOR MARCO/HOJA	9998236	JUNTA ACRISTALAMIENTO 3 mm
6308076	JUNTA HOJA		



GS-73 RT - secciones

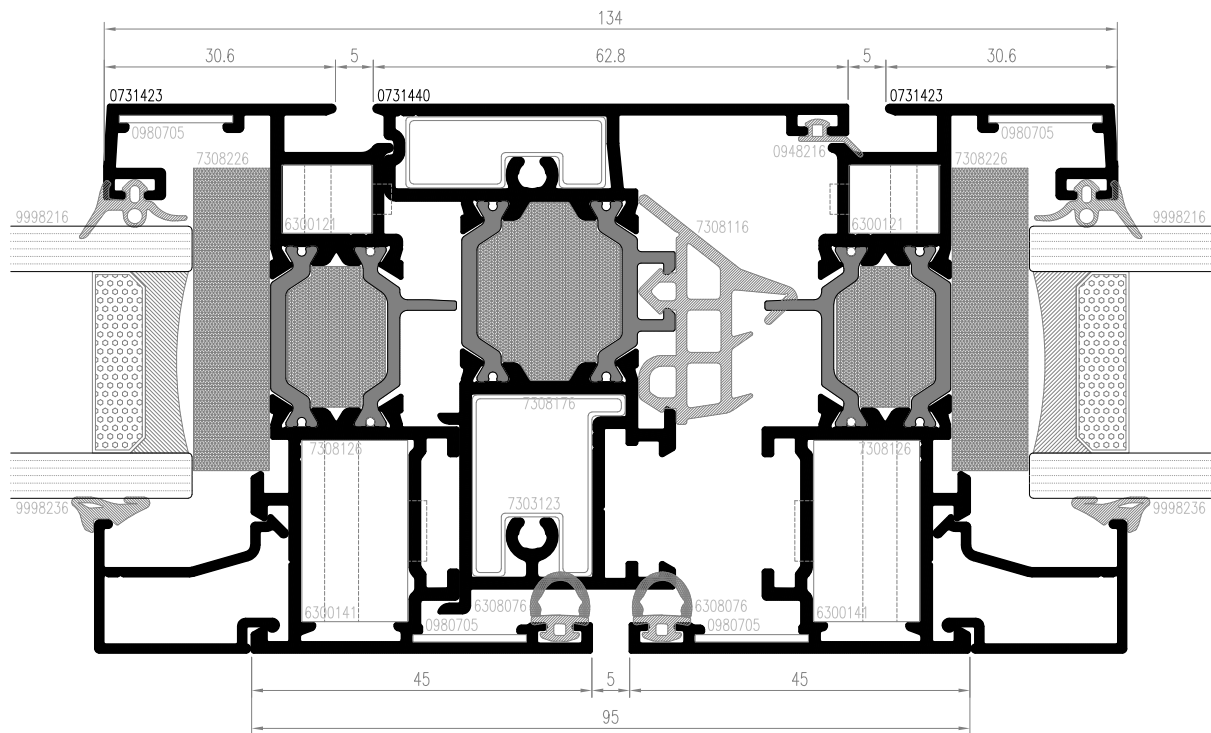

Ref.	Descripción	Ref.	Descripción
0731423	HOJA VENTANA	7303123	TAPÓN DE INVERSORA
0731440	PERFIL INVERSOR	7308116	JUNTA CENTRAL
0948216	JUNTA MARCO	7308126	AISLANTE TÉRMICO HOJA EN POLIAMIDA
0980705	ESCUADRA ALINEAMIENTO	7308176	AISLANTE TÉRMICO INVERSOR EN POLIAMIDA
6300121	ESCUADRA EXTERIOR HOJA	7308226	AISLANTE TÉRMICO HOJA/VIDRIO
6300141	ESCUADRA INTERIOR HOJA	9998216	JUNTA ACRISTALAMIENTO EXTERIOR
6308076	JUNTA HOJA	9998236	JUNTA ACRISTALAMIENTO 3 mm

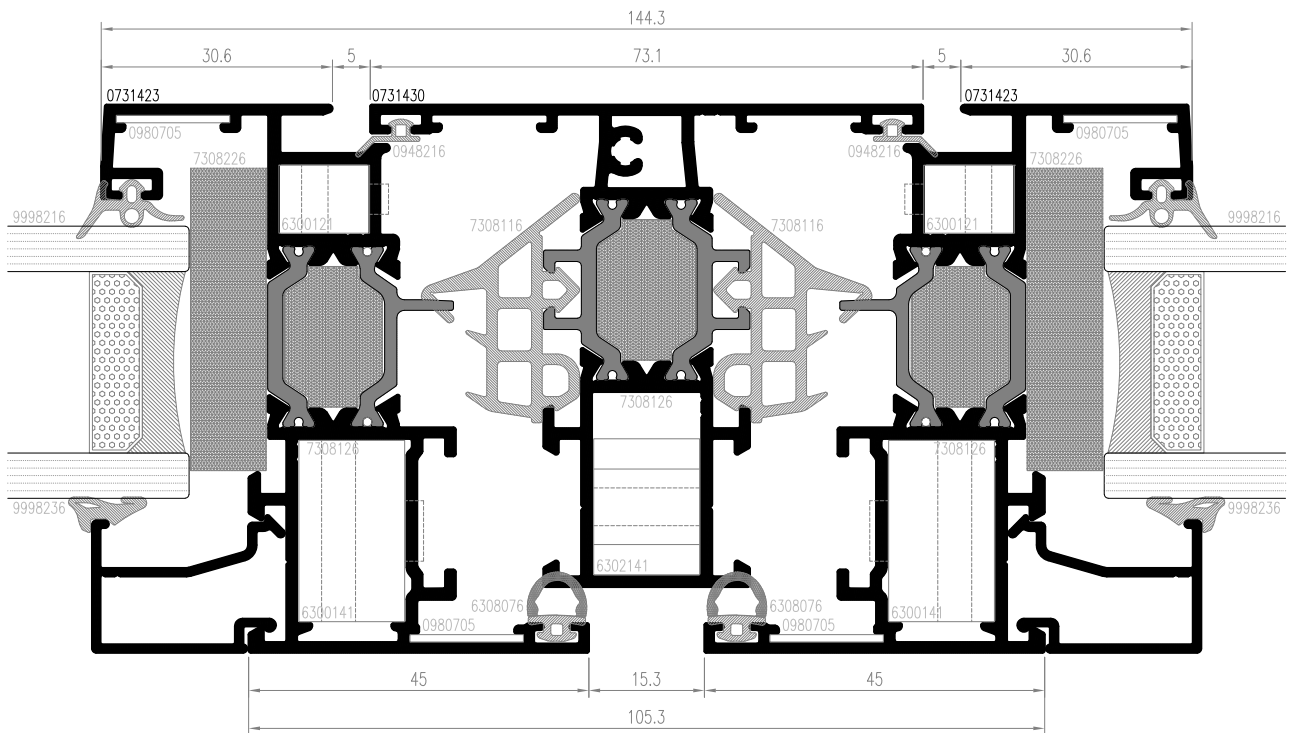

Ref.	Descripción	Ref.	Descripción
0731423	HOJA VENTANA	6308076	JUNTA HOJA
0731430	TRAVESAÑO VENTANA	7308116	JUNTA CENTRAL
0948216	JUNTA MARCO	7308126	AISLANTE TÉRMICO HOJA/TRAVESAÑO EN POLI.
0980705	ESCUADRA ALINEAMIENTO	7308226	AISLANTE TÉRMICO HOJA/VIDRIO
6300121	ESCUADRA EXTERIOR HOJA	9998216	JUNTA ACRISTALAMIENTO EXTERIOR
6300141	ESCUADRA INTERIOR HOJA	9998236	JUNTA ACRISTALAMIENTO 3 mm
6302141	UNIÓN EUROPEA TRAVESAÑO VENTANA		



GS-73 RT - secciones

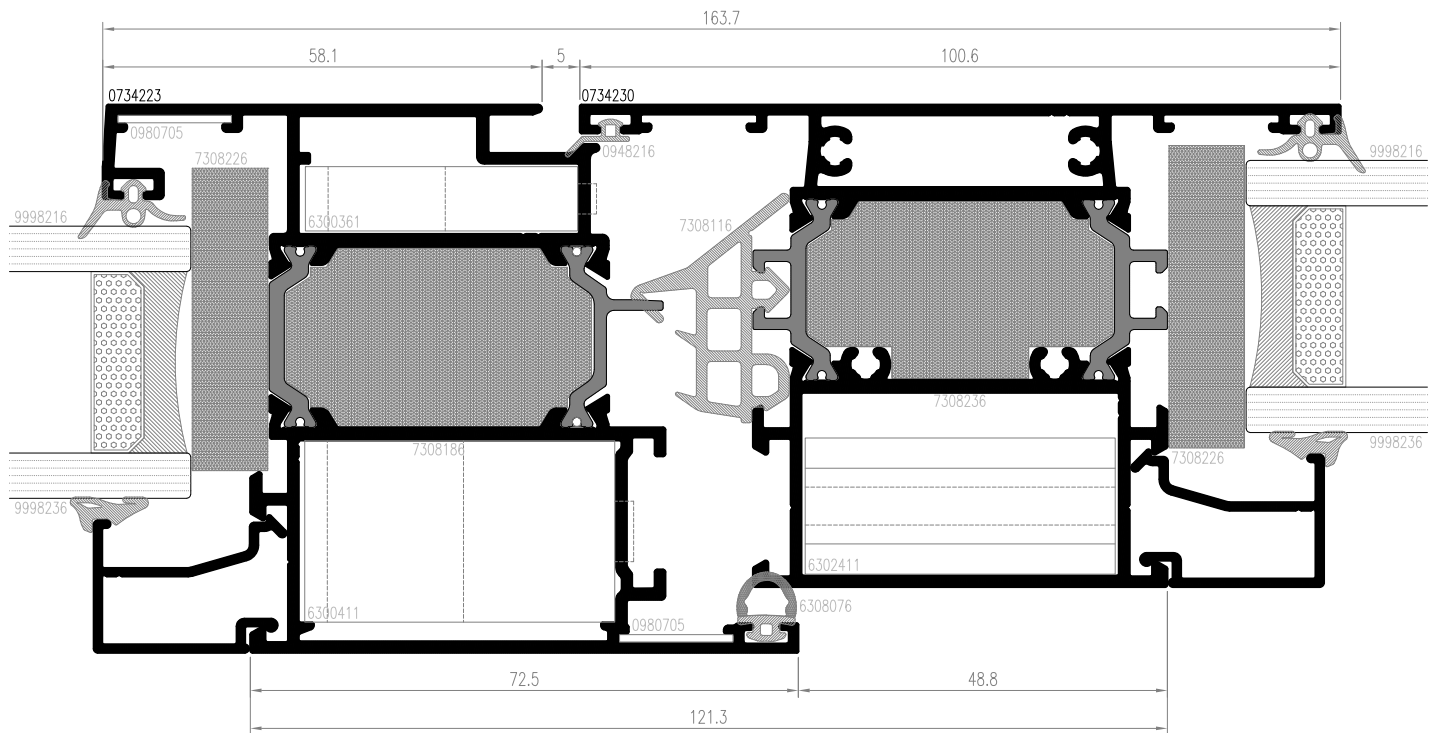

Ref.	Descripción	Ref.	Descripción
0734223	HOJA PUERTA APERTURA INTERIOR	6308076	JUNTA HOJA
0734230	TRAVESAÑO PUERTA	7308116	JUNTA CENTRAL
0948216	JUNTA MARCO	7308186	AISLANTE TÉRMICO HOJA EN POLIAMIDA
0980705	ESCUADRA ALINEAMIENTO	7308226	AISLANTE TÉRMICO HOJA/VIDRIO
6300361	ESCUADRA EXTERIOR MARCO/HOJA	7308236	AISLANTE TÉRMICO TRAVESAÑO EN POLIAMIDA
6300411	ESCUADRA INTERIOR MARCO/HOJA	9998216	JUNTA ACRISTALAMIENTO EXTERIOR
6302411	UNIÓN EUROPEA TRAVESAÑO PUERTA	9998236	JUNTA ACRISTALAMIENTO 3 mm

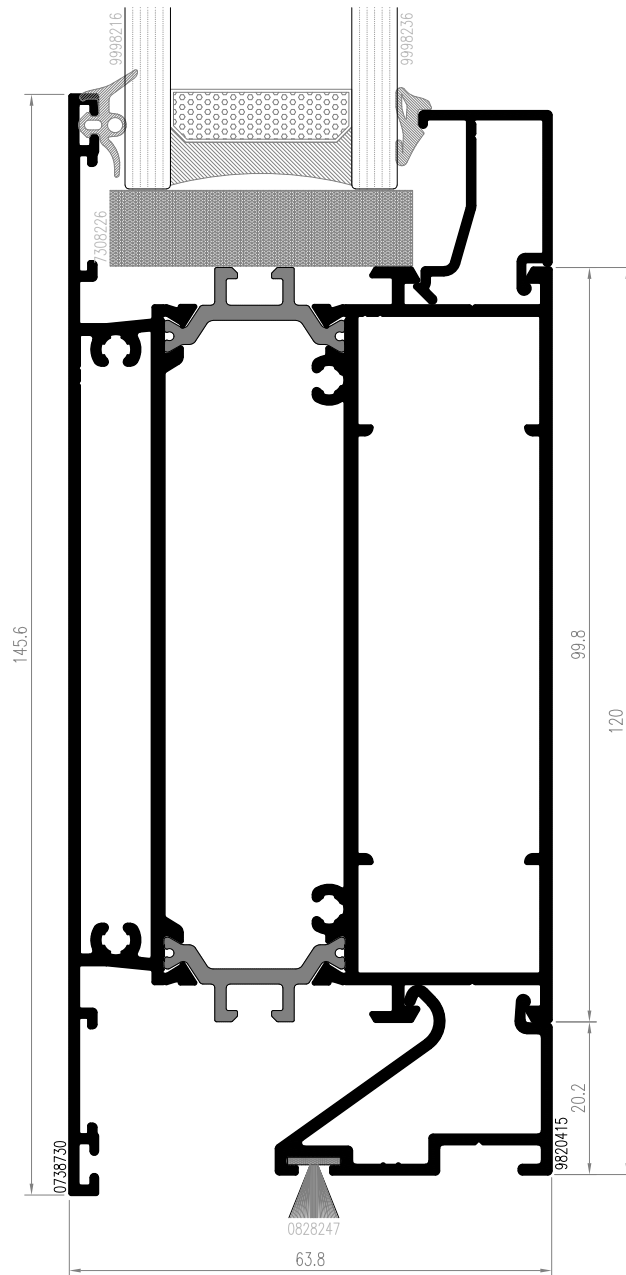

Ref.	Descripción	Ref.	Descripción
0738730	ZÓCALO	7308226	AISLANTE TÉRMICO HOJA/VIDRIO
9820415	SUPLEMENTO ZÓCALO	9998216	JUNTA ACRISTALAMIENTO EXTERIOR
0828247	FELPUDO 7x8 mm	9998236	JUNTA ACRISTALAMIENTO 3 mm



GS-73 RT - secciones

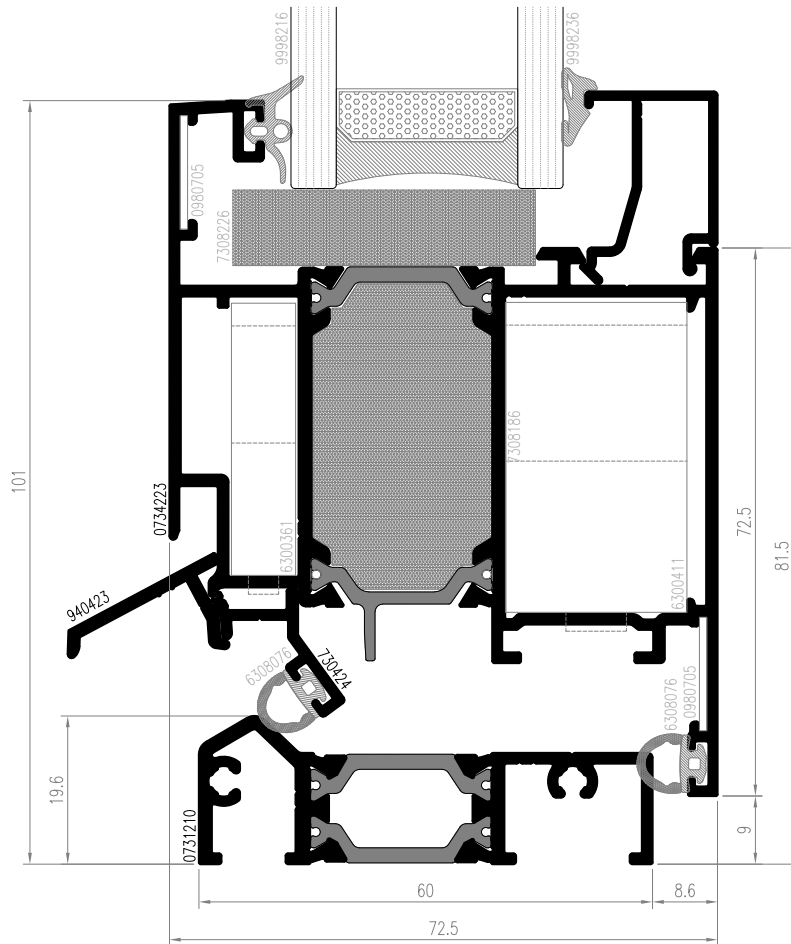

Ref.	Descripción	Ref.	Descripción
0731210	UMBRAL	6300411	ESCUADRA INTERIOR HOJA
0734223	HOJA PUERTA APERTURA INTERIOR	6308076	JUNTA HOJA
730424	SUPLEMENTO UMBRAL	7308186	AISLANTE TÉRMICO HOJA EN POLIAMIDA
940423	VIERTEAGUAS	7308226	AISLANTE TÉRMICO HOJA/VIDRIO
0980705	ESCUADRA ALINEAMIENTO	998216	JUNTA ACRISTALAMIENTO EXTERIOR
6300361	ESCUADRA EXTERIOR HOJA	998236	JUNTA ACRISTALAMIENTO 3 mm

secciones - GS-73 RT

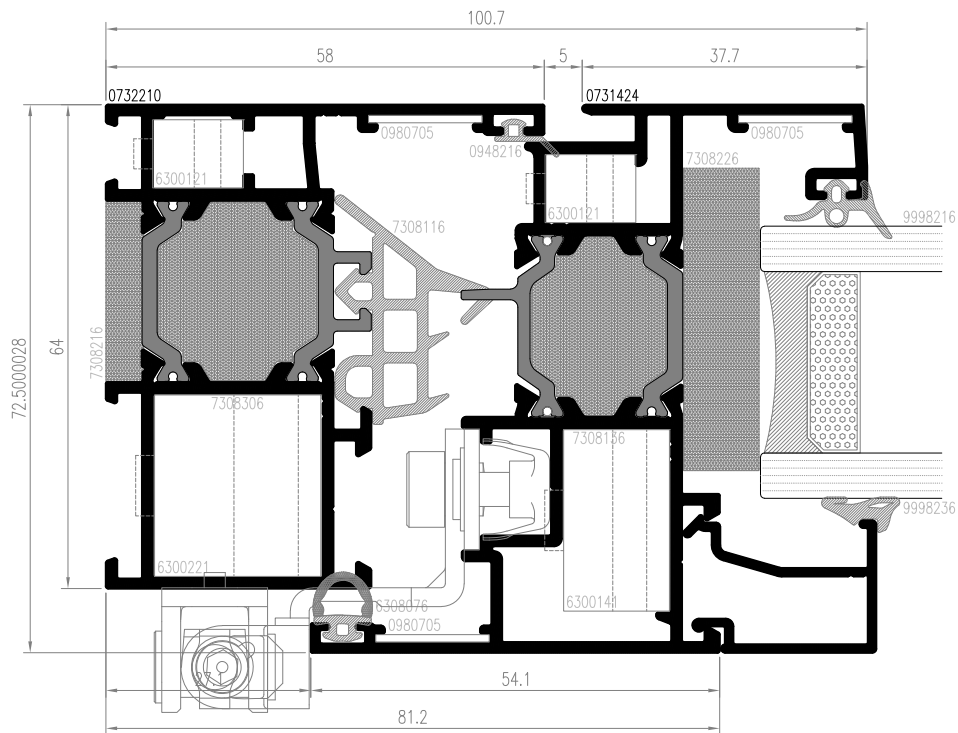

Ref.	Descripción	Ref.	Descripción
0732210	MARCO VENTANA	7308116	JUNTA CENTRAL
0731424	HOJA VENTANA CANAL 16	7308126	AISLANTE TÉRMICO HOJA EN POLIAMIDA
0948216	JUNTA MARCO	7308216	AISLANTE TÉRMICO MARCO EXTERIOR
0980705	ESCUADRA ALINEAMIENTO	7308226	AISLANTE TÉRMICO HOJA/VIDRIO
6300121	ESCUADRA EXTERIOR MARCO/HOJA	7308306	AISLANTE TÉRMICO MARCO EN POLIAMIDA
6300141	ESCUADRA INTERIOR HOJA	9998216	JUNTA ACRISTALAMIENTO EXTERIOR
6300221	ESCUADRA INTERIOR MARCO	9998236	JUNTA ACRISTALAMIENTO 3 mm
6308076	JUNTA HOJA		



GS-73 RT - secciones

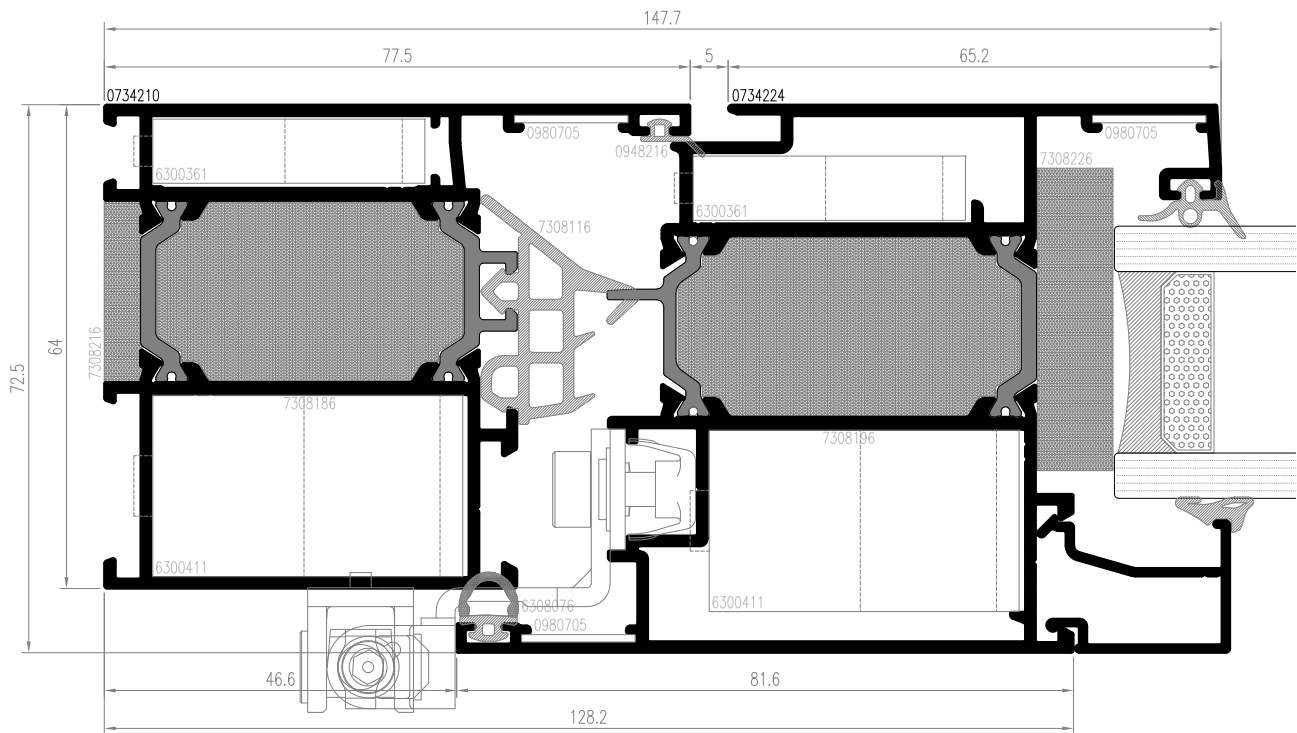

Ref.	Descripción	Ref.	Descripción
0734210	MARCO PUERTA	7308116	JUNTA CENTRAL
0734224	HOJA PUERTA CANAL 16	7308186	AISLANTE TÉRMICO MARCO EN POLIAMIDA
0948216	JUNTA MARCO	7308196	AISLANTE TÉRMICO HOJA EN POLIAMIDA
0980705	ESCUADRA ALINEAMIENTO	7308216	AISLANTE TÉRMICO MARCO EXTERIOR
6300361	ESCUADRA EXTERIOR MARCO/HOJA	7308226	AISLANTE TÉRMICO HOJA/VIDRIO
6300411	ESCUADRA INTERIOR MARCO/HOJA	9998216	JUNTA ACRISTALAMIENTO EXTERIOR
6308076	JUNTA HOJA	9998236	JUNTA ACRISTALAMIENTO 3 mm

secciones - GS-73 RT

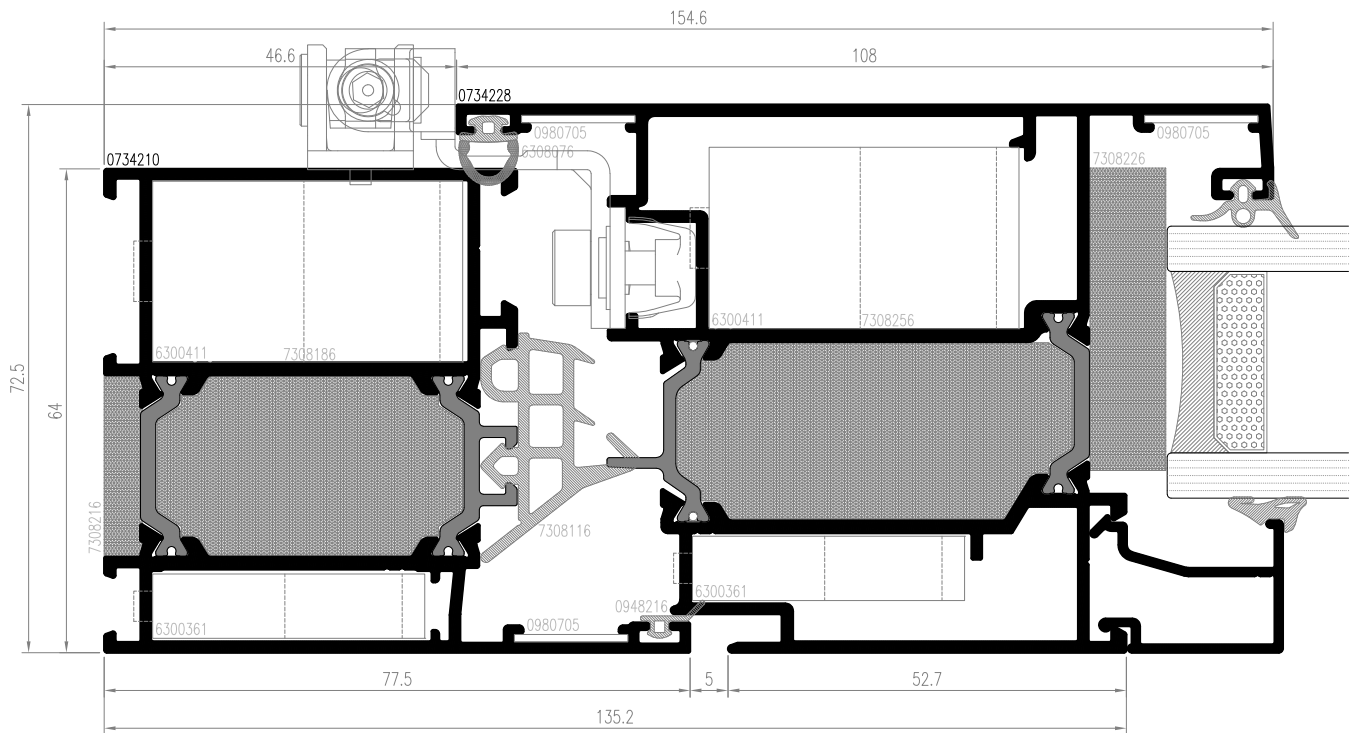

Ref.	Descripción	Ref.	Descripción
0734210	MARCO PUERTA	7308116	JUNTA CENTRAL
0734228	HOJA PUERTA APERTURA EXTERIOR CANAL 16	7308186	AISLANTE TÉRMICO MARCO EN POLIAMIDA
0948216	JUNTA MARCO	7308216	AISLANTE TÉRMICO MARCO EXTERIOR
0980705	ESCUADRA ALINEAMIENTO	7308226	AISLANTE TÉRMICO HOJA/VIDRIO
6300361	ESCUADRA INTERIOR MARCO/HOJA	7308256	AISLANTE TÉRMICO HOJA EN POLIAMIDA
6300411	ESCUADRA EXTERIOR MARCO/HOJA	9998216	JUNTA ACRISTALAMIENTO EXTERIOR
6308076	JUNTA HOJA	9998236	JUNTA ACRISTALAMIENTO 3 mm



GS-73 RT - secciones

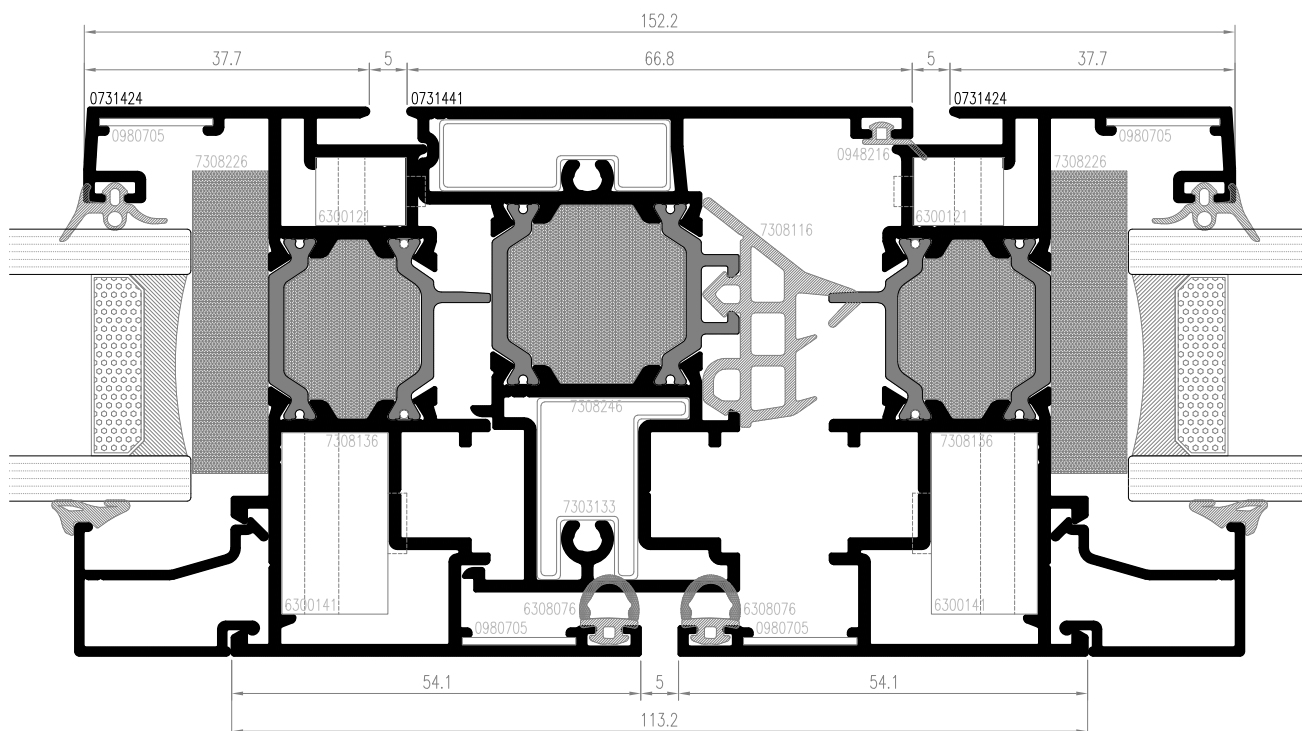

Ref.	Descripción	Ref.	Descripción
0731424	HOJA VENTANA CANAL 16	7303133	TAPÓN DE INVERSORA
0731441	PERFIL INVERSOR CANAL 16	7308116	JUNTA CENTRAL
0948216	JUNTA MARCO	7308136	AISLANTE TÉRMICO HOJA EN POLIAMIDA
0980705	ESCUADRA ALINEAMIENTO	7308226	AISLANTE TÉRMICO HOJA/VIDRIO
6300121	ESCUADRA EXTERIOR HOJA	7308246	AISLANTE TÉRMICO INVERSOR EN POLIAMIDA
6300141	ESCUADRA INTERIOR HOJA	9998216	JUNTA ACRISTALAMIENTO EXTERIOR
6308076	JUNTA HOJA	9998236	JUNTA ACRISTALAMIENTO 3 mm

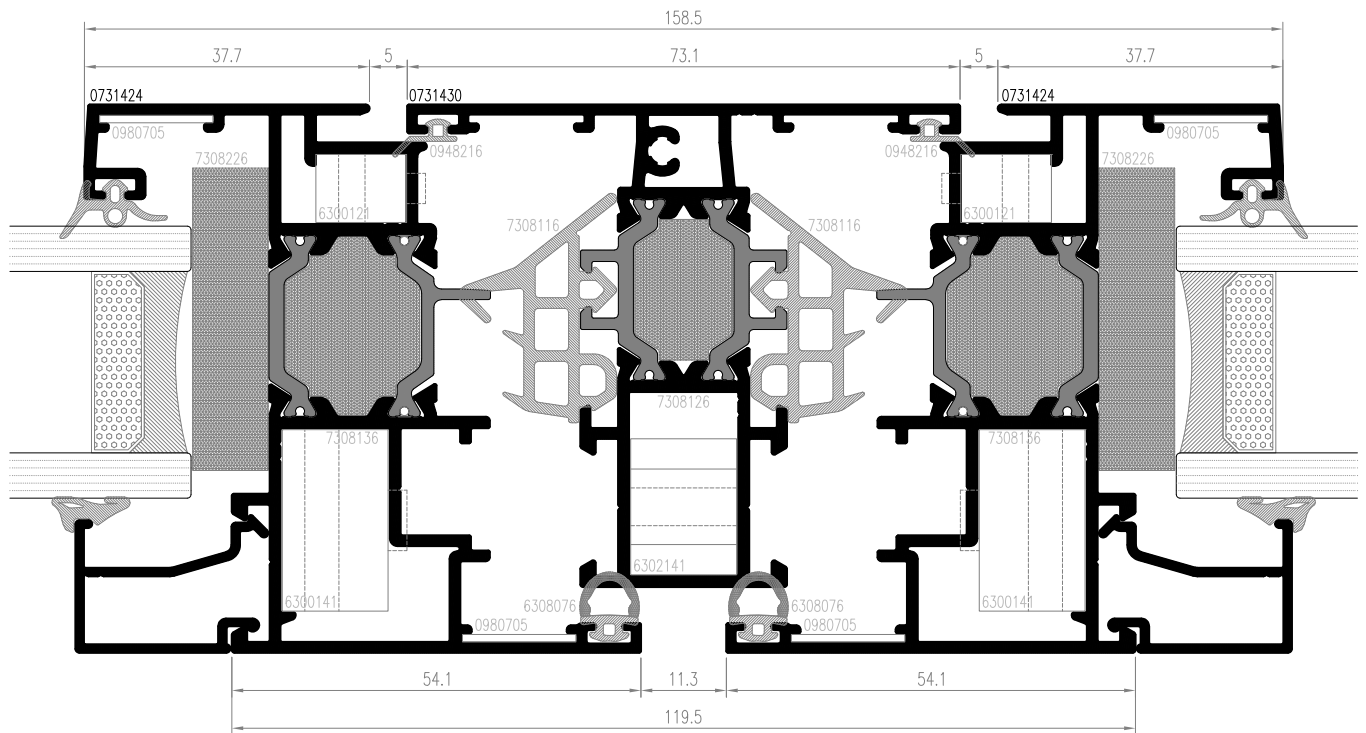

Ref.	Descripción	Ref.	Descripción
0731424	HOJA VENTANA CANAL 16	6308076	JUNTA HOJA
0731430	TRAVESAÑO VENTANA	7308116	JUNTA CENTRAL
0948216	JUNTA MARCO	7308126	AISLANTE TÉRMICO TRAVESAÑO EN POLIAMIDA
0980705	ESCUADRA ALINEAMIENTO	7308136	AISLANTE TÉRMICO HOJA EN POLIAMIDA
6300121	ESCUADRA EXTERIOR HOJA	7308226	AISLANTE TÉRMICO HOJA/VIDRIO
6300141	ESCUADRA INTERIOR HOJA	9998216	JUNTA ACRISTALAMIENTO EXTERIOR
6302141	UNIÓN EUROPEA TRAVESAÑO VENTANA	9998236	JUNTA ACRISTALAMIENTO 3 mm



GS-73 RT - secciones

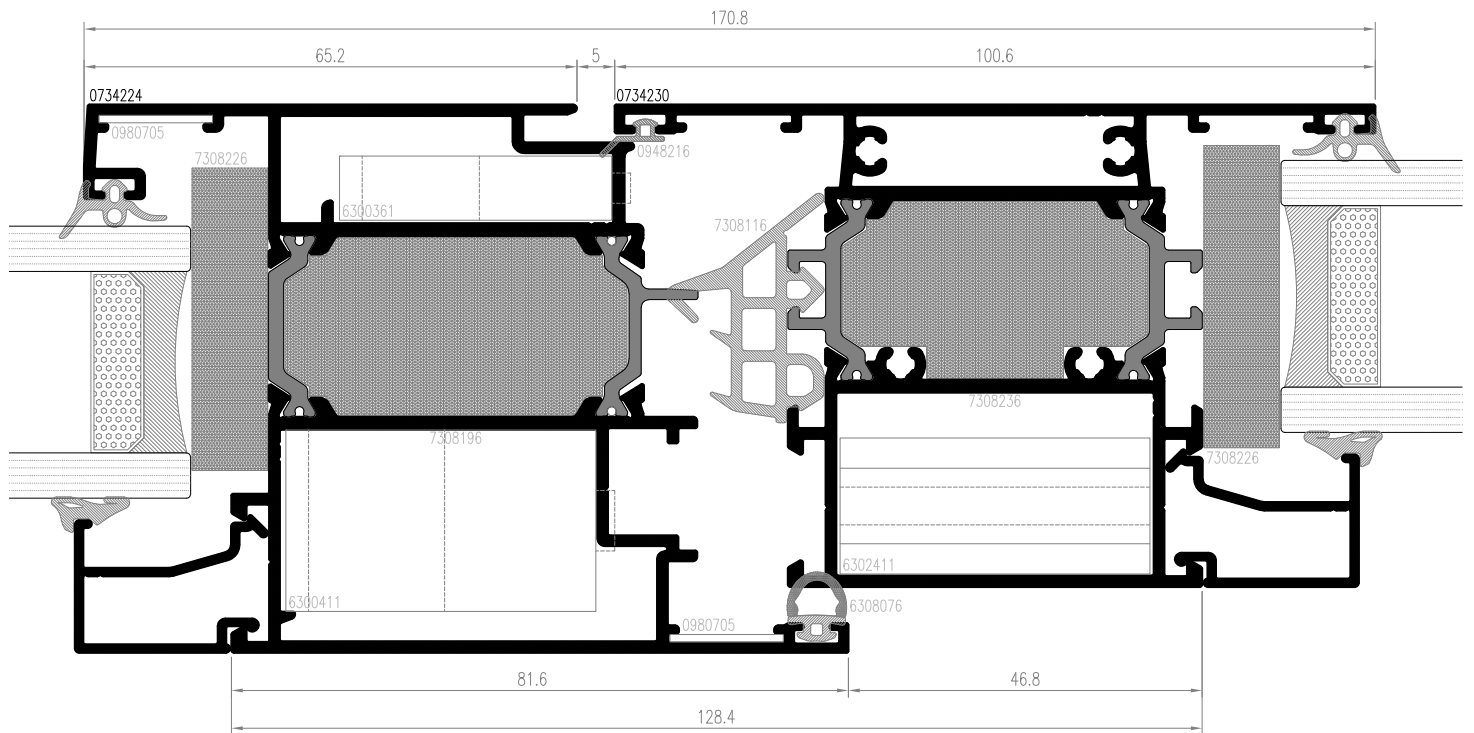

Ref.	Descripción	Ref.	Descripción
0734224	HOJA PUERTA APERTURA INTERIOR CANAL 16	6308076	JUNTA HOJA
0734230	TRAVESAÑO PUERTA	7308116	JUNTA CENTRAL
0948216	JUNTA MARCO	7308196	AISLANTE TÉRMICO HOJA EN POLIAMIDA
0980705	ESCUADRA ALINEAMIENTO	7308226	AISLANTE TÉRMICO HOJA/VIDRIO
6300361	ESCUADRA EXTERIOR HOJA	7308236	AISLANTE TÉRMICO TRAVESAÑO EN POLIAMIDA
6300411	ESCUADRA INTERIOR HOJA	9998216	JUNTA ACRISTALAMIENTO EXTERIOR
6302411	UNIÓN EUROPEA TRAVESAÑO PUERTA	9998236	JUNTA ACRISTALAMIENTO 3 mm



GS-73 RT

PRACTICABLE CON
ROTURA DE PUENTE TÉRMICO

■ HOJAS DE CORTE

HOJAS DE CORTE



GS-73 RT - hojas de corte

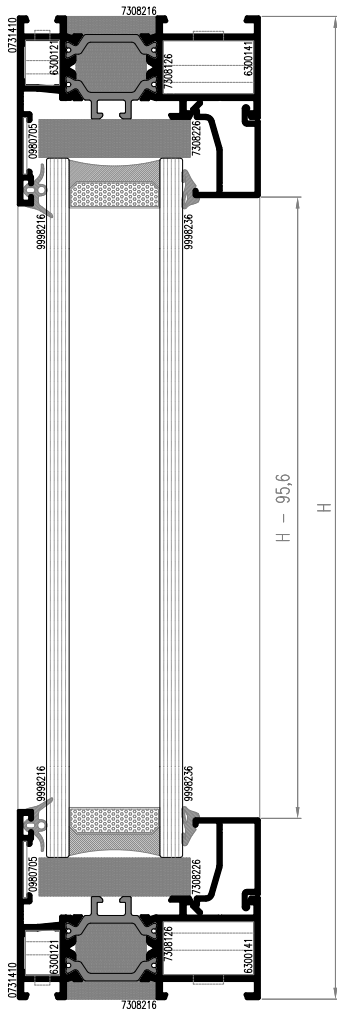

Referencia	Descripción	Cantidad	Medida	Posición	Grados
0731410	MARCO VENTANA	2	L	Horizontal	45°
0731410	MARCO VENTANA	2	H	Vertical	45°
***	JUNQUILLO	2	L - 54,6	Horizontal	90°
***	JUNQUILLO	2	H - 95,6	Vertical	90°
0980705	ESCUADRA ALINEAMIENTO	4			
6300121	ESCUADRA EXTERIOR MARCO	4			
6300141	ESCUADRA INTERIOR MARCO	4			
7308126	AISLANTE TÉRMICO MARCO EN POLIAMIDA	$L^*2 + H^*2$			
7308216	AISLANTE TÉRMICO MARCO EXTERIOR	$L^*2 + H^*2$			
7308226	AISLANTE TÉRMICO MARCO/VIDRIO	$L^*2 + H^*2$			
9998216	JUNTA ACRISTALAMIENTO EXTERIOR	$L^*2 + H^*2$			
9998236	JUNTA ACRISTALAMIENTO 3 mm	$L^*2 + H^*2$			

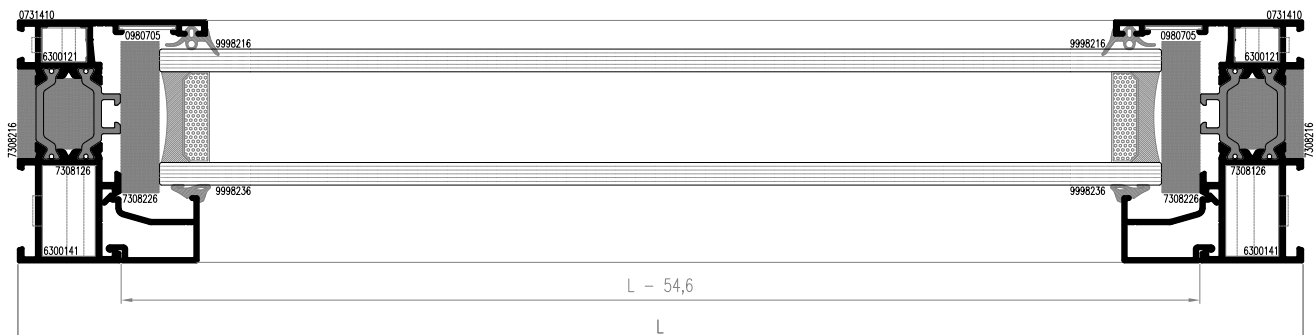
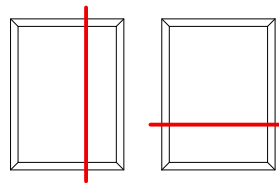

GS-73 RT - hojas de corte

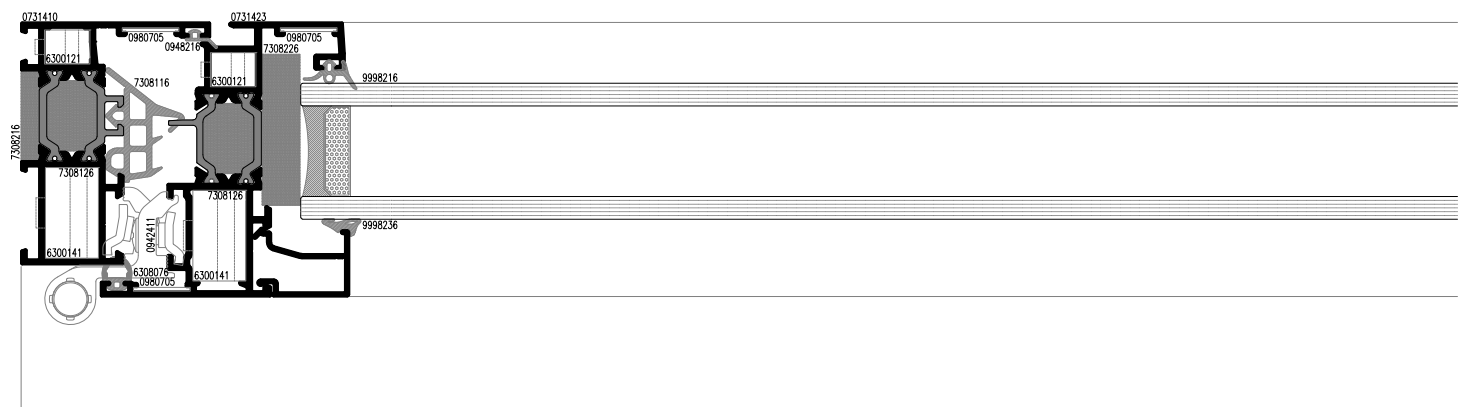
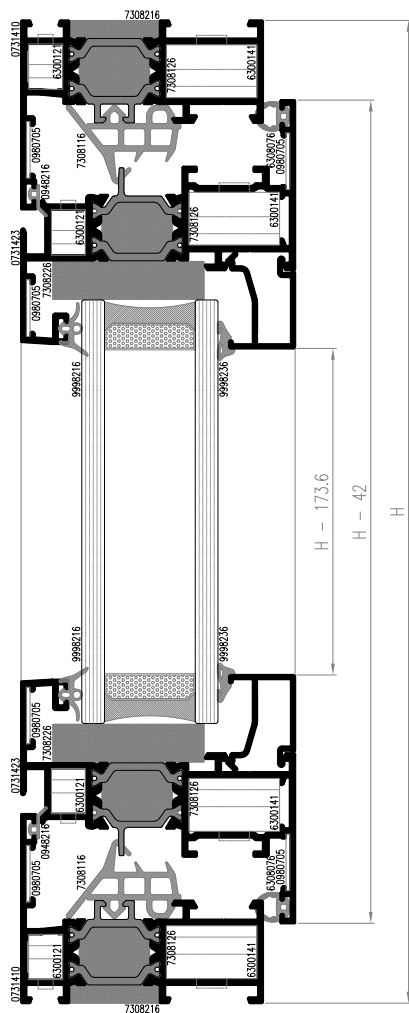

hojas de corte - GS-73 RT

Referencia	Descripción	Cantidad	Medida	Posición	Grados
0731410	MARCO VENTANA	2	L	Horizontal	45°
0731410	MARCO VENTANA	2	H	Vertical	45°
0731423	HOJA VENTANA	2	L/2 - 23,5	Horizontal	45°
0731423	HOJA VENTANA	4	H - 42	Vertical	45°
0731440	PERFIL INVERSOR	1	H - 124	Vertical	90°
***	JUNQUILLO	2	L/2 - 114	Horizontal	90°
***	JUNQUILLO	4	H - 173,6	Vertical	90°
0942411	BISAGRA A IZQUIERDAS	2			
0942401	BISAGRA A DERECHAS	2			
0948216	JUNTA MARCO	L*2 + H*3			
0980705	ESCUADRA ALINEAMIENTO	20			
6300121	ESCUADRA EXTERIOR MARCO/HOJA	12			
6300141	ESCUADRA INTERIOR MARCO/HOJA	12			
6308076	JUNTA HOJA	L*2 + H*4			
7303123	TAPÓN DE INVERSORA	1			
7308116	JUNTA CENTRAL	L*2 + H*3			
7308126	AISLANTE TÉRMICO MARCO/HOJA EN POLIAM.	L*4 + H*6			
7308176	AISLANTE TÉRMICO INVERSOR EN POLIAMIDA	H			
7308216	AISLANTE TÉRMICO MARCO EXTERIOR	L*2 + H*2			
7308226	AISLANTE TÉRMICO HOJA/VIDRIO	L*2 + H*4			
9998216	JUNTA ACRISTALAMIENTO EXTERIOR	L*2 + H*4			
9998236	JUNTA ACRISTALAMIENTO 3 mm	L*2 + H*4			

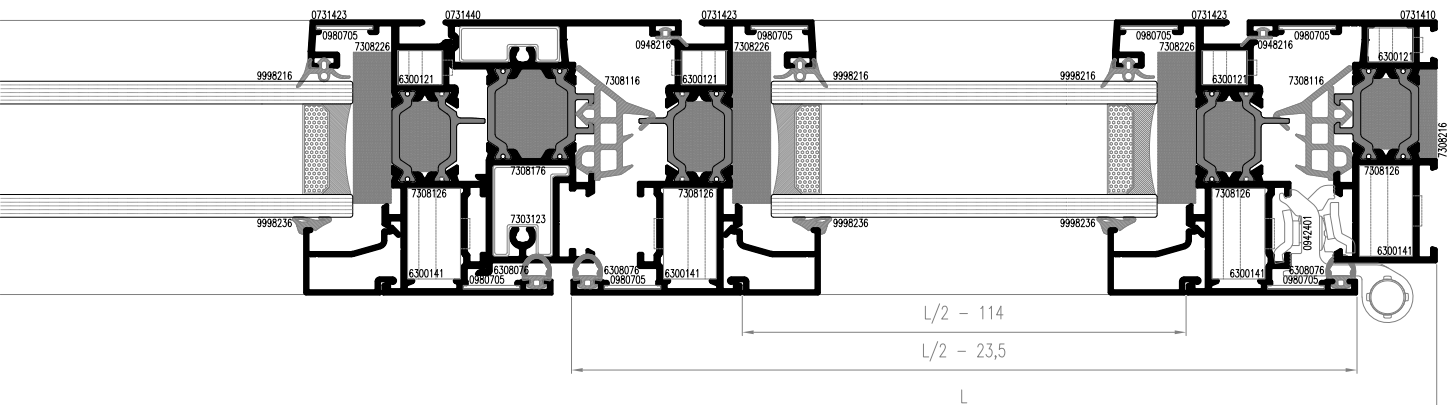
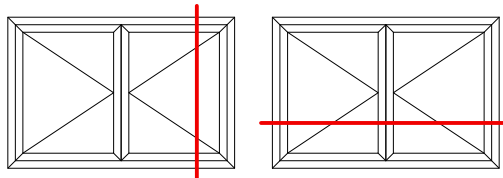

GS-73 RT - hojas de corte

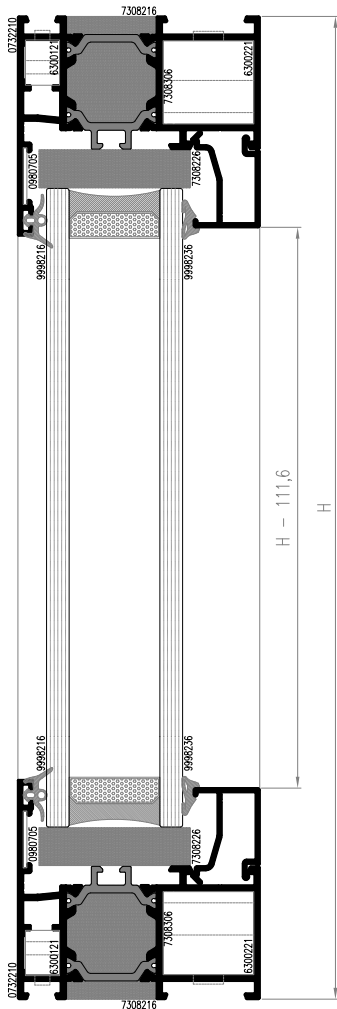

Referencia	Descripción	Cantidad	Medida	Posición	Grados
0732210	MARCO VENTANA	2	L	Horizontal	45°
0732210	MARCO VENTANA	2	H	Vertical	45°
***	JUNQUILLO	2	L - 70,6	Horizontal	90°
***	JUNQUILLO	2	H - 111,6	Vertical	90°
0980705	ESCUADRA ALINEAMIENTO	4			
6300121	ESCUADRA EXTERIOR MARCO	4			
6300221	ESCUADRA INTERIOR MARCO	4			
7308216	AISLANTE TÉRMICO MARCO EXTERIOR	$L^*2 + H^*2$			
7308226	AISLANTE TÉRMICO MARCO/VIDRIO	$L^*2 + H^*2$			
7308306	AISLANTE TÉRMICO MARCO EN POLIAMIDA	$L^*2 + H^*2$			
9998216	JUNTA ACRISTALAMIENTO EXTERIOR	$L^*2 + H^*2$			
9998236	JUNTA ACRISTALAMIENTO 3 mm	$L^*2 + H^*2$			

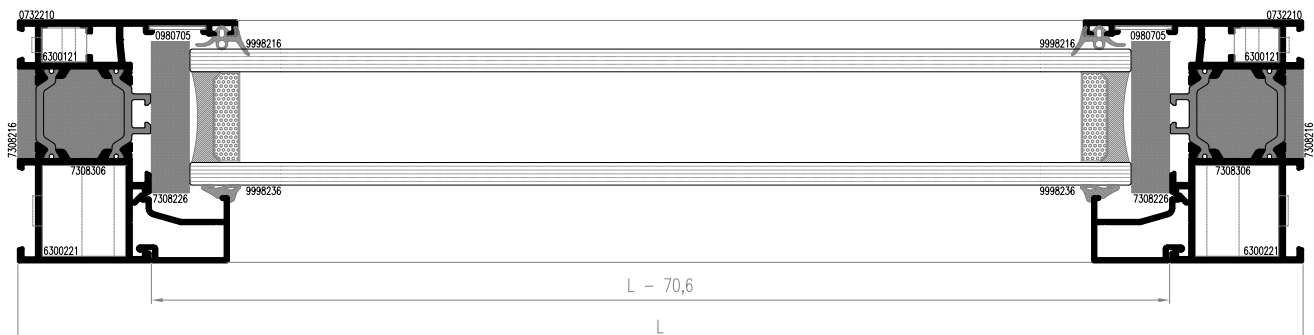
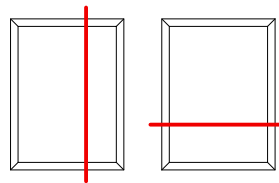

hojas de corte - GS-73 RT

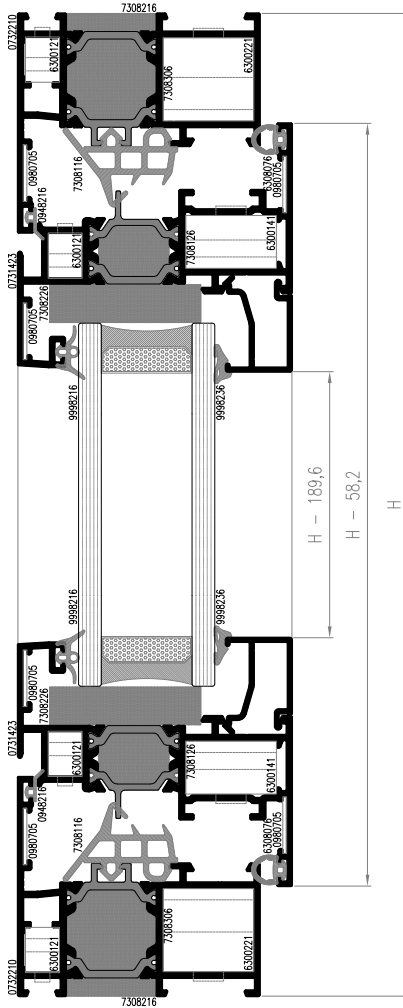

Referencia	Descripción	Cantidad	Medida	Posición	Grados
0732210	MARCO VENTANA	2	L	Horizontal	45°
0732210	MARCO VENTANA	2	H	Vertical	45°
0731423	HOJA VENTANA	2	L - 58,2	Horizontal	45°
0731423	HOJA VENTANA	2	H - 58,2	Vertical	45°
***	JUNQUILLO	2	L - 148,6	Horizontal	90°
***	JUNQUILLO	2	H - 189,6	Vertical	90°
0942411	BISAGRA A IZQUIERDAS	2			
0948216	JUNTA MARCO	L*2 + H*2			
0980705	ESCUADRA ALINEAMIENTO	12			
6300121	ESCUADRA EXTERIOR MARCO/HOJA	8			
6300141	ESCUADRA INTERIOR HOJA	4			
6300221	ESCUADRA INTERIOR MARCO	4			
6308076	JUNTA HOJA	L*2 + H*2			
7308116	JUNTA CENTRAL	L*2 + H*2			
7308126	AISLANTE TÉRMICO HOJA EN POLIAMIDA	L*2 + H*2			
7308216	AISLANTE TÉRMICO MARCO EXTERIOR	L*2 + H*2			
7308226	AISLANTE TÉRMICO HOJA/VIDRIO	L*2 + H*2			
7308306	AISLANTE TÉRMICO MARCO EN POLIAMIDA	L*2 + H*2			
9998216	JUNTA ACRISTALAMIENTO EXTERIOR	L*2 + H*2			
9998236	JUNTA ACRISTALAMIENTO 3 mm	L*2 + H*2			

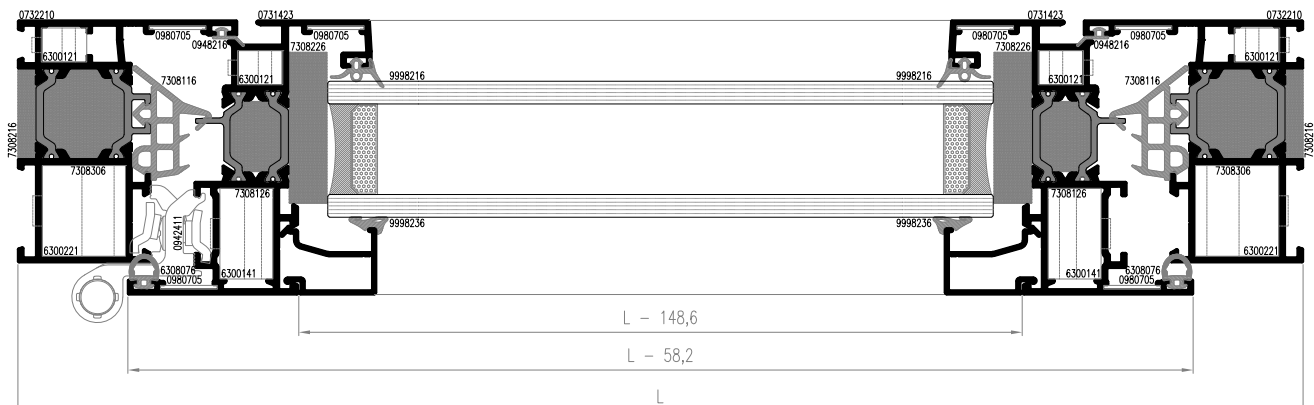
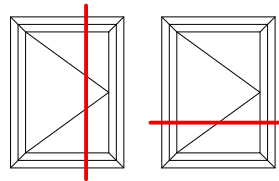

GS-73 RT - hojas de corte

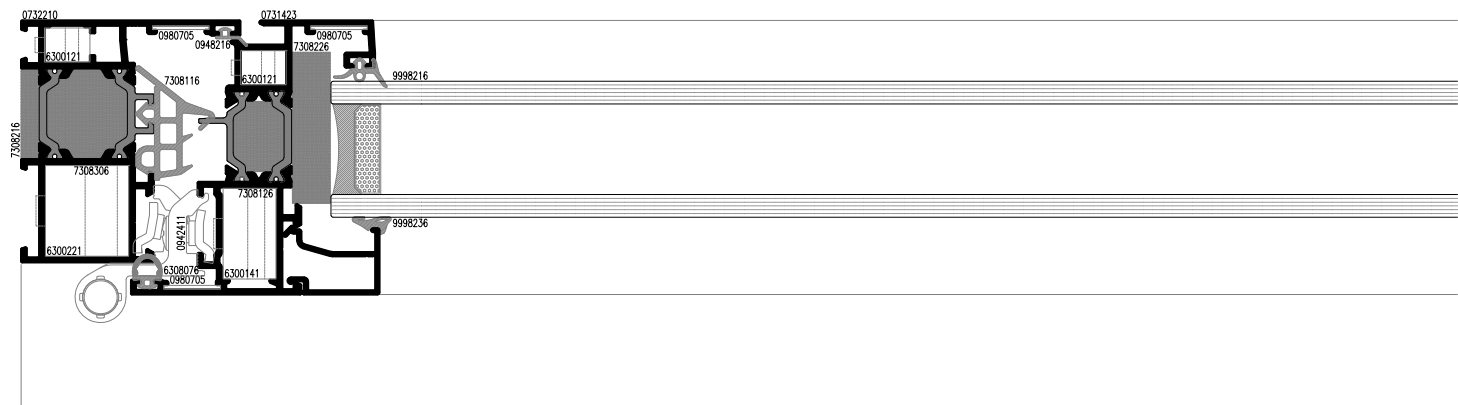
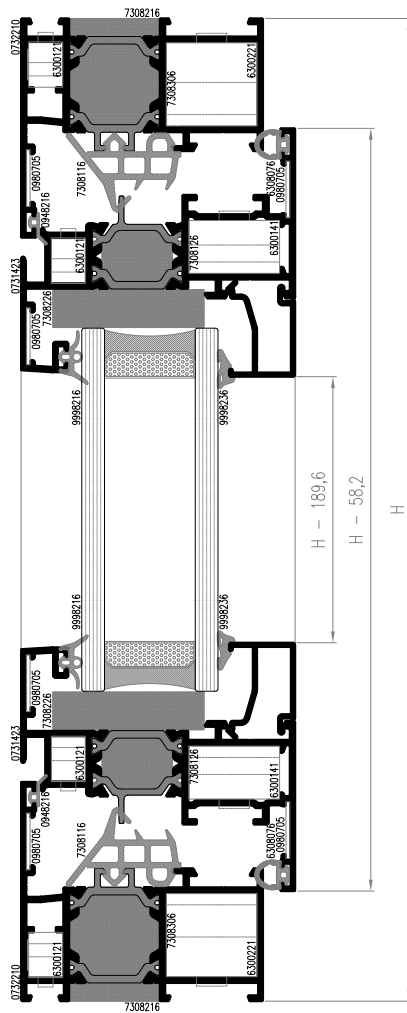

hojas de corte - GS-73 RT

Referencia	Descripción	Cantidad	Medida	Posición	Grados
0732210	MARCO VENTANA	2	L	Horizontal	45°
0732210	MARCO VENTANA	2	H	Vertical	45°
0731423	HOJA VENTANA	2	L/2 - 31,6	Horizontal	45°
0731423	HOJA VENTANA	4	H - 58,2	Vertical	45°
0731440	PERFIL INVERSOR	1	H - 140	Vertical	90°
***	JUNQUILLO	2	L/2 - 122	Horizontal	90°
***	JUNQUILLO	4	H - 189,6	Vertical	90°
0942411	BISAGRA A IZQUIERDAS	2			
0942401	BISAGRA A DERECHAS	2			
0948216	JUNTA MARCO	L*2 + H*3			
0980705	ESCUADRA ALINEAMIENTO	20			
6300121	ESCUADRA EXTERIOR MARCO/HOJA	12			
6300141	ESCUADRA INTERIOR HOJA	8			
6300221	ESCUADRA INTERIOR MARCO	4			
6308076	JUNTA HOJA	L*2 + H*4			
7303123	TAPÓN DE INVERSORA	1			
7308116	JUNTA CENTRAL	L*2 + H*3			
7308126	AISLANTE TÉRMICO HOJA EN POLIAMIDA	L*2 + H*4			
7308176	AISLANTE TÉRMICO INVERSOR EN POLIAMIDA	H			
7308216	AISLANTE TÉRMICO MARCO EXTERIOR	L*2 + H*2			
7308226	AISLANTE TÉRMICO HOJA/VIDRIO	L*2 + H*4			
7308306	AISLANTE TÉRMICO MARCO EN POLIAMIDA	L*2 + H*2			
9998216	JUNTA ACRISTALAMIENTO EXTERIOR	L*2 + H*4			
9998236	JUNTA ACRISTALAMIENTO 3 mm	L*2 + H*4			

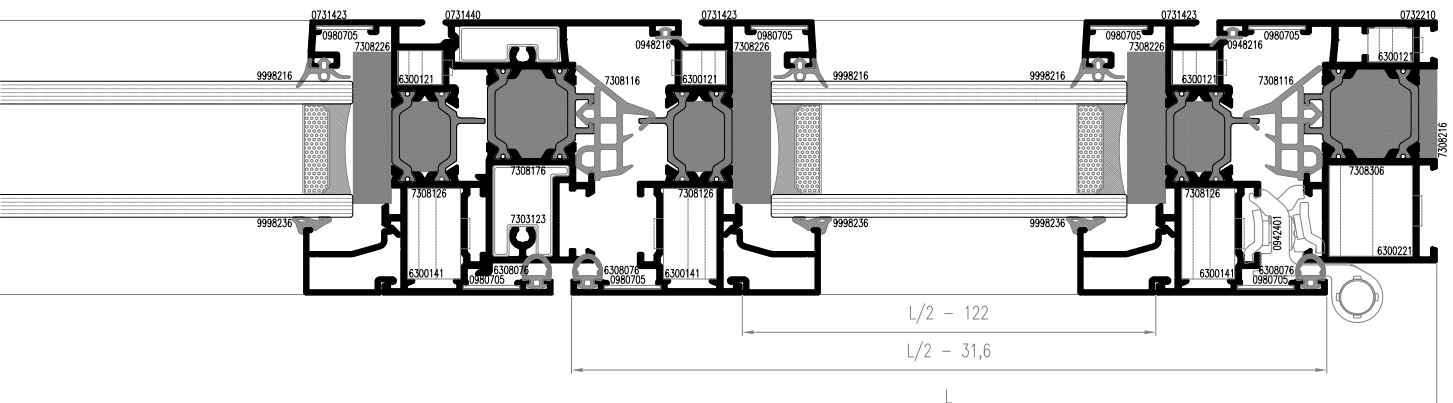
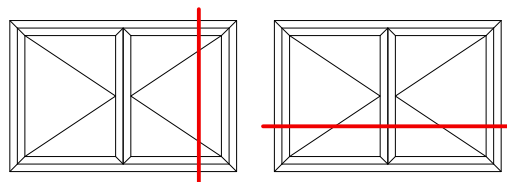

GS-73 RT - hojas de corte

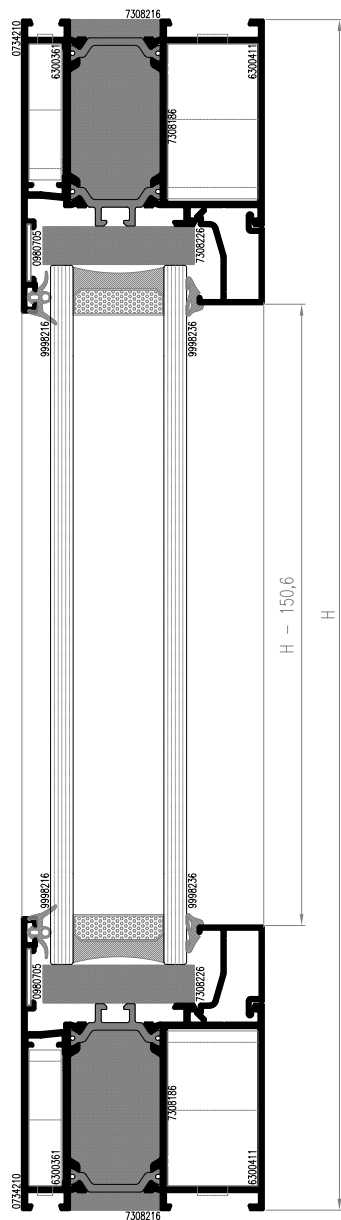

Referencia	Descripción	Cantidad	Medida	Posición	Grados
0734210	MARCO PUERTA	2	L	Horizontal	45°
0734210	MARCO PUERTA	2	H	Vertical	45°
***	JUNQUILLO	2	L - 109,6	Horizontal	90°
***	JUNQUILLO	2	H - 150,6	Vertical	90°
0980705	ESCUADRA ALINEAMIENTO	4			
6300361	ESCUADRA EXTERIOR MARCO	4			
6300411	ESCUADRA INTERIOR MARCO	4			
7308186	AISLANTE TÉRMICO MARCO EN POLIAMIDA	$L^*2 + H^*2$			
7308216	AISLANTE TÉRMICO MARCO EXTERIOR	$L^*2 + H^*2$			
7308226	AISLANTE TÉRMICO MARCO/VIDRIO	$L^*2 + H^*2$			
9998216	JUNTA ACRISTALAMIENTO EXTERIOR	$L^*2 + H^*2$			
9998236	JUNTA ACRISTALAMIENTO 3 mm	$L^*2 + H^*2$			

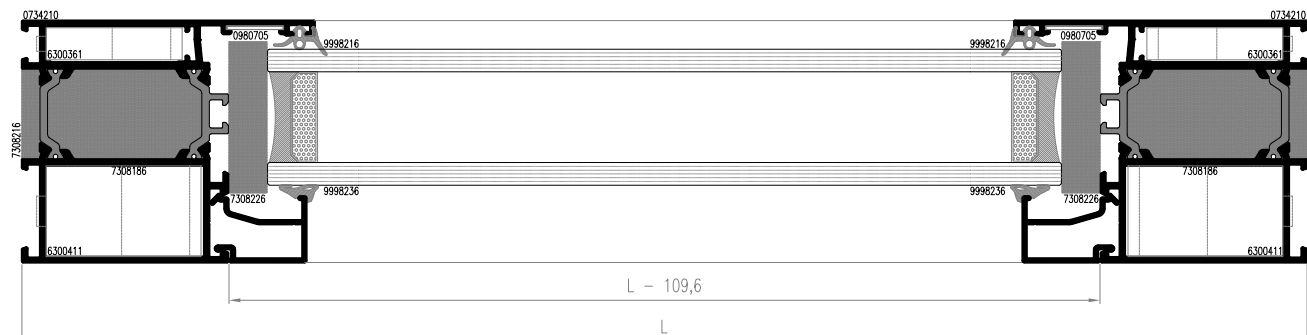
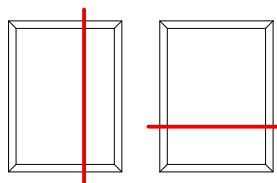

hojas de corte - GS-73 RT

Referencia	Descripción	Cantidad	Medida	Posición	Grados
0734210	MARCO PUERTA	2	L	Horizontal	45°
0734210	MARCO PUERTA	2	H	Vertical	45°
0734223	HOJA PUERTA	2	L/2 - 51,1	Horizontal	45°
0734223	HOJA PUERTA	4	H - 97,2	Vertical	45°
0731440	PERFIL INVERSOR	1	H - 175	Vertical	90°
***	JUNQUILLO	2	L/2 - 196,5	Horizontal	90°
***	JUNQUILLO	4	H - 283,6	Vertical	90°
0942411	BISAGRA A IZQUIERDAS	2			
0942401	BISAGRA A DERECHAS	2			
0948216	JUNTA MARCO	L*2 + H*3			
0980705	ESCUADRA ALINEAMIENTO	20			
6300121	ESCUADRA EXTERIOR MARCO/HOJA	12			
6300141	ESCUADRA INTERIOR MARCO/HOJA	12			
6308076	JUNTA HOJA	L*2 + H*4			
7303123	TAPÓN DE INVERSORA	1			
7308116	JUNTA CENTRAL	L*2 + H*3			
7308176	AISLANTE TÉRMICO INVERSOR EN POLIAMIDA	H			
7308186	AISLANTE TÉRMICO MARCO/HOJA EN POLIAMIDA	L*4 + H*6			
7308216	AISLANTE TÉRMICO MARCO EXTERIOR	L*2 + H*2			
7308226	AISLANTE TÉRMICO HOJA/VIDRIO	L*2 + H*4			
9998216	JUNTA ACRISTALAMIENTO EXTERIOR	L*2 + H*4			
9998236	JUNTA ACRISTALAMIENTO 3 mm	L*2 + H*4			

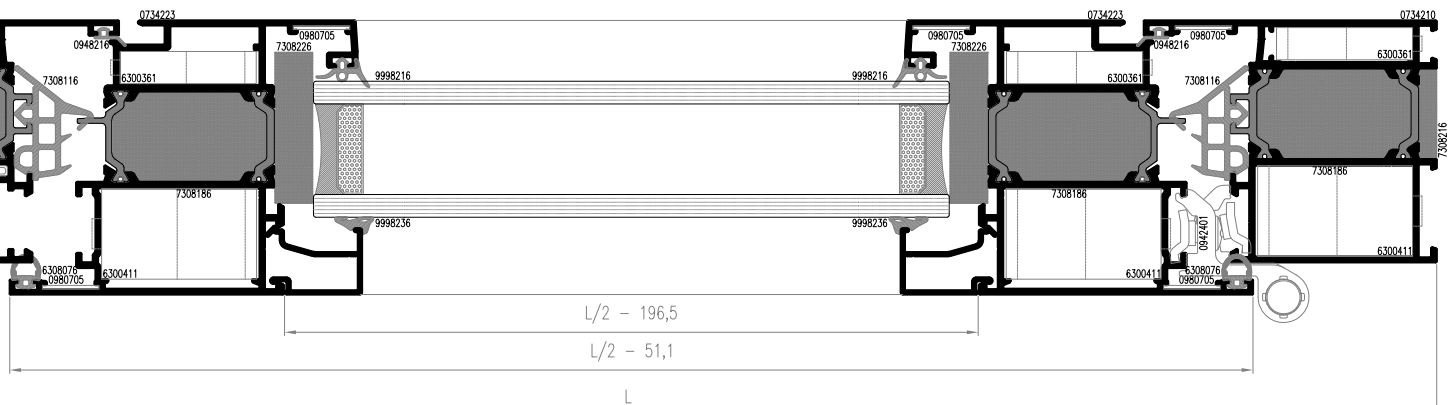
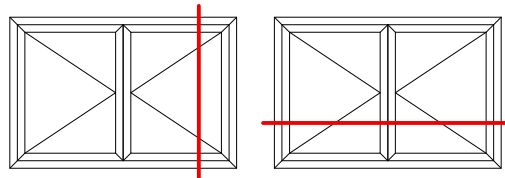

hojas de corte - GS-73 RT

Referencia	Descripción	Cantidad	Medida	Posición	Grados
0734210	MARCO PUERTA	2	L	Horizontal	45°
0734210	MARCO PUERTA	2	H	Vertical	45°
0734229	HOJA PUERTA APERTURA EXTERIOR	2	L - 97,2	Horizontal	45°
0734229	HOJA PUERTA APERTURA EXTERIOR	2	H - 97,2	Vertical	45°
***	JUNQUILLO	2	L - 242,6	Horizontal	90°
***	JUNQUILLO	2	H - 283,6	Vertical	90°
0942401	BISAGRA A IZQUIERDAS	2			
0948216	JUNTA MARCO	$L^*2 + H^*2$			
0980705	ESCUADRA ALINEAMIENTO	12			
6300361	ESCUADRA INTERIOR MARCO/HOJA	8			
6300411	ESCUADRA EXTERIOR MARCO/HOJA	8			
6308076	JUNTA HOJA	$L^*2 + H^*2$			
7308116	JUNTA CENTRAL	$L^*2 + H^*2$			
7308186	AISLANTE TÉRMICO MARCO EN POLIAMIDA	$L^*2 + H^*2$			
7308206	AISLANTE TÉRMICO HOJA EN POLIAMIDA	$L^*2 + H^*2$			
7308216	AISLANTE TÉRMICO MARCO EXTERIOR	$L^*2 + H^*2$			
7308226	AISLANTE TÉRMICO HOJA/VIDRIO	$L^*2 + H^*2$			
9998216	JUNTA ACRISTALAMIENTO EXTERIOR	$L^*2 + H^*2$			
9998236	JUNTA ACRISTALAMIENTO 3 mm	$L^*2 + H^*2$			

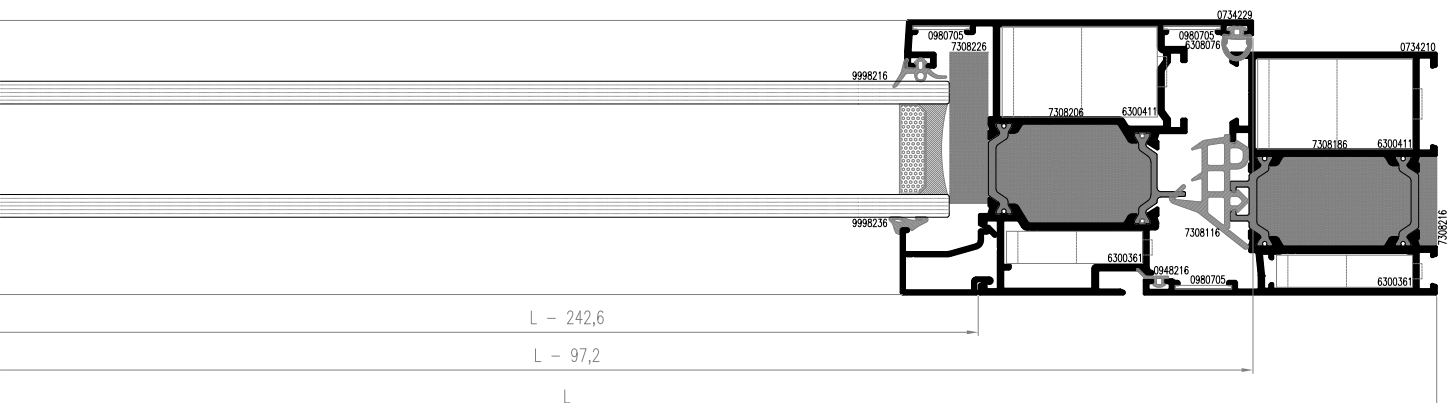
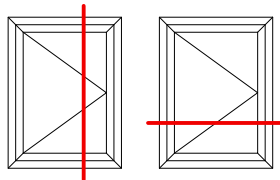

hojas de corte - GS-73 RT

Referencia	Descripción	Cantidad	Medida	Posición	Grados
0734210	MARCO PUERTA	2	L	Horizontal	45°
0734210	MARCO PUERTA	2	H	Vertical	45°
0734229	HOJA PUERTA APERTURA EXTERIOR	2	L/2 - 51,1	Horizontal	45°
0734229	HOJA PUERTA APERTURA EXTERIOR	4	H - 97,2	Vertical	45°
0731440	PERFIL INVERSOR	1	H - 175	Vertical	90°
***	JUNQUILLO	2	L/2 - 196,5	Horizontal	90°
***	JUNQUILLO	4	H - 283,6	Vertical	90°
0942401	BISAGRA A IZQUIERDAS	2			
0942411	BISAGRA A DERECHAS	2			
0948216	JUNTA MARCO	L*2 + H*3			
0980705	ESCUADRA ALINEAMIENTO	20			
6300361	ESCUADRA INTERIOR MARCO/HOJA	12			
6300411	ESCUADRA EXTERIOR MARCO/HOJA	12			
6308076	JUNTA HOJA	L*2 + H*4			
7303123	TAPÓN DE INVERSORA	1			
7308116	JUNTA CENTRAL	L*2 + H*3			
7308176	AISLANTE TÉRMICO INVERSOR EN POLIAMIDA	H			
7308186	AISLANTE TÉRMICO MARCO EN POLIAMIDA	L*2 + H*2			
7308206	AISLANTE TÉRMICO HOJA EN POLIAMIDA	L*2 + H*4			
7308216	AISLANTE TÉRMICO MARCO EXTERIOR	L*2 + H*2			
7308226	AISLANTE TÉRMICO HOJA/VIDRIO	L*2 + H*4			
9998216	JUNTA ACRISTALAMIENTO EXTERIOR	L*2 + H*4			
9998236	JUNTA ACRISTALAMIENTO 3 mm	L*2 + H*4			

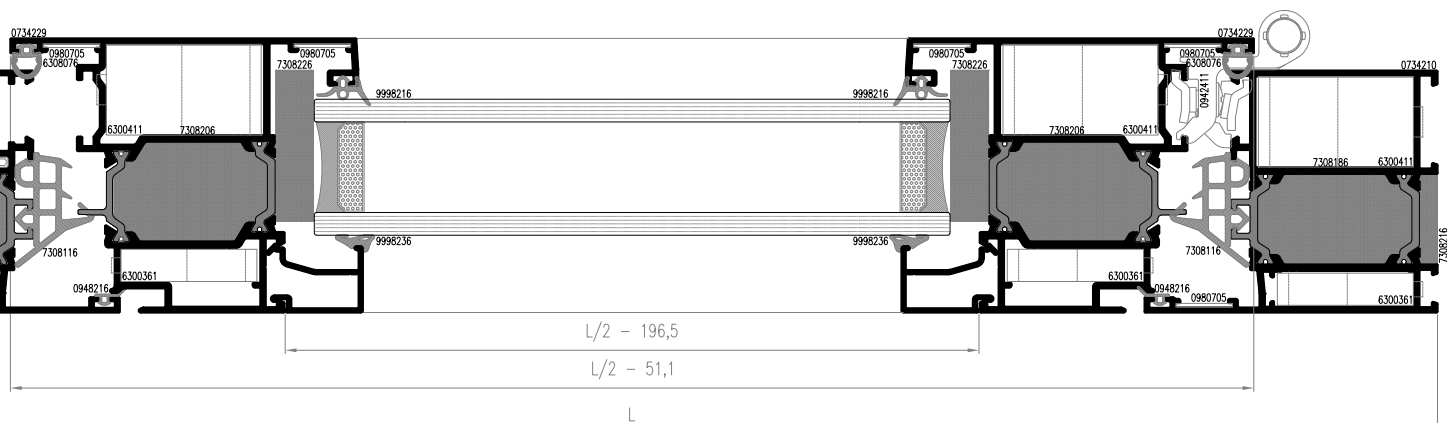
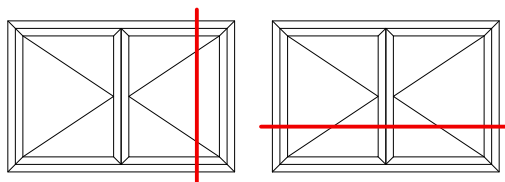

hojas de corte - GS-73 RT

Referencia	Descripción	Cantidad	Medida	Posición	Grados
0734210	MARCO PUERTA	1	L	Horizontal	45°
0734210	MARCO PUERTA	2	H	Vertical	45°
0734223	HOJA PUERTA	2	L - 97,2	Horizontal	45°
0734223	HOJA PUERTA	2	H - 57,6	Vertical	45°
0731210	PERFIL UMBRAL	1	L - 110	Horizontal	90°
730424	PERFIL COMPLEMENTO UMBRAL	1	L - 165	Horizontal	90°
940423	VIERTEAGUAS	1	L - 165	Horizontal	90°
***	JUNQUILLO	2	L - 242,6	Horizontal	90°
***	JUNQUILLO	2	H - 244	Vertical	90°
0942411	BISAGRA A IZQUIERDAS	2			
0948216	JUNTA MARCO	L + H*2			
0980705	ESCUADRA ALINEAMIENTO	10			
6300361	ESCUADRA EXTERIOR MARCO/HOJA	6			
6300411	ESCUADRA INTERIOR MARCO/HOJA	6			
6308076	JUNTA HOJA	L*3 + H*2			
7308116	JUNTA CENTRAL	L + H*2			
7308186	AISLANTE TÉRMICO MARCO/HOJA EN POLIAMIDA	L*3 + H*4			
7308216	AISLANTE TÉRMICO MARCO EXTERIOR	L + H*2			
7308226	AISLANTE TÉRMICO HOJA/VIDRIO	L*2 + H*2			
9998216	JUNTA ACRISTALAMIENTO EXTERIOR	L*2 + H*2			
9998236	JUNTA ACRISTALAMIENTO 3 mm	L*2 + H*2			

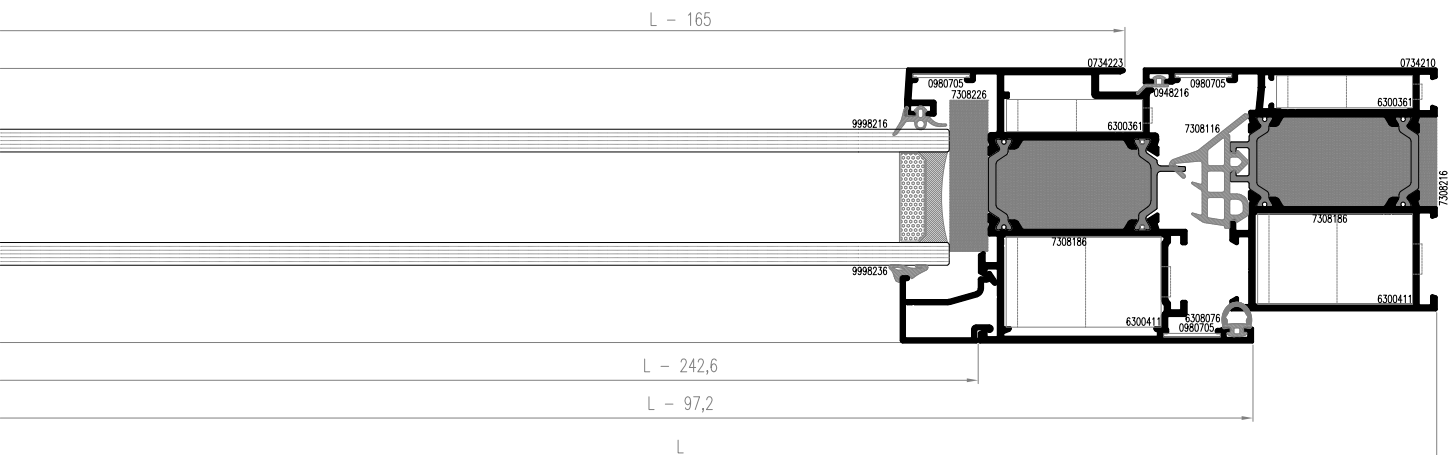
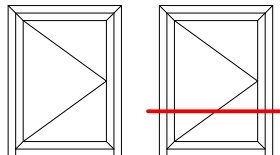

GS-73 RT - hojas de corte

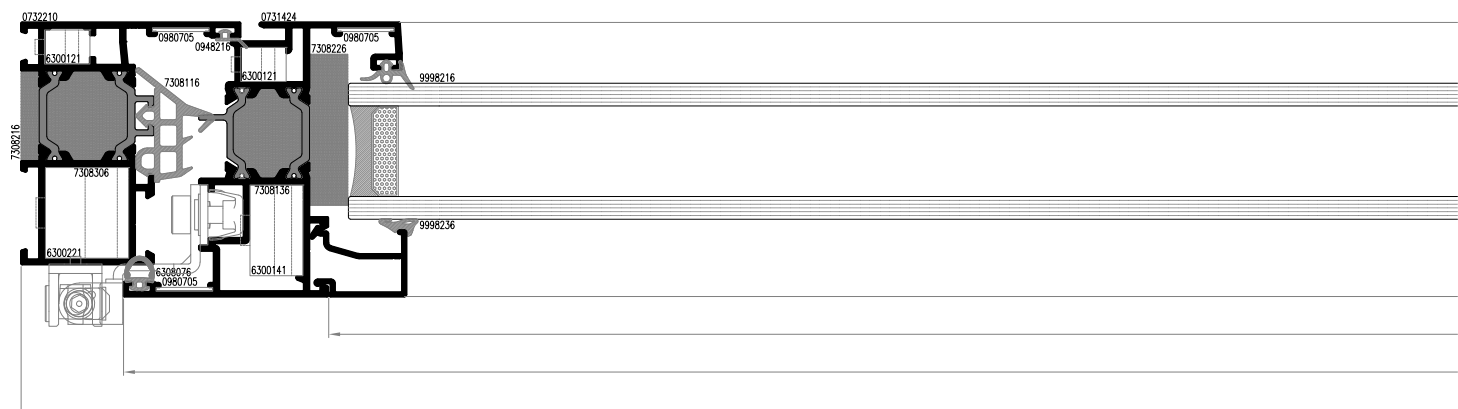
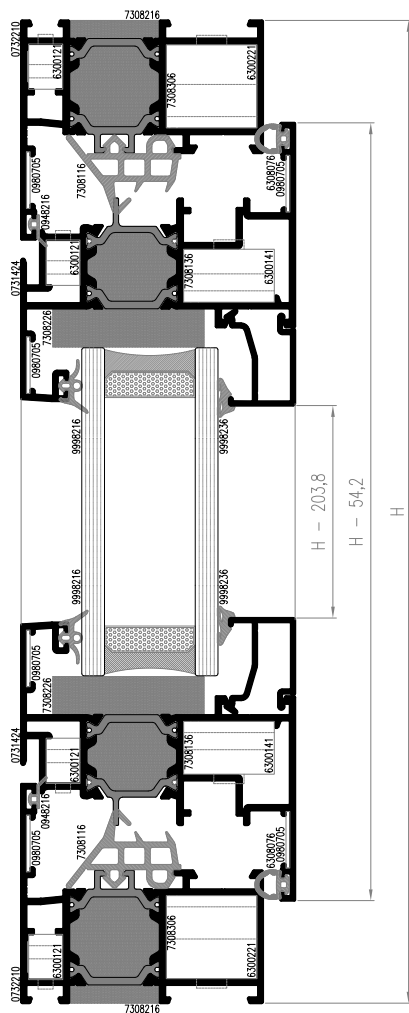

hojas de corte - GS-73 RT

Referencia	Descripción	Cantidad	Medida	Posición	Grados
0732210	MARCO VENTANA	2	L	Horizontal	45°
0732210	MARCO VENTANA	2	H	Vertical	45°
0731424	HOJA VENTANA	2	L - 54,2	Horizontal	45°
0731424	HOJA VENTANA	2	H - 54,2	Vertical	45°
***	JUNQUILLO	2	L - 162,8	Horizontal	90°
***	JUNQUILLO	2	H - 203,8	Vertical	90°
0948216	JUNTA MARCO	L*2 + H*2			
0980705	ESCUADRA ALINEAMIENTO	12			
6300121	ESCUADRA EXTERIOR MARCO/HOJA	8			
6300141	ESCUADRA INTERIOR HOJA	4			
6300221	ESCUADRA INTERIOR MARCO	4			
6308076	JUNTA HOJA	L*2 + H*2			
7308116	JUNTA CENTRAL	L*2 + H*2			
7308136	AISLANTE TÉRMICO HOJA EN POLIAMIDA	L*2 + H*2			
7308216	AISLANTE TÉRMICO MARCO EXTERIOR	L*2 + H*2			
7308226	AISLANTE TÉRMICO HOJA/VIDRIO	L*2 + H*2			
7308306	AISLANTE TÉRMICO MARCO EN POLIAMIDA	L*2 + H*2			
9998216	JUNTA ACRISTALAMIENTO EXTERIOR	L*2 + H*2			
9998236	JUNTA ACRISTALAMIENTO 3 mm	L*2 + H*2			

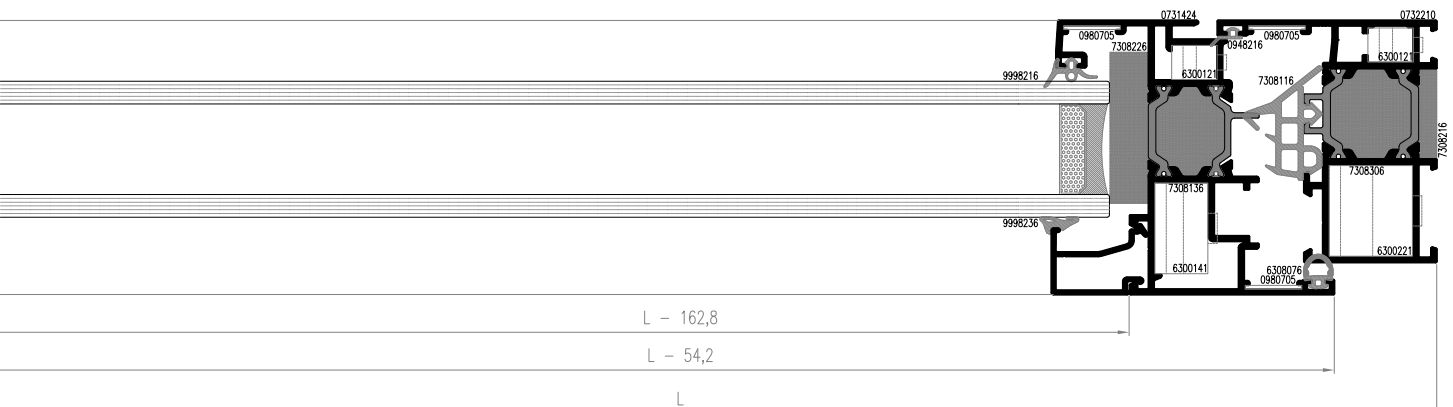
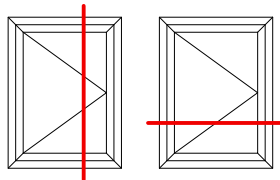

GS-73 RT - hojas de corte

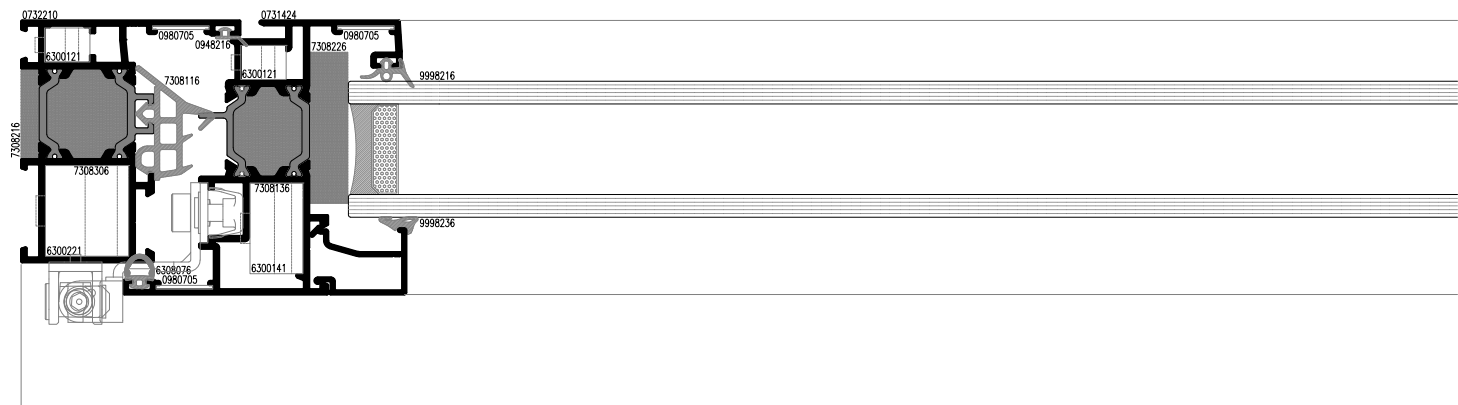
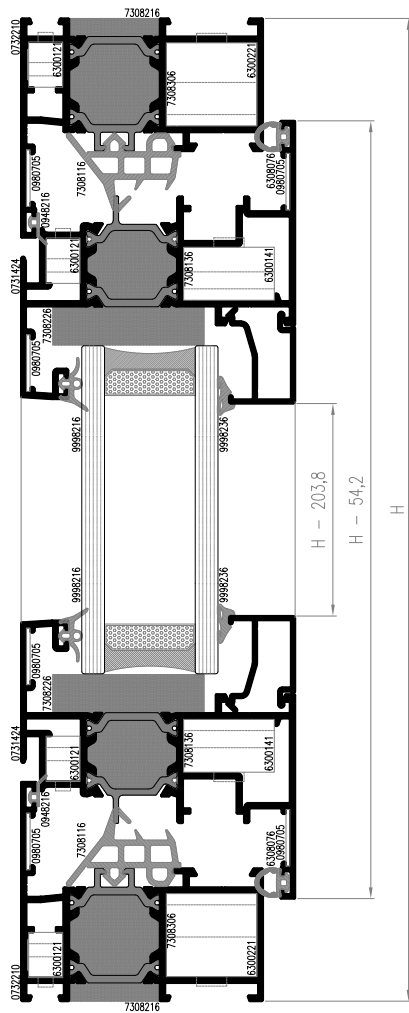

hojas de corte - GS-73 RT

Referencia	Descripción	Cantidad	Medida	Posición	Grados
0732210	MARCO VENTANA	2	L	Horizontal	45°
0732210	MARCO VENTANA	2	H	Vertical	45°
0731424	HOJA VENTANA	2	L/2 - 29,6	Horizontal	45°
0731424	HOJA VENTANA	4	H - 54,2	Vertical	45°
0731441	PERFIL INVERSOR	1	H - 132	Vertical	90°
***	JUNQUILLO	2	L/2 - 138,2	Horizontal	90°
***	JUNQUILLO	4	H - 203,8	Vertical	90°
0948216	JUNTA MARCO	L*2 + H*3			
0980705	ESCUADRA ALINEAMIENTO	20			
6300121	ESCUADRA EXTERIOR MARCO/HOJA	12			
6300141	ESCUADRA INTERIOR HOJA	8			
6300221	ESCUADRA INTERIOR MARCO	4			
6308076	JUNTA HOJA	L*2 + H*4			
7303133	TAPÓN DE INVERSORA	1			
7308116	JUNTA CENTRAL	L*2 + H*3			
7308136	AISLANTE TÉRMICO HOJA EN POLIAMIDA	L*2 + H*4			
7308216	AISLANTE TÉRMICO MARCO EXTERIOR	L*2 + H*2			
7308226	AISLANTE TÉRMICO HOJA/VIDRIO	L*2 + H*4			
7308246	AISLANTE TÉRMICO INVERSOR EN POLIAMIDA	H			
7308306	AISLANTE TÉRMICO MARCO EN POLIAMIDA	L*2 + H*2			
9998216	JUNTA ACRISTALAMIENTO EXTERIOR	L*2 + H*4			
9998236	JUNTA ACRISTALAMIENTO 3 mm	L*2 + H*4			

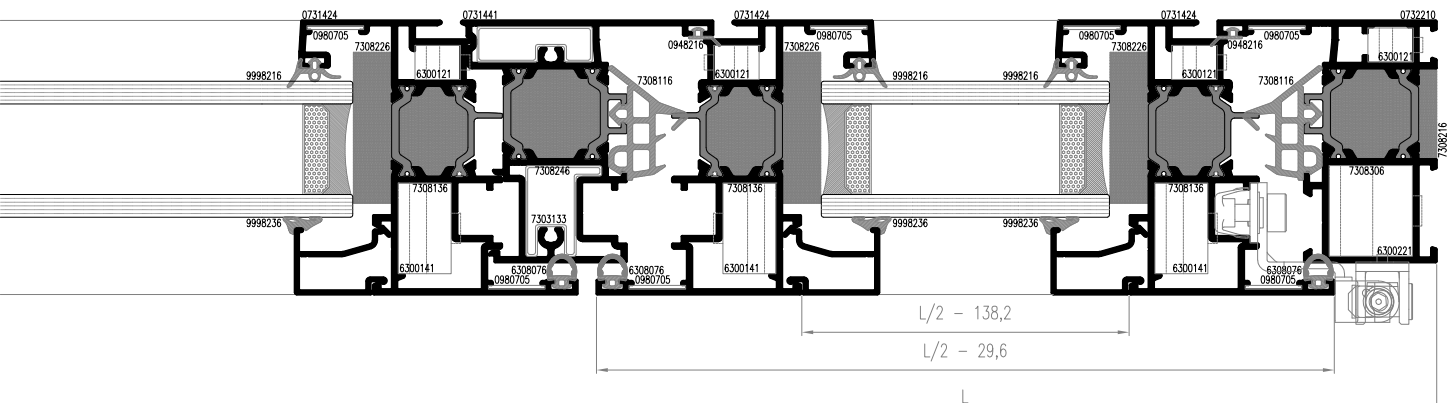
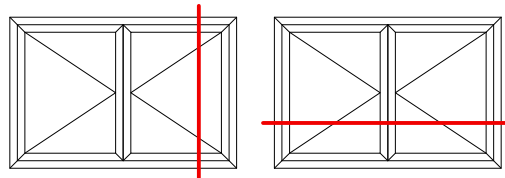

GS-73 RT - hojas de corte

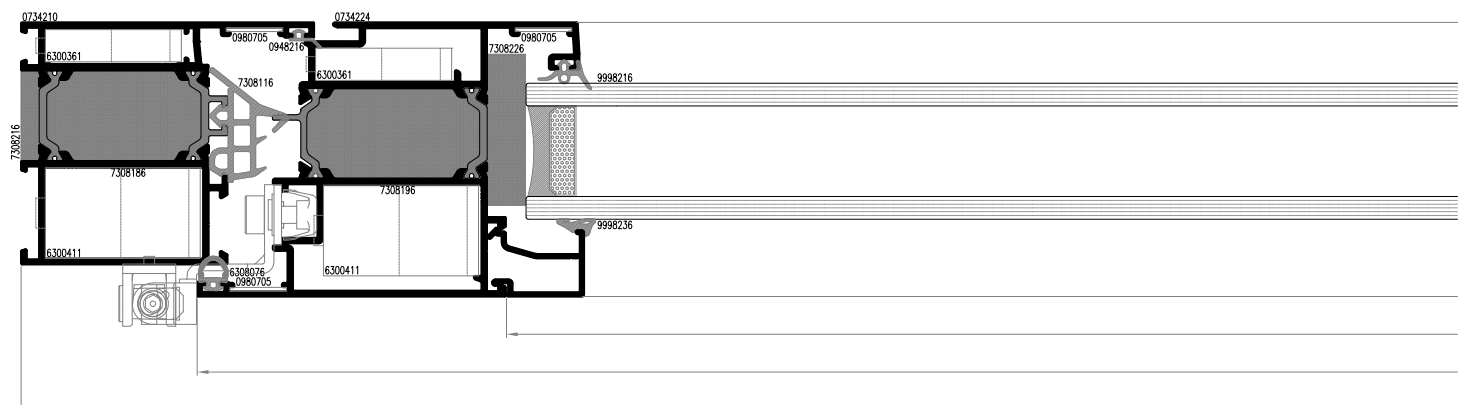
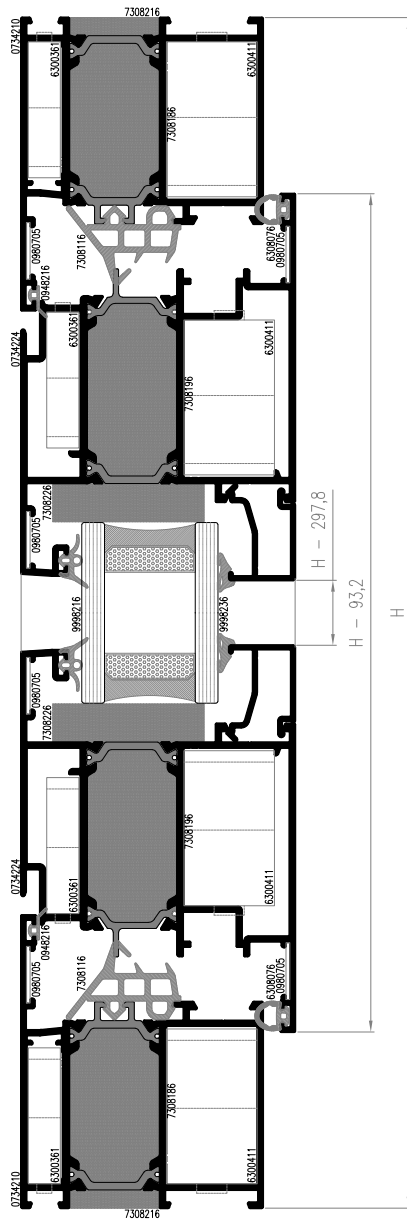

hojas de corte - GS-73 RT

Referencia	Descripción	Cantidad	Medida	Posición	Grados
0734210	MARCO PUERTA	2	L	Horizontal	45°
0734210	MARCO PUERTA	2	H	Vertical	45°
0734224	HOJA PUERTA	2	L - 93,2	Horizontal	45°
0734224	HOJA PUERTA	2	H - 93,2	Vertical	45°
***	JUNQUILLO	2	L - 256,8	Horizontal	90°
***	JUNQUILLO	2	H - 297,8	Vertical	90°
0948216	JUNTA MARCO	L*2 + H*2			
0980705	ESCUADRA ALINEAMIENTO	12			
6300361	ESCUADRA EXTERIOR MARCO/HOJA	8			
6300411	ESCUADRA INTERIOR MARCO/HOJA	8			
6308076	JUNTA HOJA	L*2 + H*2			
7308116	JUNTA CENTRAL	L*2 + H*2			
7308186	AISLANTE TÉRMICO MARCO EN POLIAMIDA	L*2 + H*2			
7308196	AISLANTE TÉRMICO HOJA EN POLIAMIDA	L*2 + H*2			
7308216	AISLANTE TÉRMICO MARCO EXTERIOR	L*2 + H*2			
7308226	AISLANTE TÉRMICO HOJA/VIDRIO	L*2 + H*2			
9998216	JUNTA ACRISTALAMIENTO EXTERIOR	L*2 + H*2			
9998236	JUNTA ACRISTALAMIENTO 3 mm	L*2 + H*2			

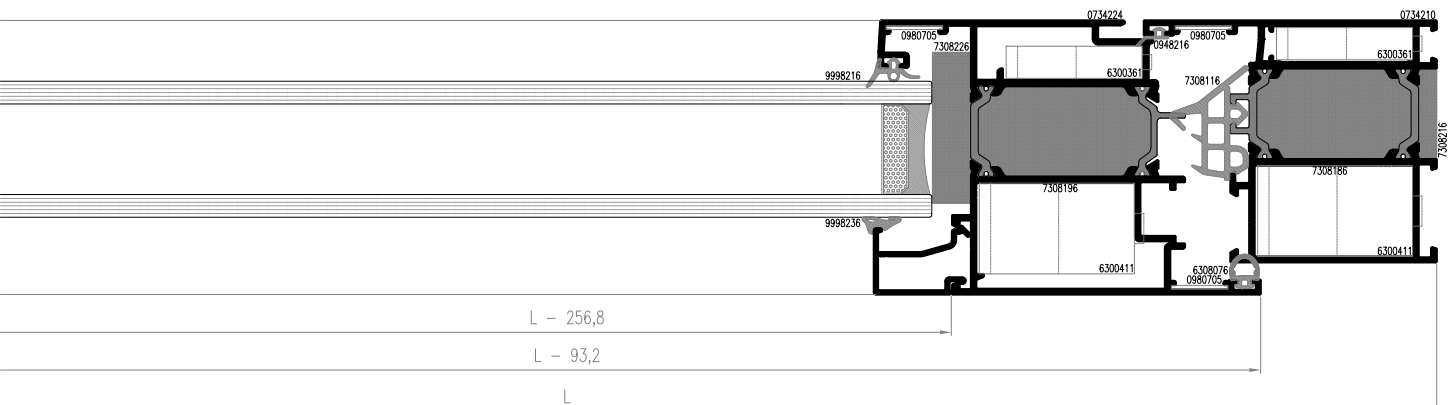
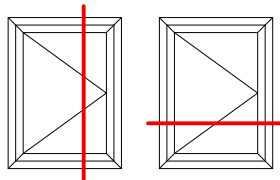

hojas de corte - GS-73 RT

Referencia	Descripción	Cantidad	Medida	Posición	Grados
0734210	MARCO PUERTA	2	L	Horizontal	45°
0734210	MARCO PUERTA	2	H	Vertical	45°
0734224	HOJA PUERTA	2	L/2 - 49,1	Horizontal	45°
0734224	HOJA PUERTA	4	H - 93,2	Vertical	45°
0731441	PERFIL INVERSOR	1	H - 171	Vertical	90°
***	JUNQUILLO	2	L/2 - 212,7	Horizontal	90°
***	JUNQUILLO	4	H - 297,8	Vertical	90°
0948216	JUNTA MARCO	L*2 + H*3			
0980705	ESCUADRA ALINEAMIENTO	20			
6300121	ESCUADRA EXTERIOR MARCO/HOJA	12			
6300141	ESCUADRA INTERIOR MARCO/HOJA	12			
6308076	JUNTA HOJA	L*2 + H*4			
7303133	TAPÓN DE INVERSORA	1			
7308116	JUNTA CENTRAL	L*2 + H*3			
7308186	AISLANTE TÉRMICO MARCO EN POLIAMIDA	L*2 + H*2			
7308196	AISLANTE TÉRMICO HOJA EN POLIAMIDA	L*2 + H*4			
7308216	AISLANTE TÉRMICO MARCO EXTERIOR	L*2 + H*2			
7308226	AISLANTE TÉRMICO HOJA/VIDRIO	L*2 + H*4			
7308246	AISLANTE TÉRMICO INVERSOR EN POLIAMIDA	H			
9998216	JUNTA ACRISTALAMIENTO EXTERIOR	L*2 + H*4			
9998236	JUNTA ACRISTALAMIENTO 3 mm	L*2 + H*4			

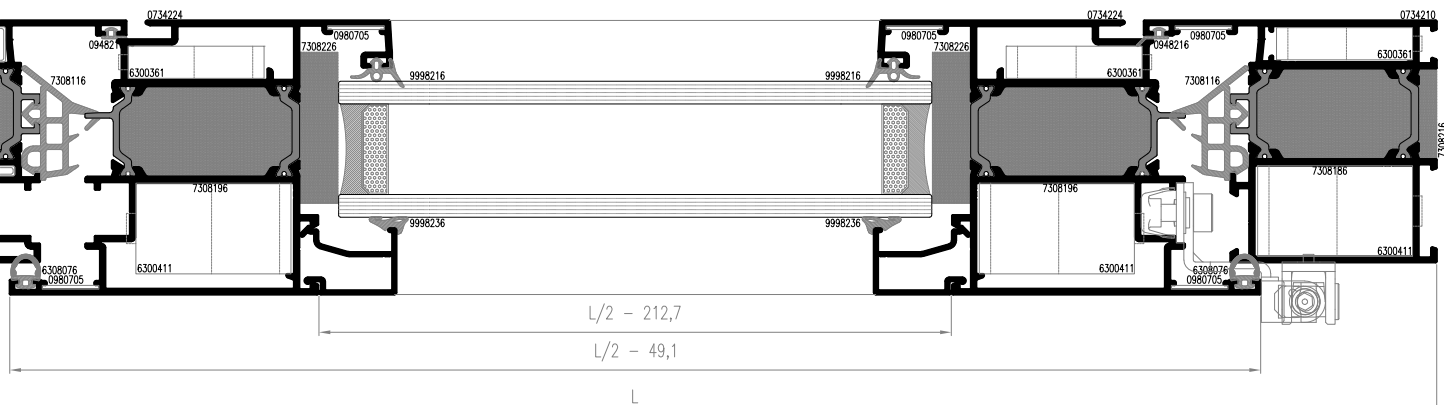
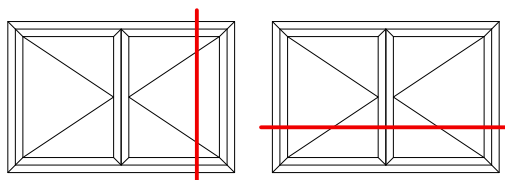

hojas de corte - GS-73 RT

Referencia	Descripción	Cantidad	Medida	Posición	Grados
0734210	MARCO PUERTA	2	L	Horizontal	45°
0734210	MARCO PUERTA	2	H	Vertical	45°
0734228	HOJA PUERTA APERTURA EXTERIOR	2	L - 93,2	Horizontal	45°
0734228	HOJA PUERTA APERTURA EXTERIOR	2	H - 93,2	Vertical	45°
***	JUNQUILLO	2	L - 270,8	Horizontal	90°
***	JUNQUILLO	2	H - 311,8	Vertical	90°
0948216	JUNTA MARCO	L*2 + H*2			
0980705	ESCUADRA ALINEAMIENTO	12			
6300361	ESCUADRA INTERIOR MARCO/HOJA	8			
6300411	ESCUADRA EXTERIOR MARCO/HOJA	8			
6308076	JUNTA HOJA	L*2 + H*2			
7308116	JUNTA CENTRAL	L*2 + H*2			
7308186	AISLANTE TÉRMICO MARCO EN POLIAMIDA	L*2 + H*2			
7308216	AISLANTE TÉRMICO MARCO EXTERIOR	L*2 + H*2			
7308226	AISLANTE TÉRMICO HOJA/VIDRIO	L*2 + H*2			
7308256	AISLANTE TÉRMICO HOJA EN POLIAMIDA	L*2 + H*2			
9998216	JUNTA ACRISTALAMIENTO EXTERIOR	L*2 + H*2			
9998236	JUNTA ACRISTALAMIENTO 3 mm	L*2 + H*2			

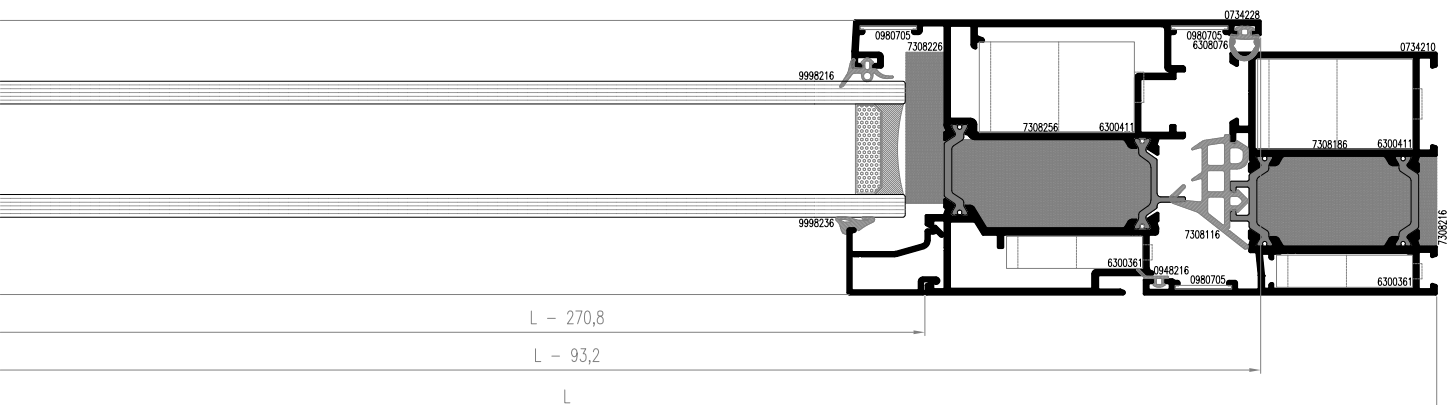
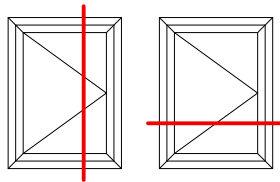

hojas de corte - GS-73 RT

Referencia	Descripción	Cantidad	Medida	Posición	Grados
0734210	MARCO PUERTA	2	L	Horizontal	45°
0734210	MARCO PUERTA	2	H	Vertical	45°
0734228	HOJA PUERTA APERTURA EXTERIOR	2	L/2 - 49,1	Horizontal	45°
0734228	HOJA PUERTA APERTURA EXTERIOR	4	H - 93,2	Vertical	45°
0731441	PERFIL INVERSOR	1	H - 171	Vertical	90°
***	JUNQUILLO	2	L/2 - 226,7	Horizontal	90°
***	JUNQUILLO	4	H - 311,8	Vertical	90°
0948216	JUNTA MARCO	L*2 + H*3			
0980705	ESCUADRA ALINEAMIENTO	20			
6300361	ESCUADRA INTERIOR MARCO/HOJA	12			
6300411	ESCUADRA EXTERIOR MARCO/HOJA	12			
6308076	JUNTA HOJA	L*2 + H*4			
7303133	TAPÓN DE INVERSORA	1			
7308116	JUNTA CENTRAL	L*2 + H*3			
7308186	AISLANTE TÉRMICO MARCO EN POLIAMIDA	L*2 + H*2			
7308216	AISLANTE TÉRMICO MARCO EXTERIOR	L*2 + H*2			
7308226	AISLANTE TÉRMICO HOJA/VIDRIO	L*2 + H*4			
7308246	AISLANTE TÉRMICO INVERSOR EN POLIAMIDA	H			
7308256	AISLANTE TÉRMICO HOJA EN POLIAMIDA	L*2 + H*4			
9998216	JUNTA ACRISTALAMIENTO EXTERIOR	L*2 + H*4			
9998236	JUNTA ACRISTALAMIENTO 3 mm	L*2 + H*4			

