

## STRUCTURAL CURTAIN WALL MURO ESTRUCTURAL

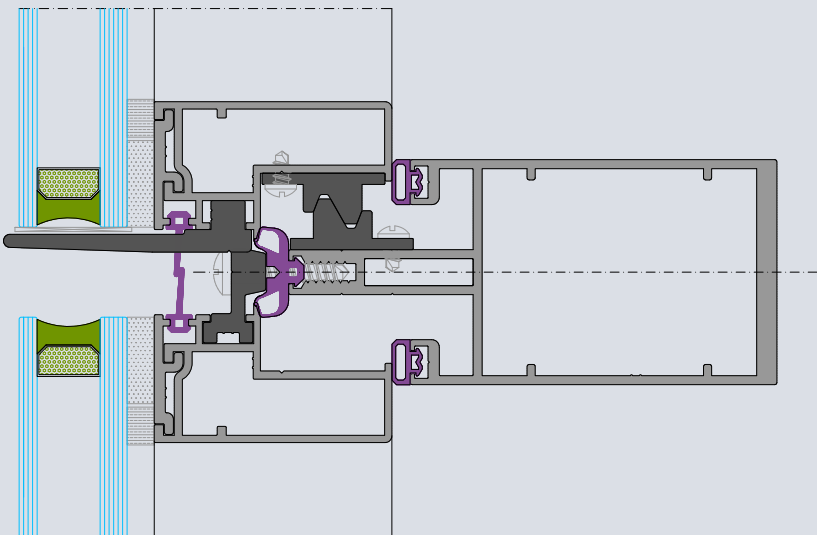

### **MORE INFORMATION - MÁS INFORMACIÓN**

Visit our website for more information of this series and to download the documentation in pdf format.

*Visite nuestra página web para una mayor información de esta serie y poder descargar la documentación en formato pdf.*

[www.gruposopena.com](http://www.gruposopena.com)



# Sections

## *Secciones*

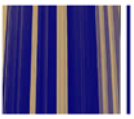

Sections - *Secciones*

- SECCION HORIZONTAL FIJOS -

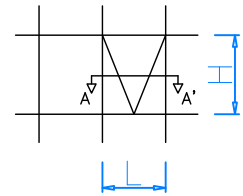

SECCION A-A'

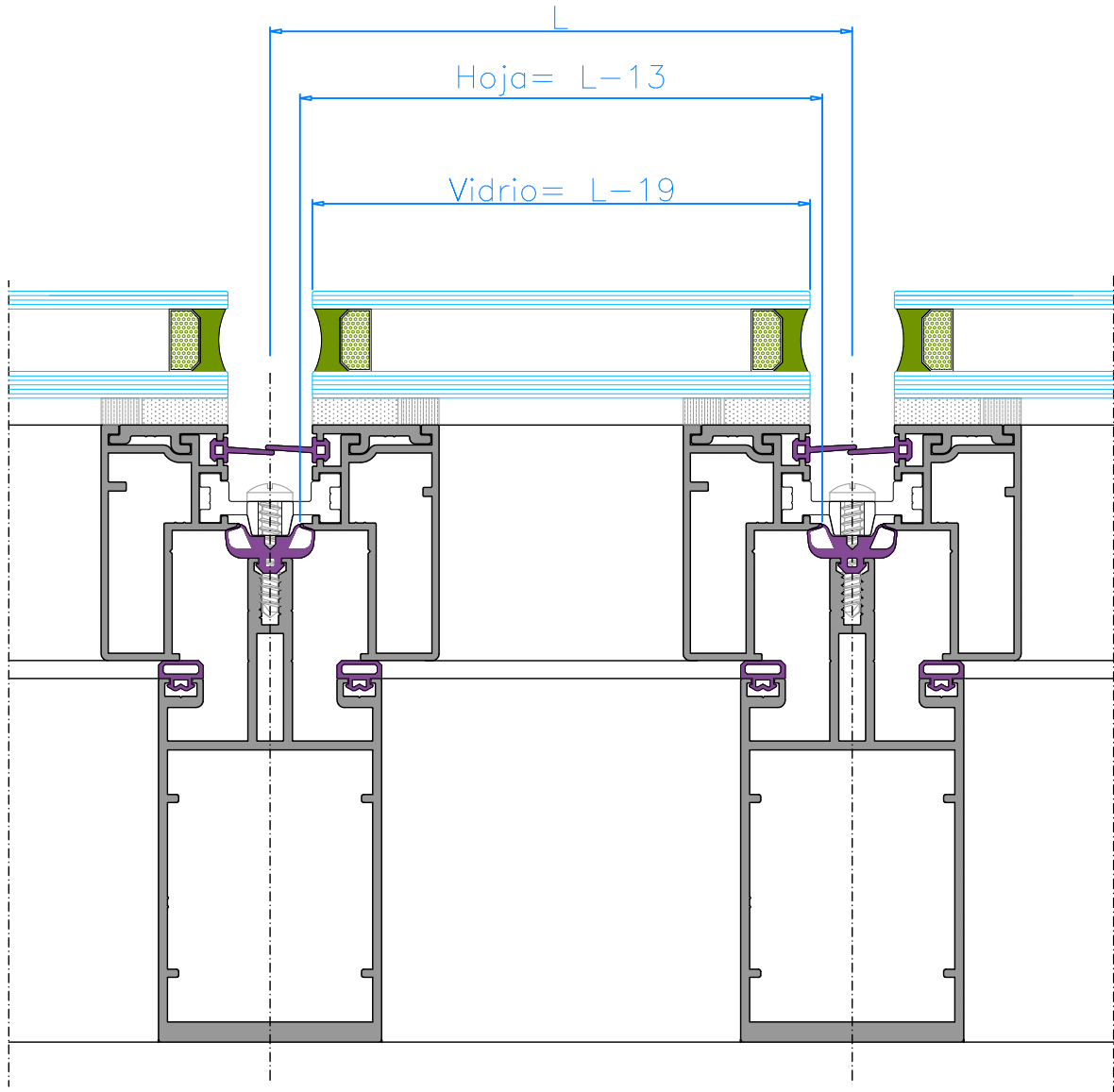



Sections - *Secciones*

- SECCION VERTICAL FIJO Y PROYECTANTE -

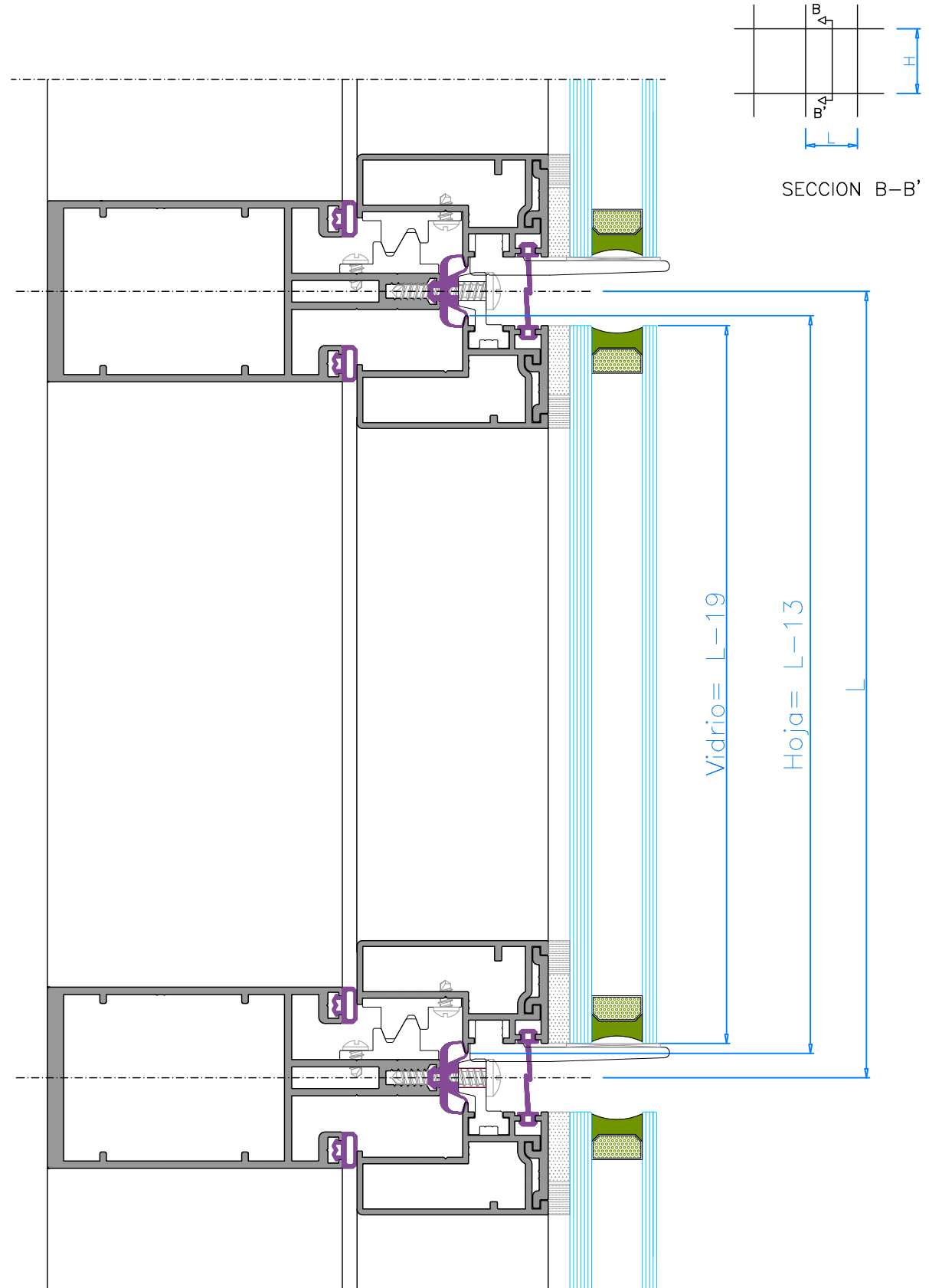

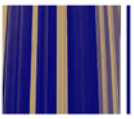

Sections - *Secciones*

- SECCION HORIZONTAL PROYECTANTE -

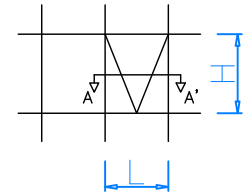

SECCION A-A'

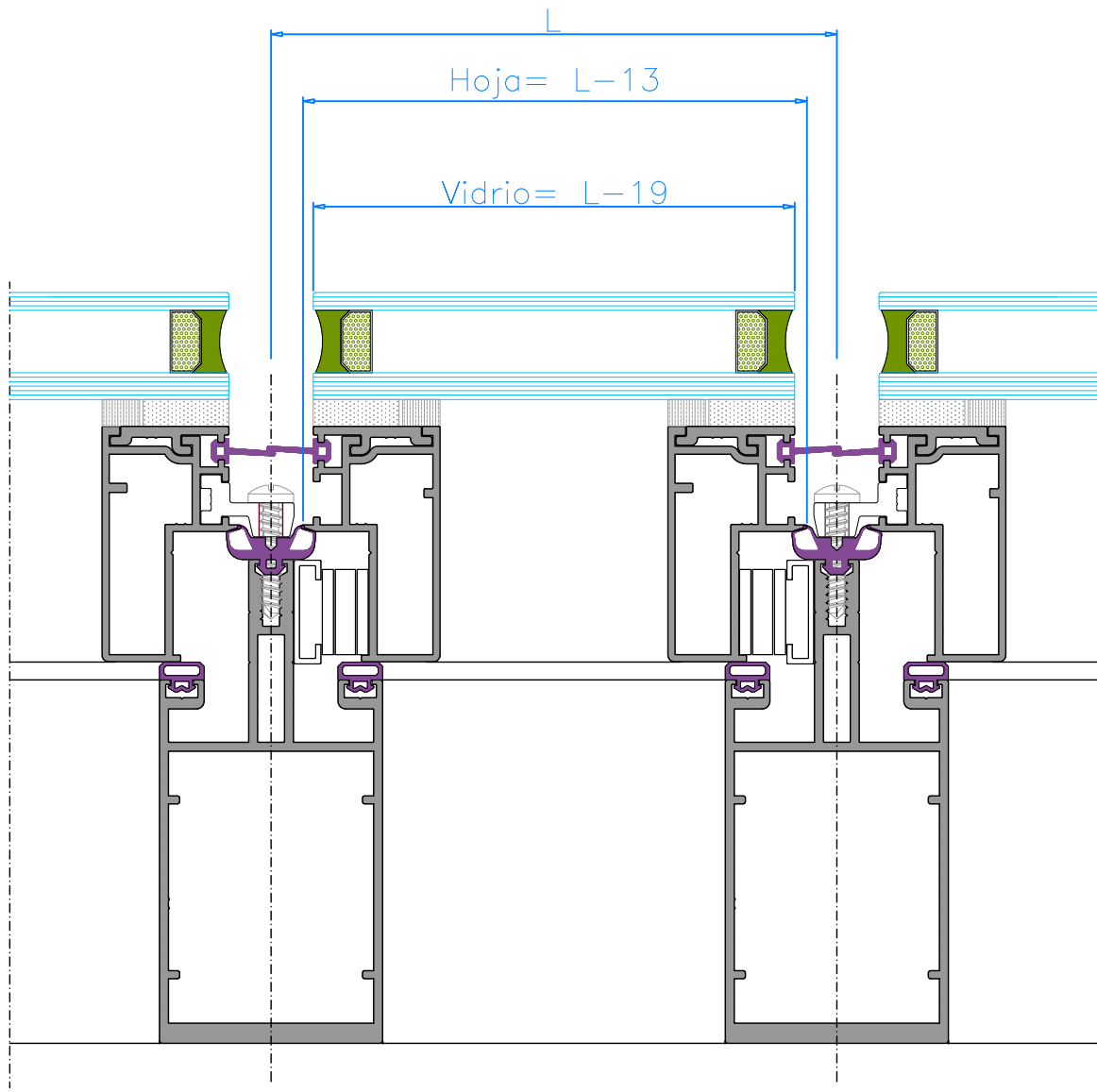



Sections - *Secciones*

- SECCION NUDO CENTRAL TRAVESAÑO -

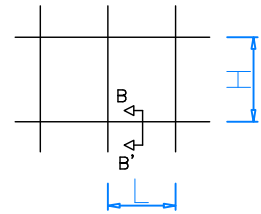

SECCION B-B'

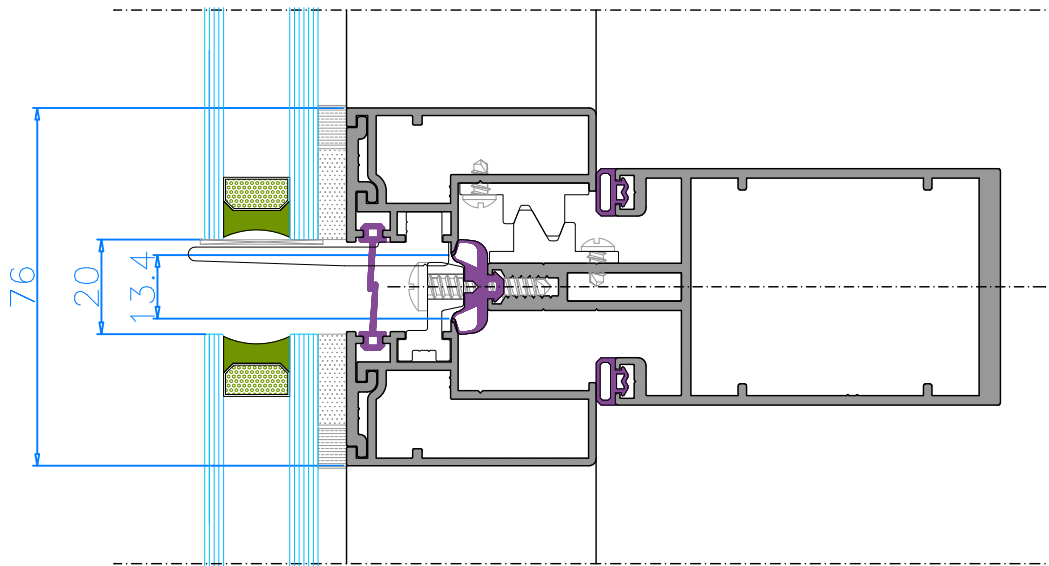

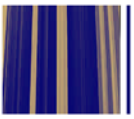

Sections - *Secciones*

- SECCION NUDO LATERAL -

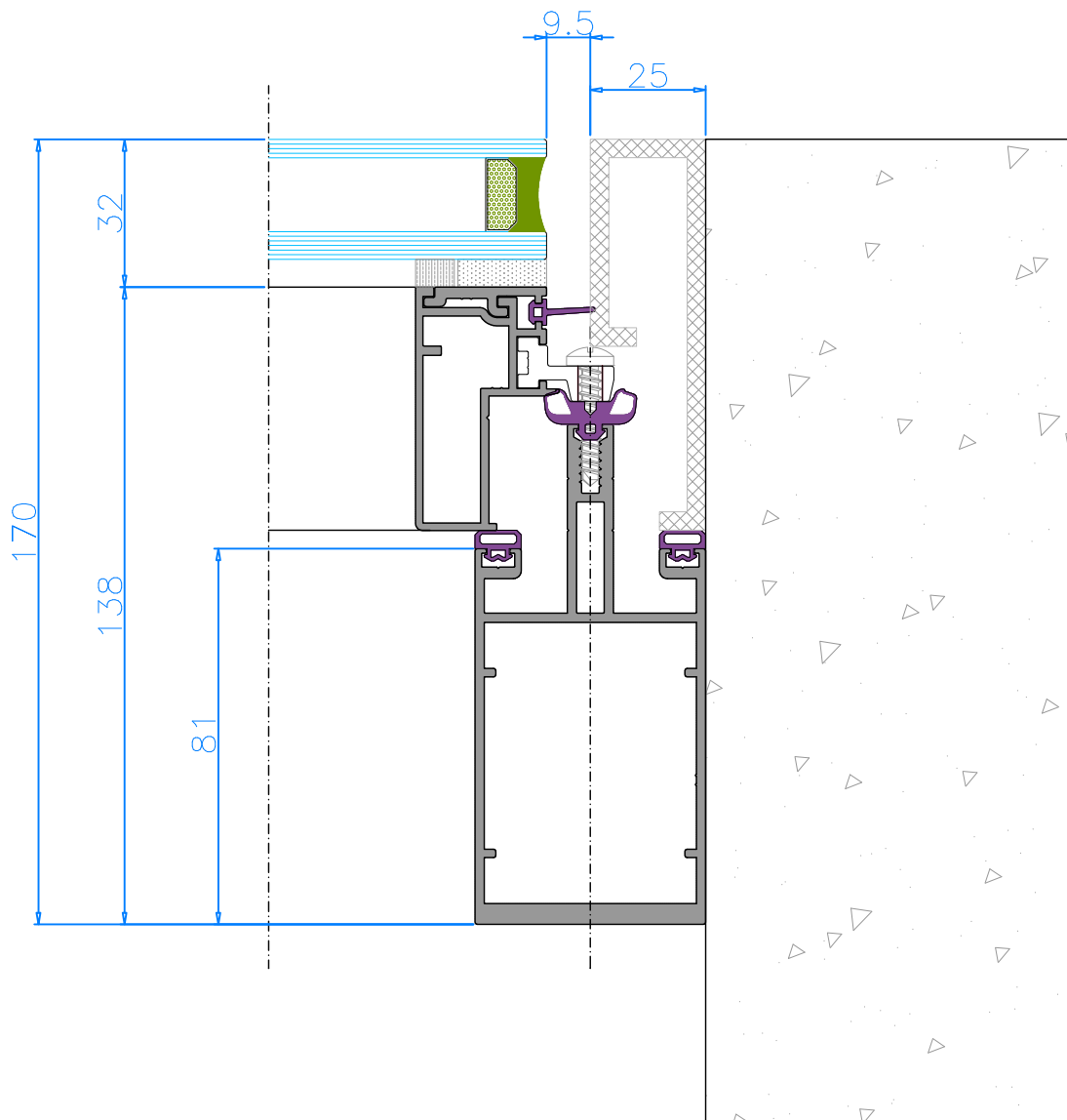

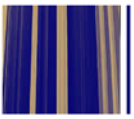

Sections - *Secciones*

- SECCION HORIZONTAL FIJOS -

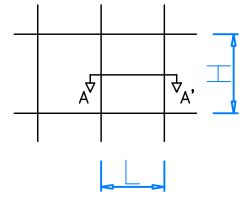

SECCION A-A'

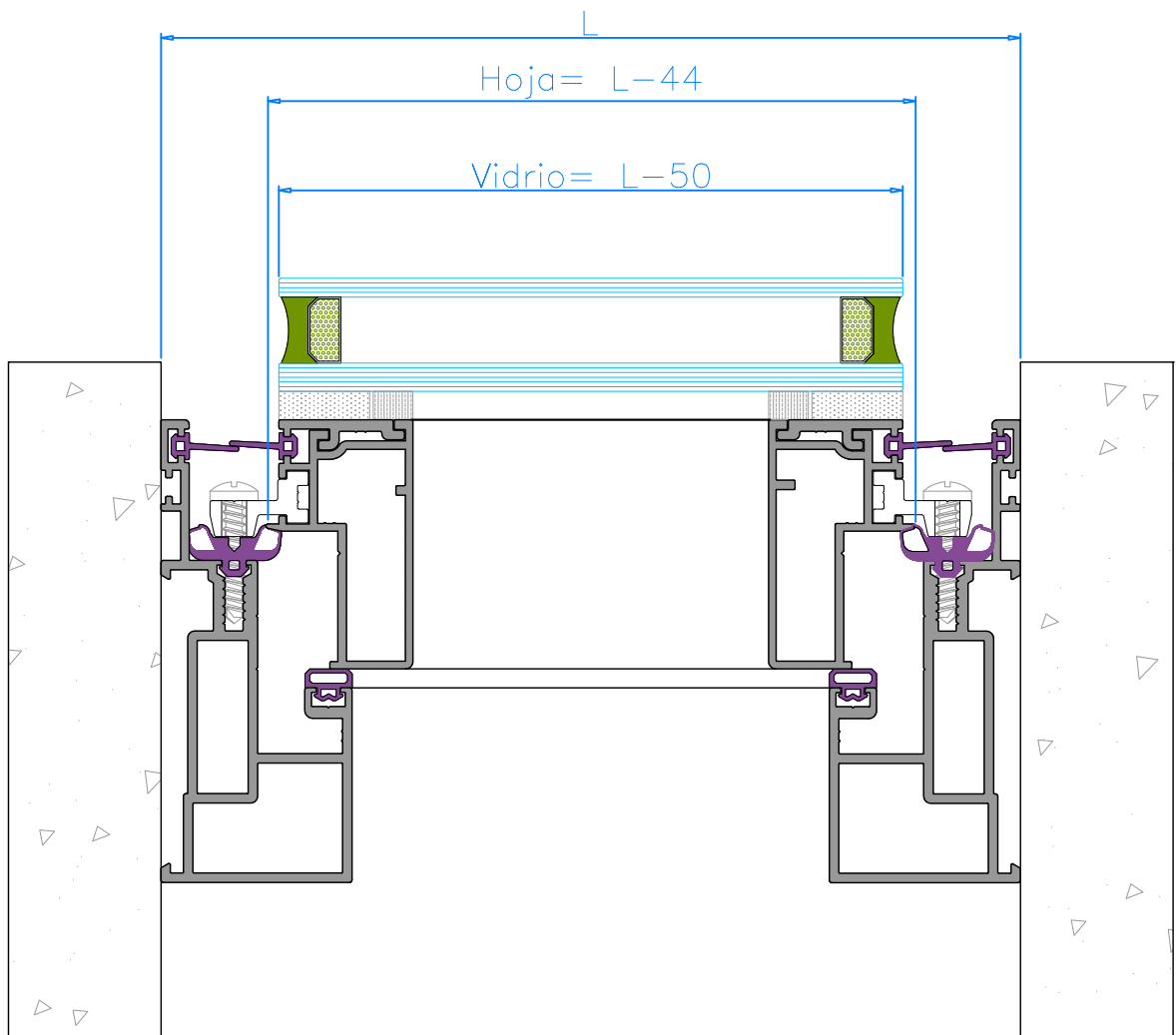



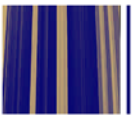

Sections - *Secciones*

- SECCION VERTICAL -

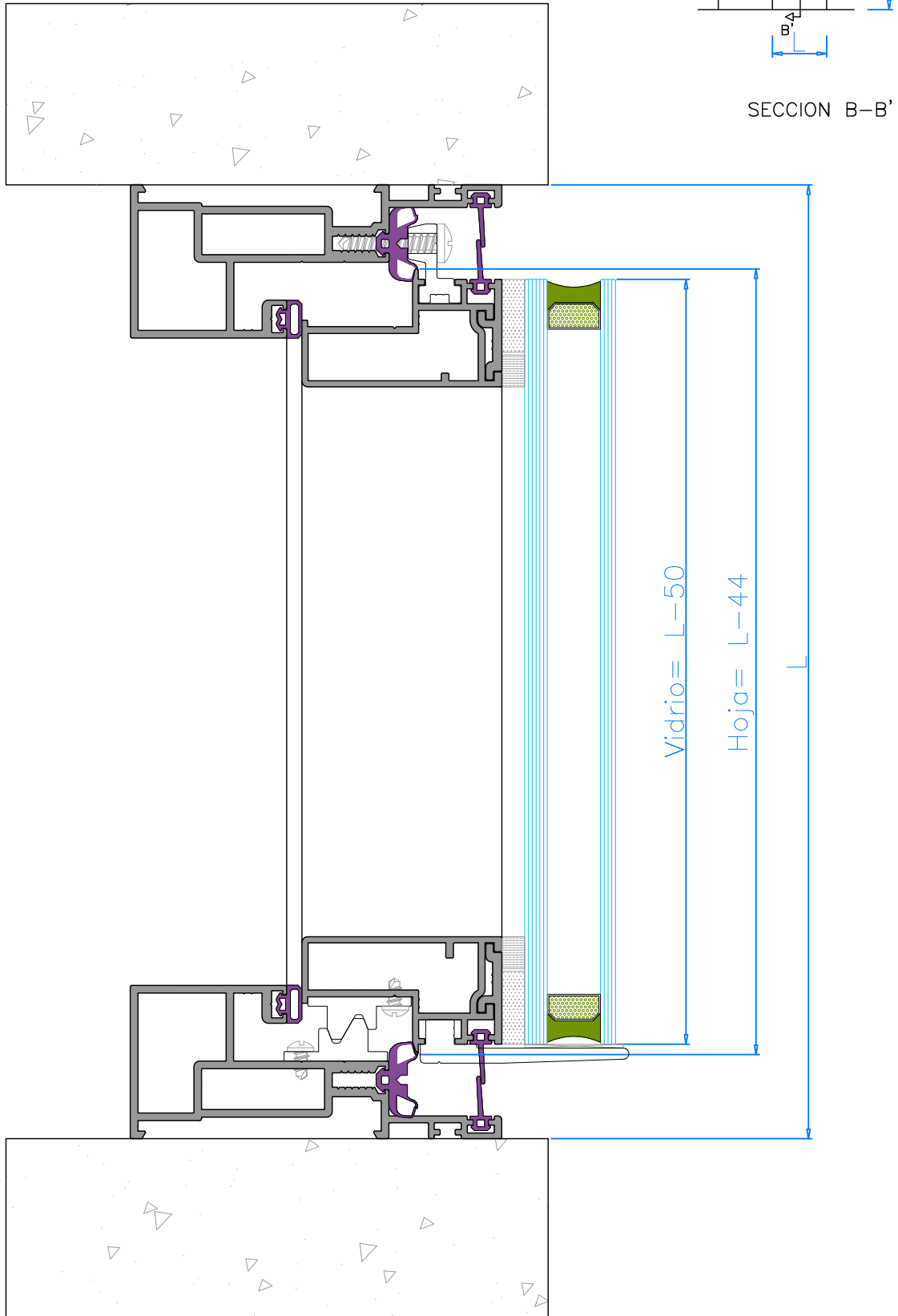

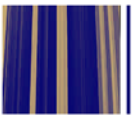

Sections - *Secciones*

- SECCION NUDO LATERAL -

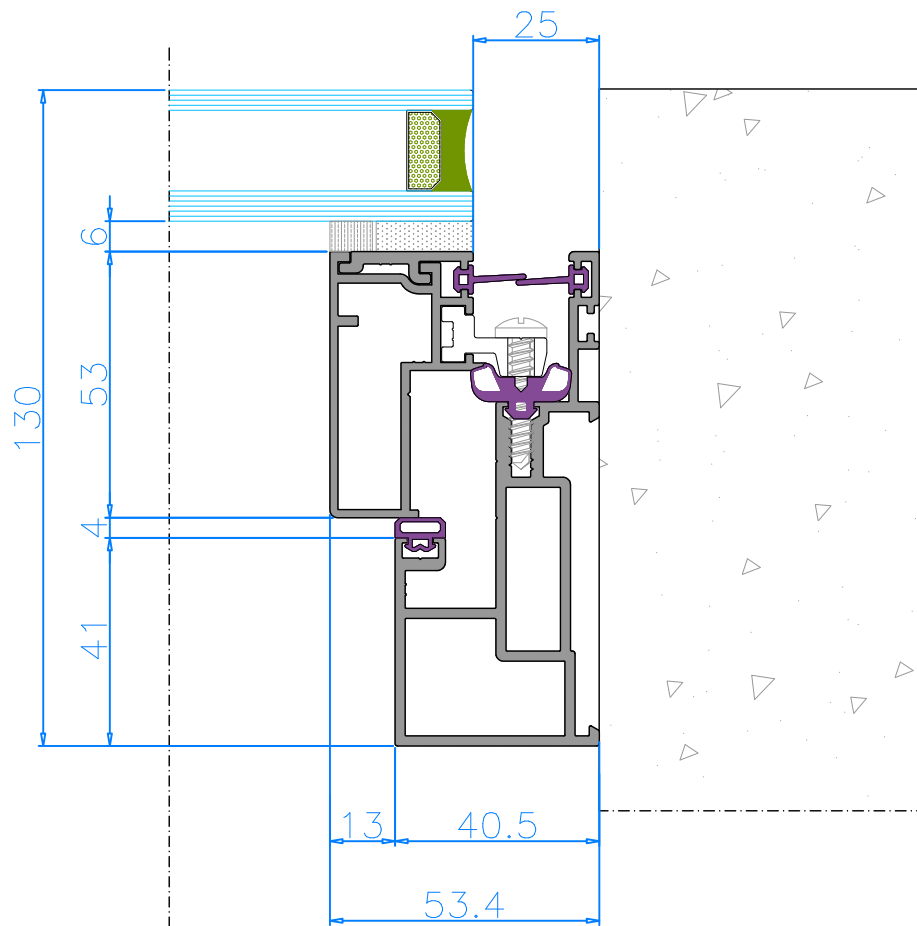

Sections - Secciones

- BASTIDOR DE DOS VENTANAS PROYECTANTES Y DOS FIJOS -

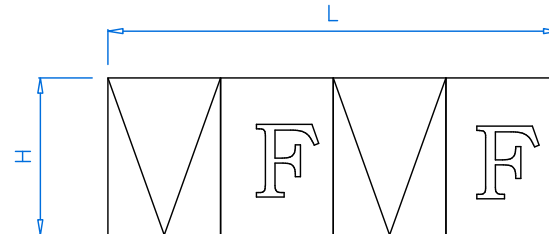
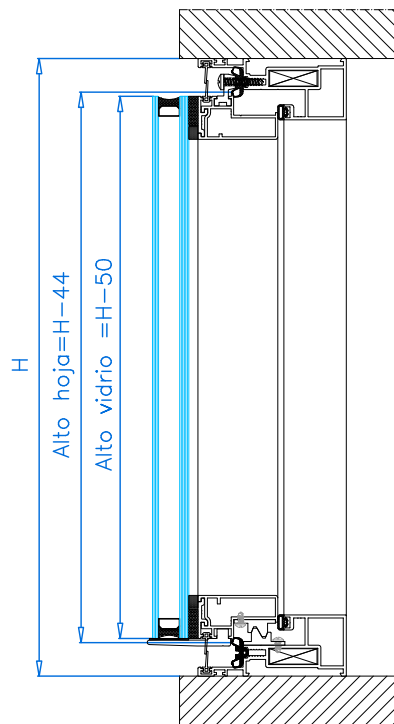
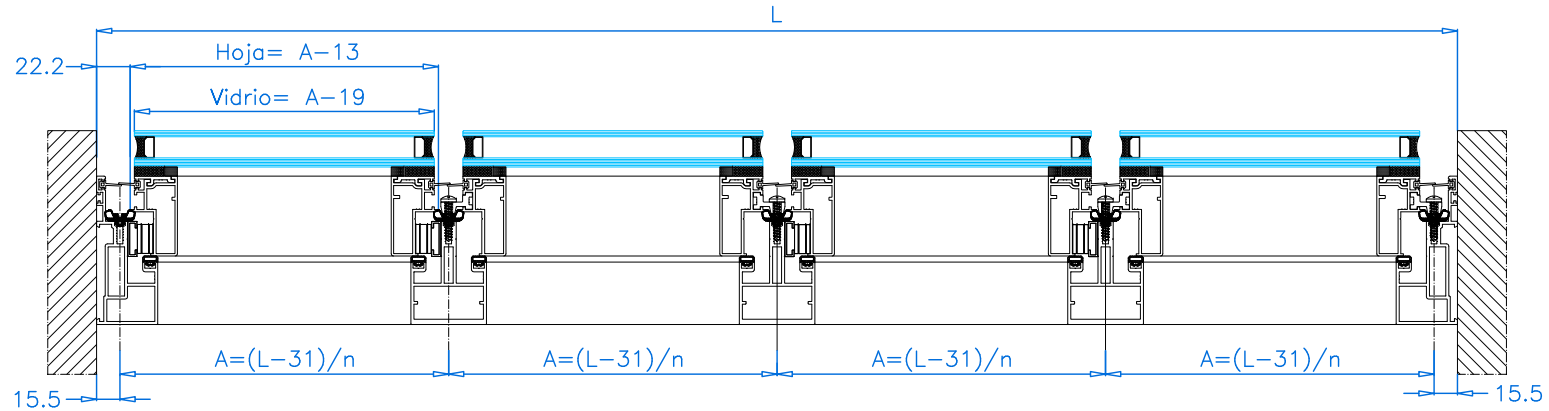

n = suma de proyectantes y fijos

PERFILES - LONGITUDES DE CORTE				ACCESORIOS		
PERFIL	DESCRIPCION	CANT.	CORTE	REFERENCIA	DESCRIPCION	CANT.
51202	MARCO / MONTANTE 32.5x10.5	2	H	050.010.1	ESCUADRA MEDIO MONTANTE	4
51202	MARCO / MONTANTE 32.5x10.5	2	L	050.013.1	ESCUADRA HOJA-FIJO	16
52001	HOJA-FIJO/ESTRUCTURAL	8	$(L-31)/n - 13$	50.01.04/6	JUEGO COMPAS REG. 60/120 KG	2
52001	HOJA-FIJO/ESTRUCTURAL	8	H-44	50.01.05/7	KIT DE FIJACION COMPAS 60/120KG	2
51002	MONTANTE 20x40	3	H-80	50.01.09	CIERRE PRESION DERECHA	2
				50.01.10	CIERRE PRESION IZQUIERDA	2
				50.01.03	CERRADERO	4
				050.662.5	TORNILLO FIJACION APOYO GUIA 050.683.1	8
				050.663.5	TORNILLO FIJACION TRAVESAÑO 050.690.2	12
				050.664.5	TORNILLO FIJACION CALZO 050.686.1	16
				050.665.5	TORNILLO FIJACION SOPORTE 050.682.1	16
				050.682.1	SOPORTE FIJACION	16
				050.683.1	JUEGO APOYO GUIA	4
				050.686.1	CALZO DE VIDRIO	8
				050.690.2	UNION MONTANTE TRAVESAÑO	6
				050.691.2	SOPORTE FIJACION	6
				050.831.6	JUNTA CIERRE CENTRAL	---
				050.832.6	JUNTA PERIMETRAL	---
				050.833.6	JUNTA BATIENTE	---

Sections - *Secciones*

- PASO DE FORJADO MURO CORTINA ESTRUCTURAL -

