

STICK CURTAIN WALL MURO TAPETA

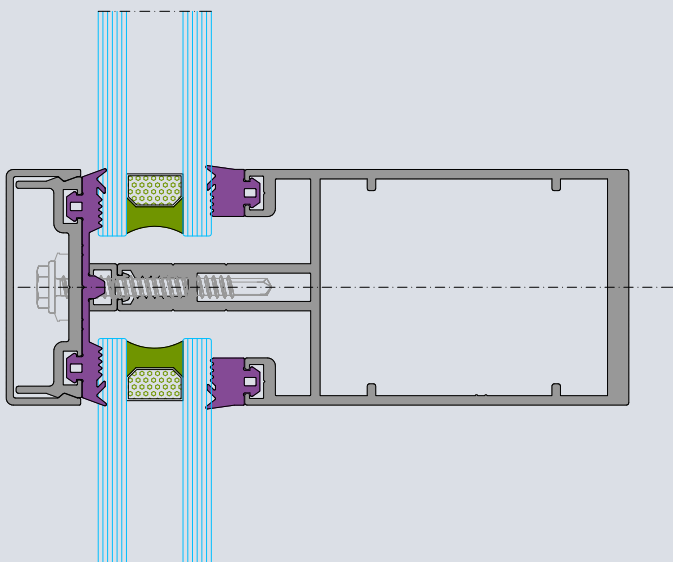

MORE INFORMATION - MÁS INFORMACIÓN

Visit our website for more information of this series and to download the documentation in pdf format.

Visite nuestra página web para una mayor información de esta serie y poder descargar la documentación en formato pdf.

www.gruposopena.com



Sections

Secciones

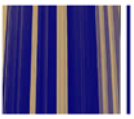

Sections - *Secciones*

- SECCION HORIZONTAL FIJOS -

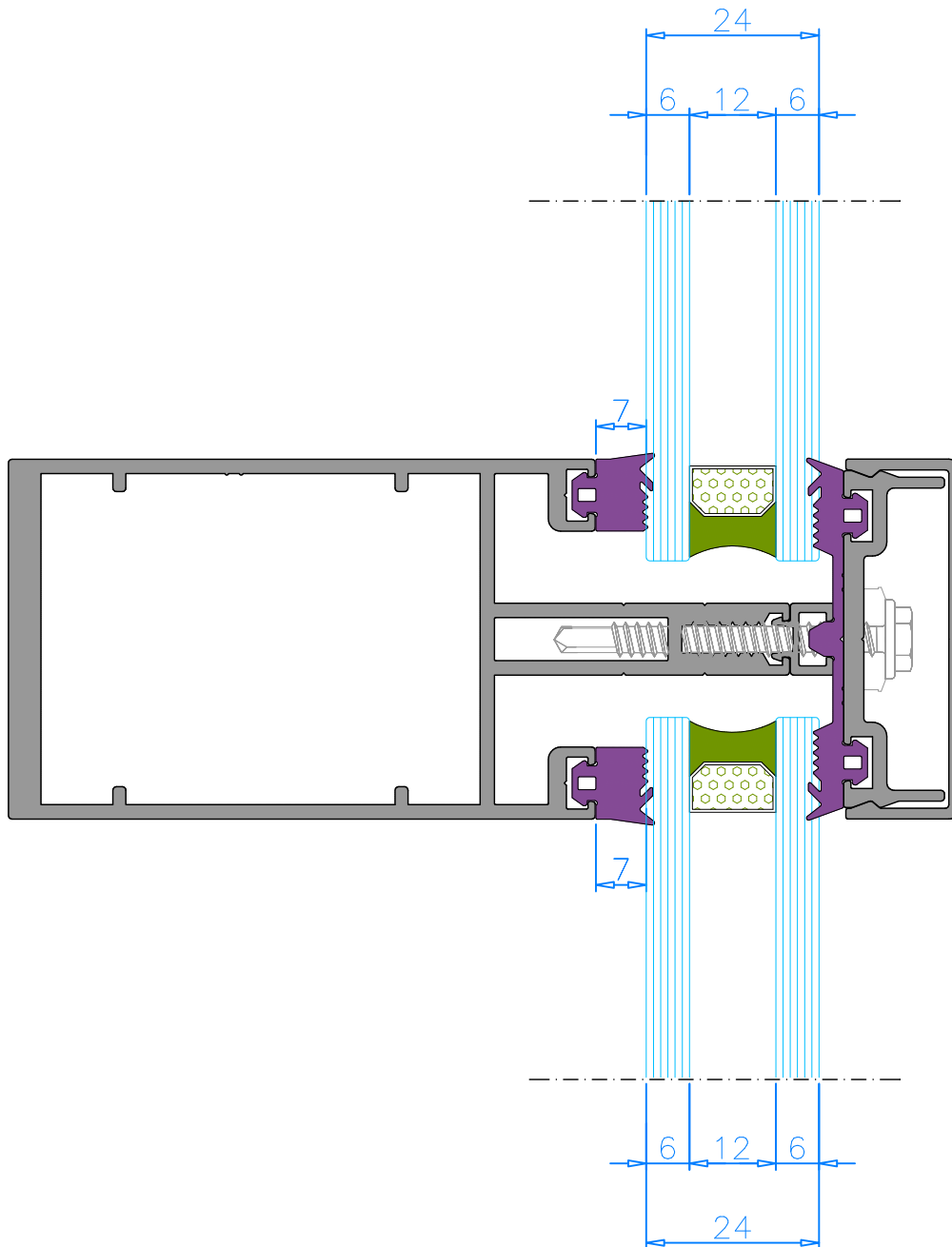



Sections - *Secciones*

- SECCION VERTICAL FIJOS -

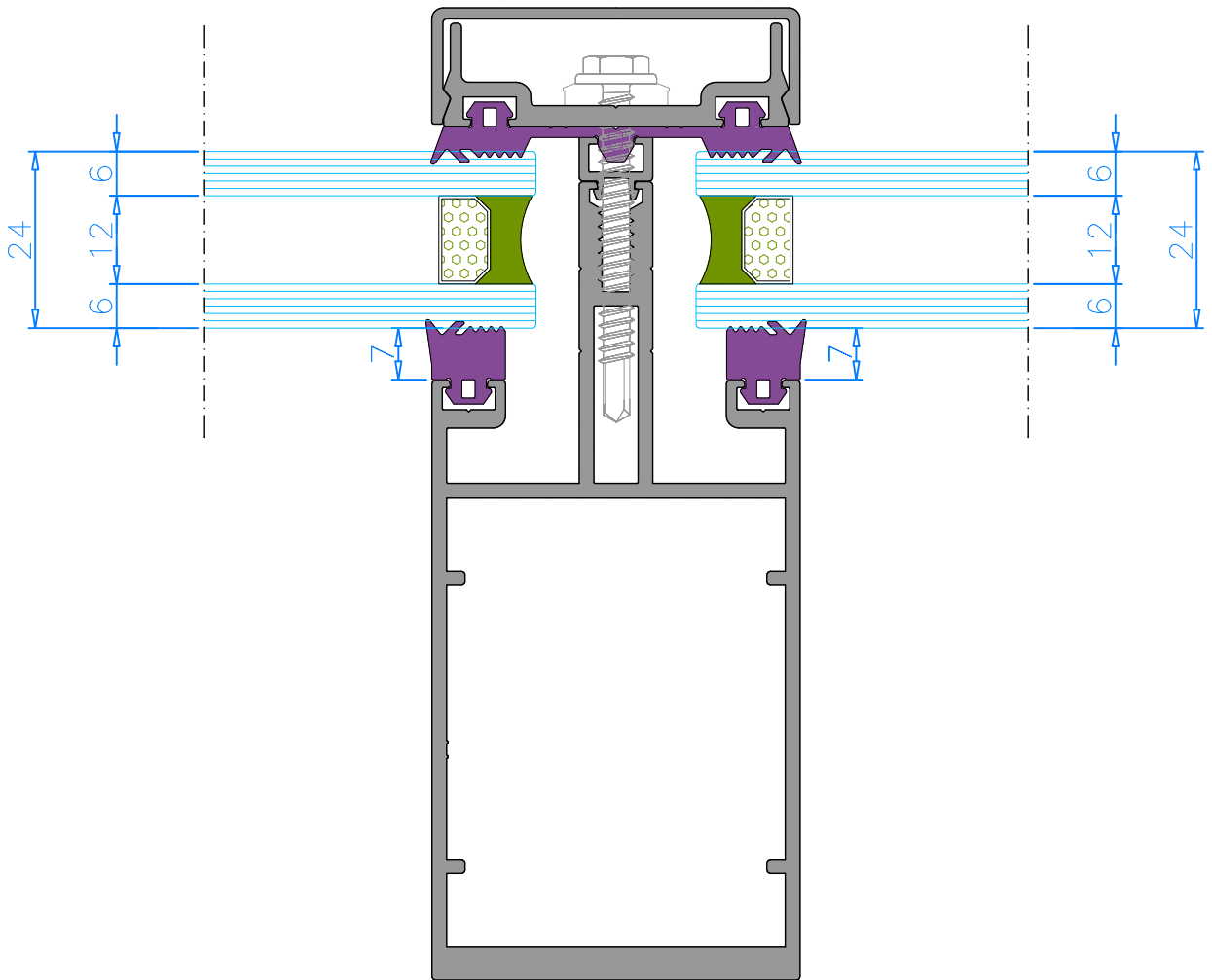

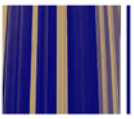

Sections - *Secciones*

- SECCION VERTICAL PROYECTANTE -

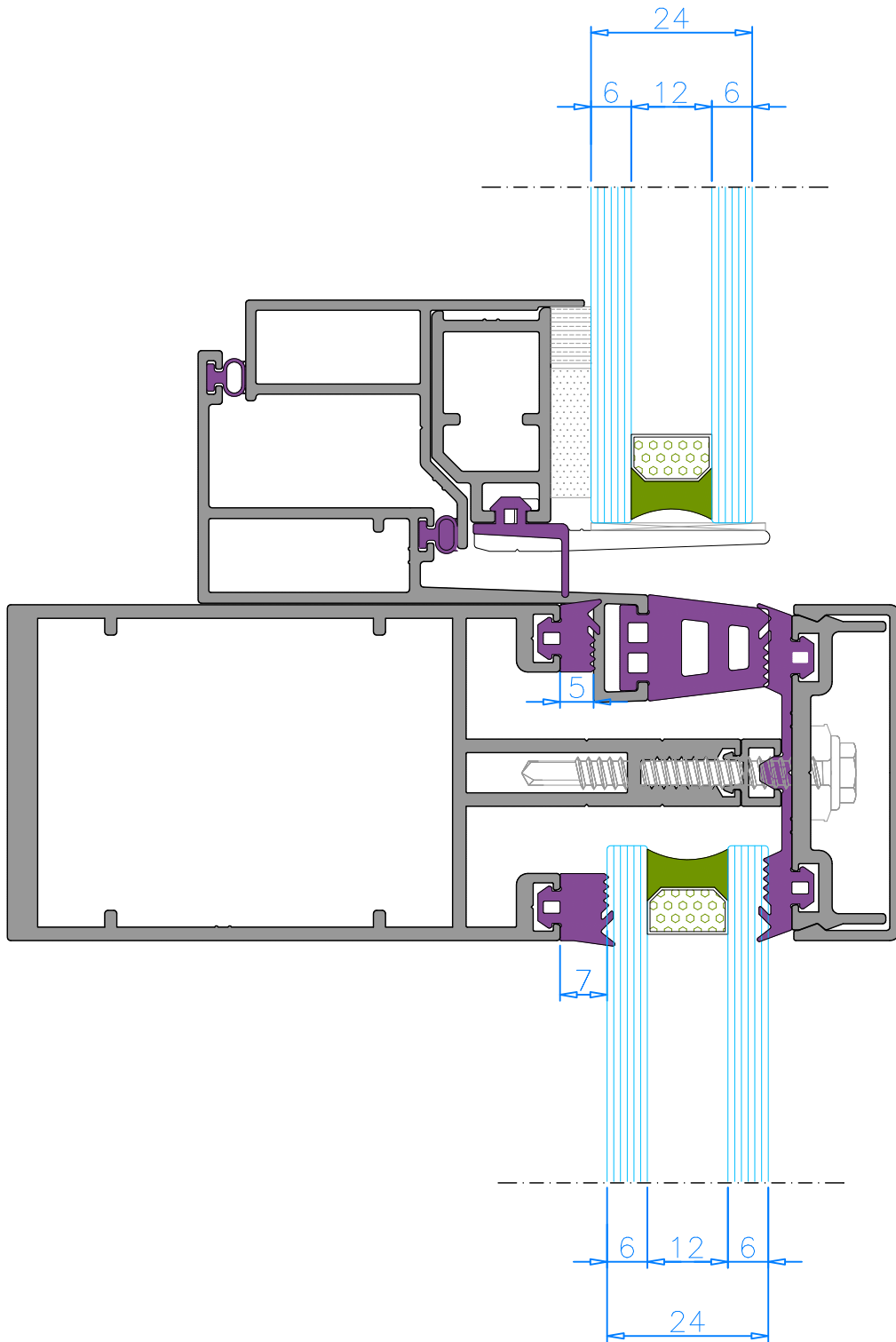



Sections - *Secciones*

- SECCION HORIZONTAL PROYECTANTE -

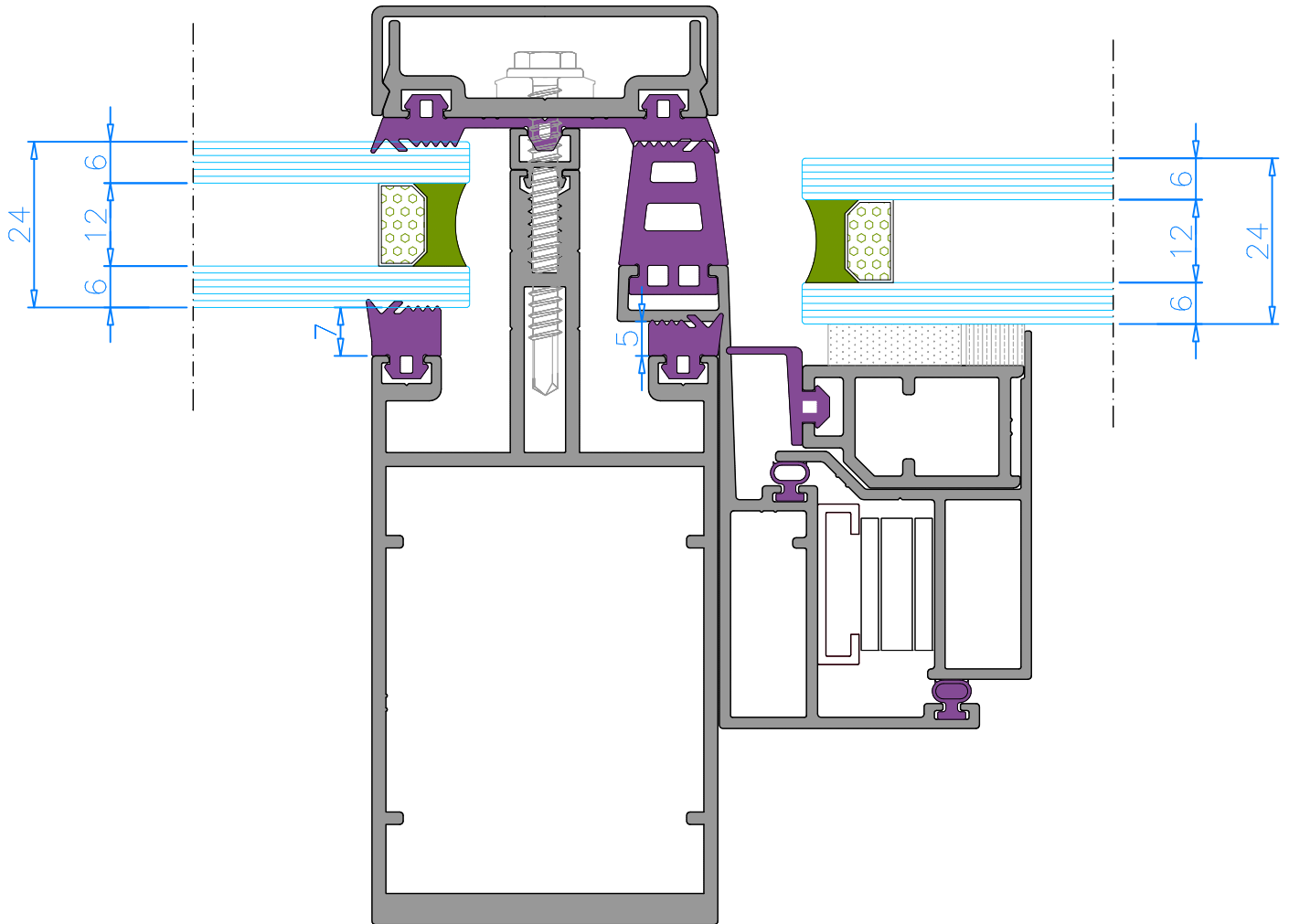

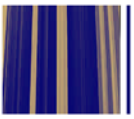

Sections - *Secciones*

- REMATE A PARED -

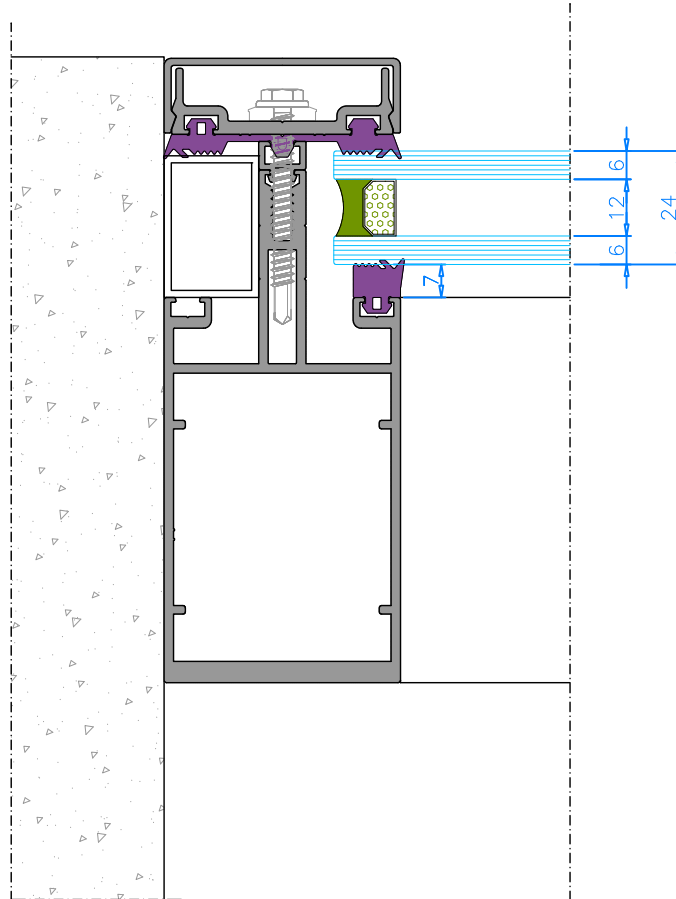

TRC30X20

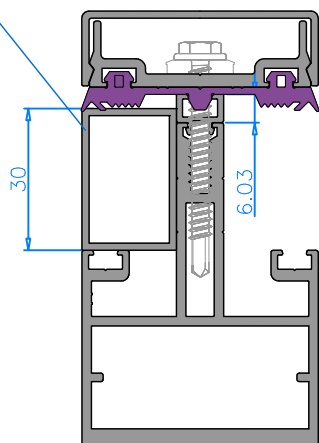

TRC40X20

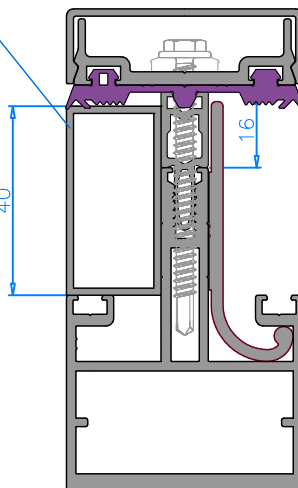

TRC50X20

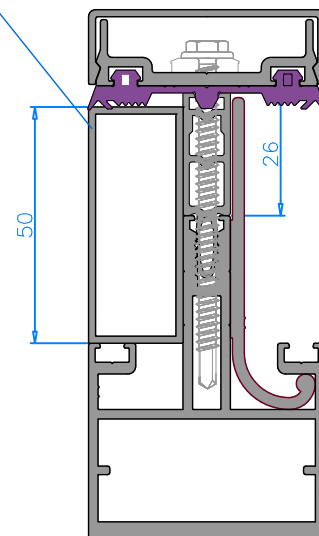

- REMATE A PARED, DEPENDIENDO DEL INTERCALARIO QUE SE MONTE -

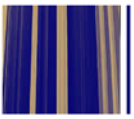

Sections - *Secciones*

- ANCLAJE AL SUELO -

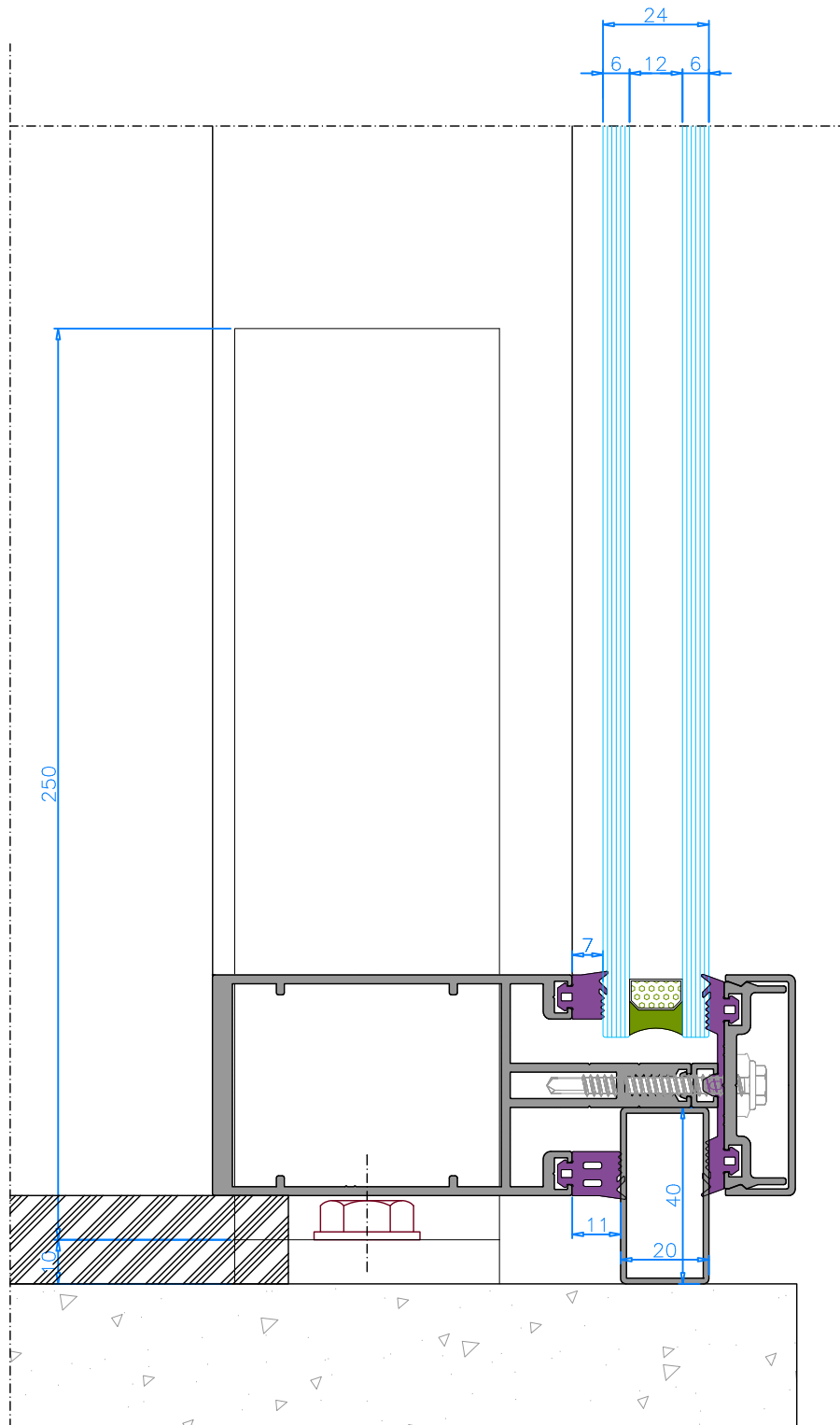

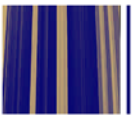

Sections - *Secciones*

- ANCLAJE AL SUELO -

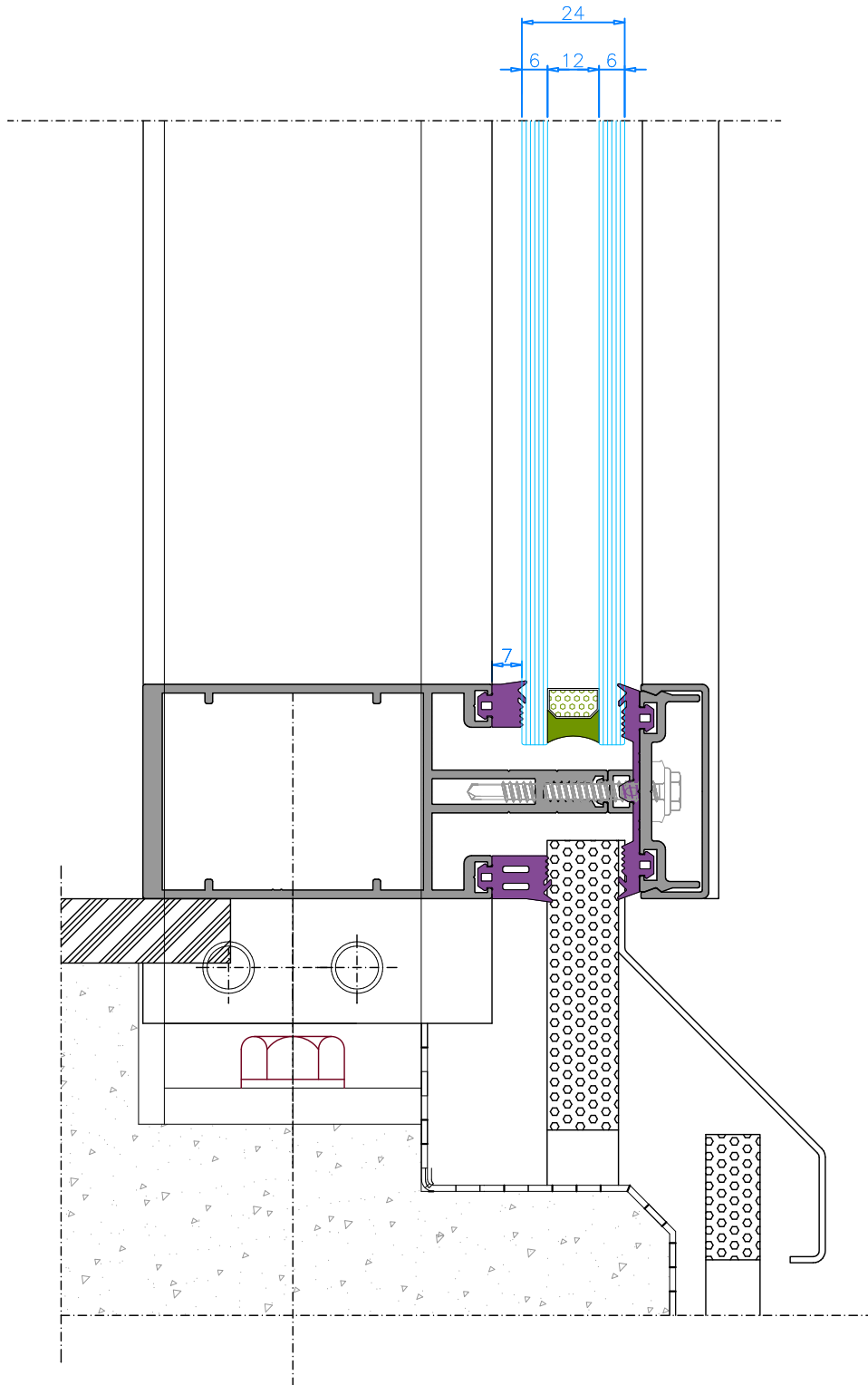



Sections - *Secciones*

- ANCLAJE AL TECHO -

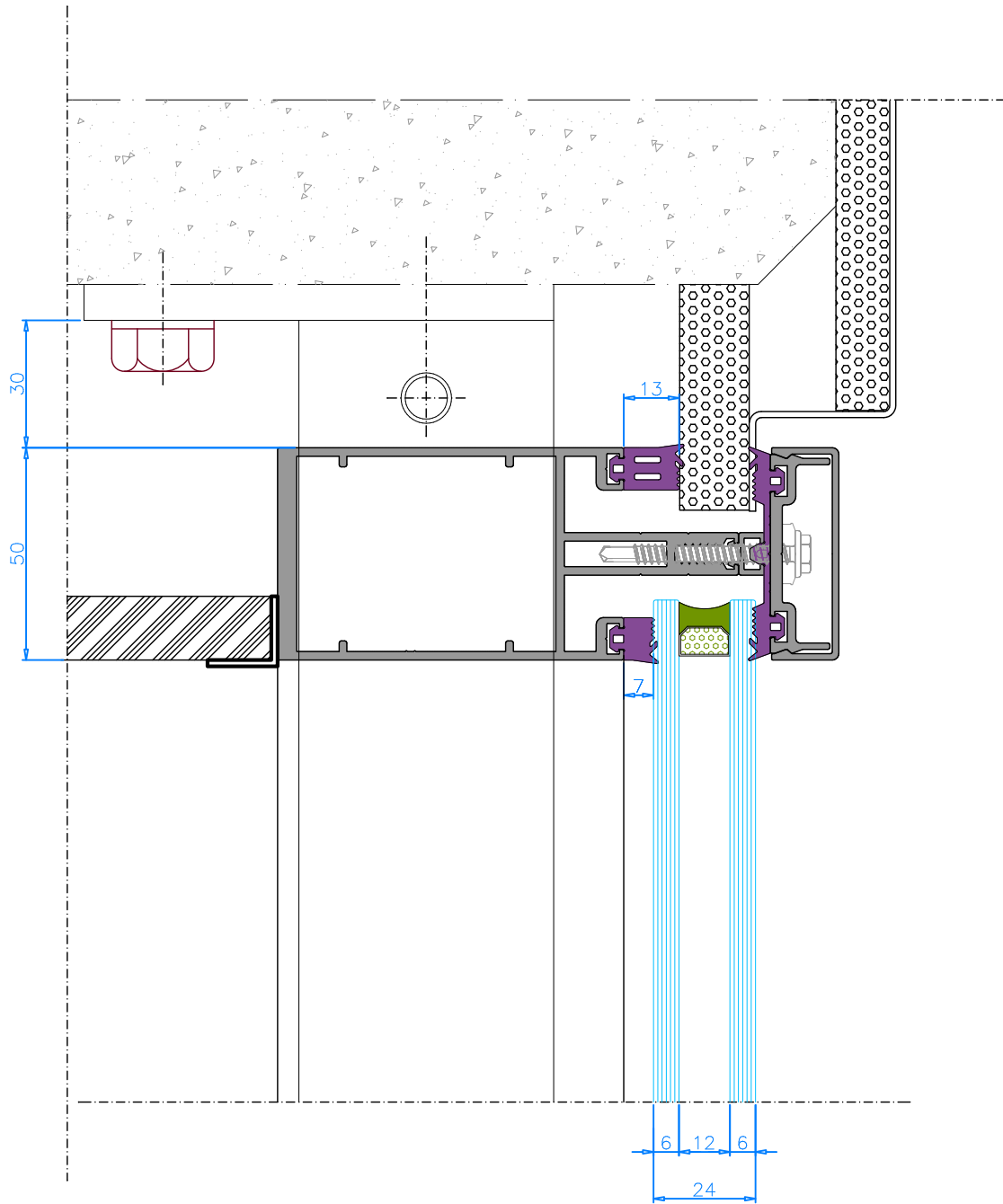



Sections - *Secciones*

- REMATE SUPERIOR -

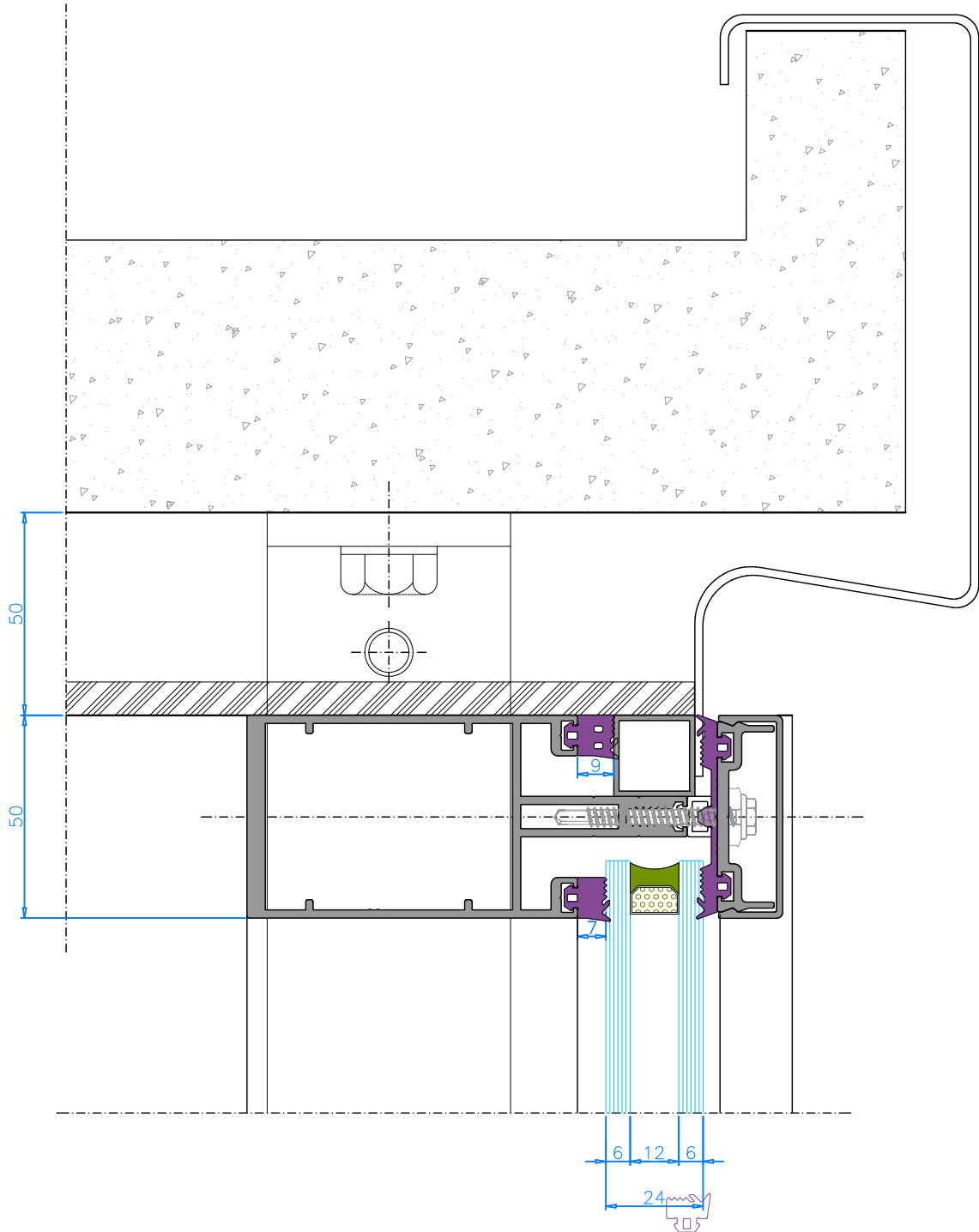



Sections - *Secciones*

- SECCIÓN CON VENTANA V-98RT -

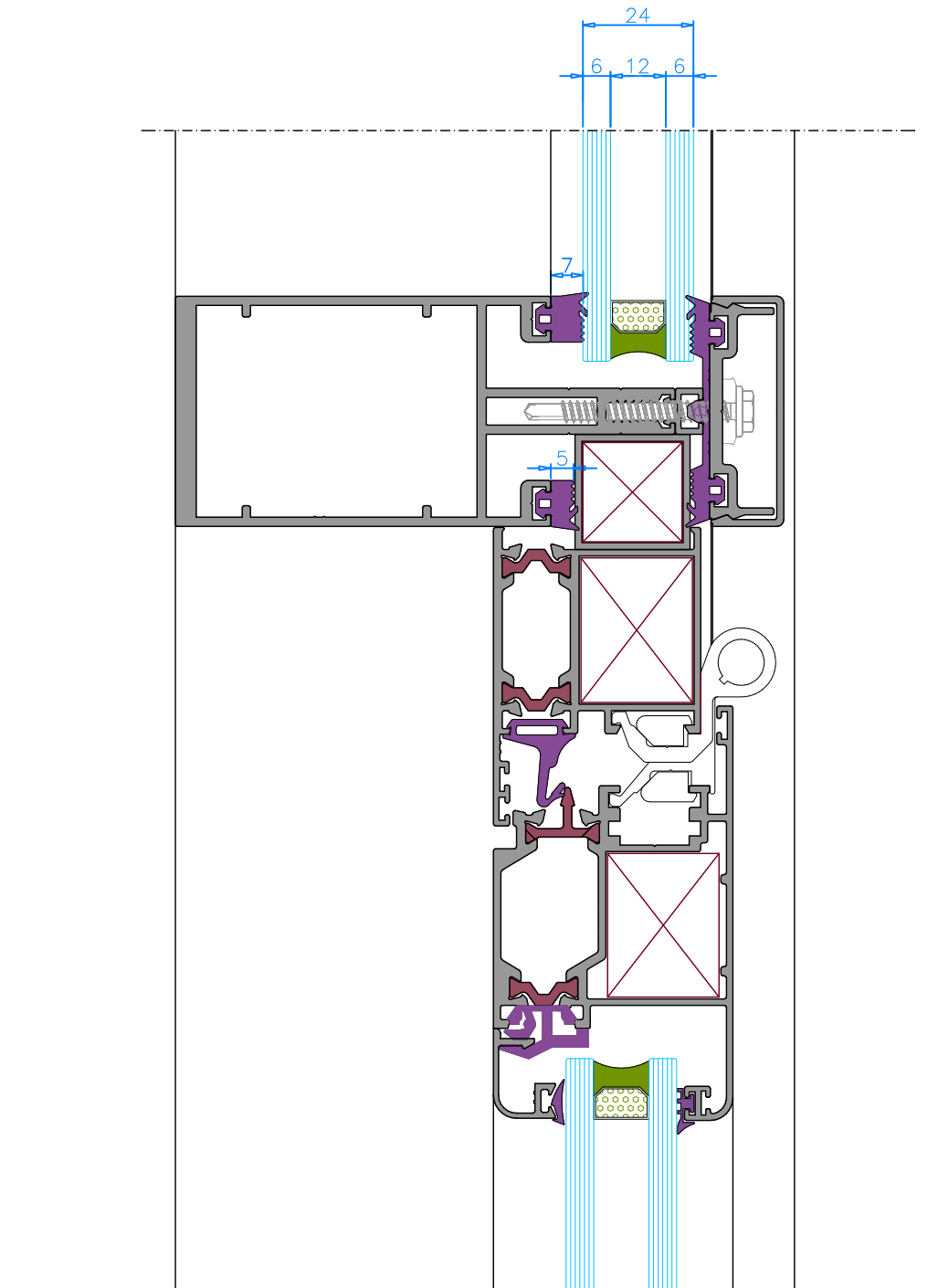

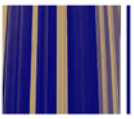

Sections - *Secciones*

- SECCIÓN CON VENTANA V-98RT -

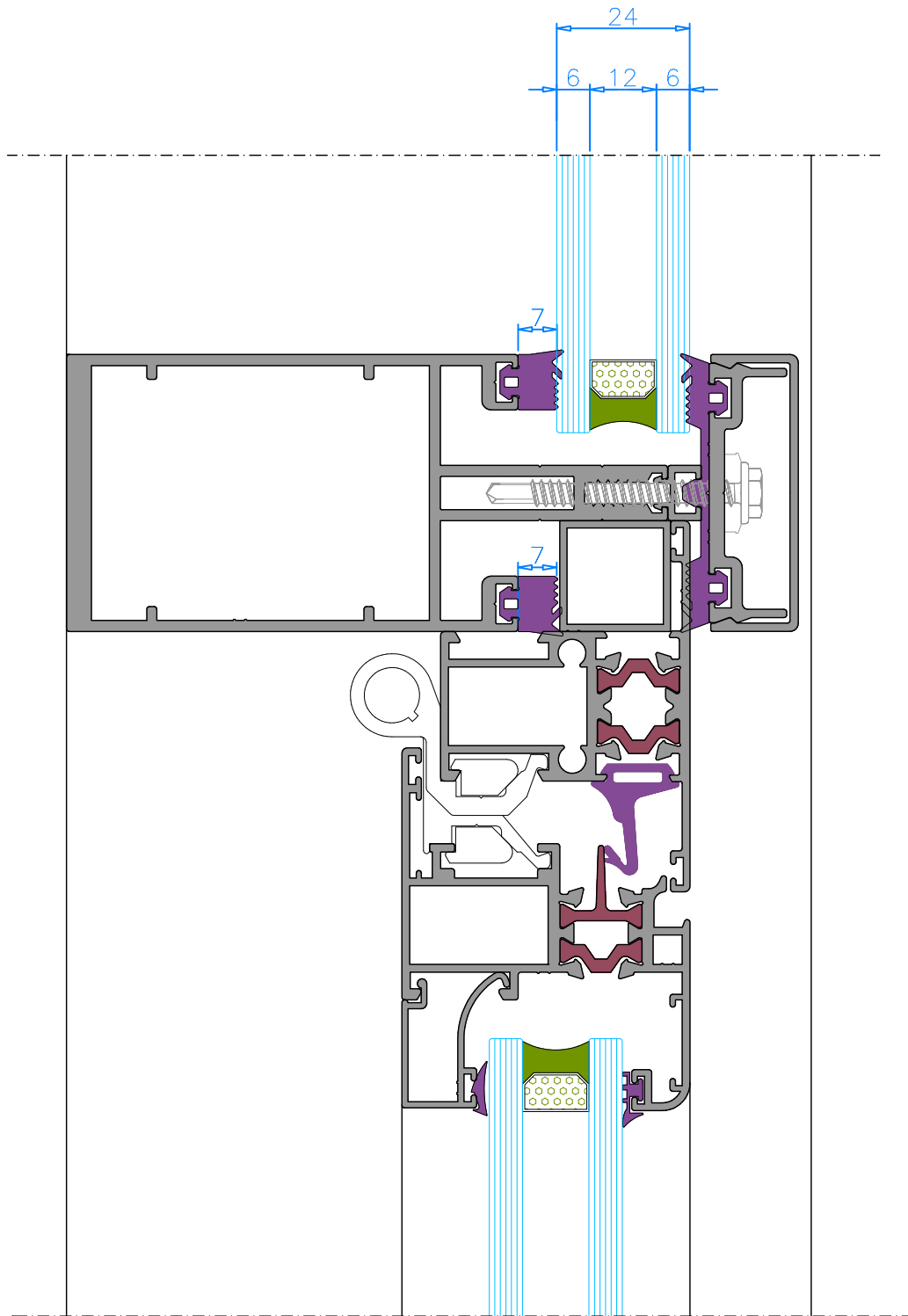

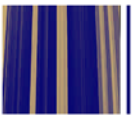

Sections - *Secciones*

- SECCIÓN CON PUERTA P-50 -

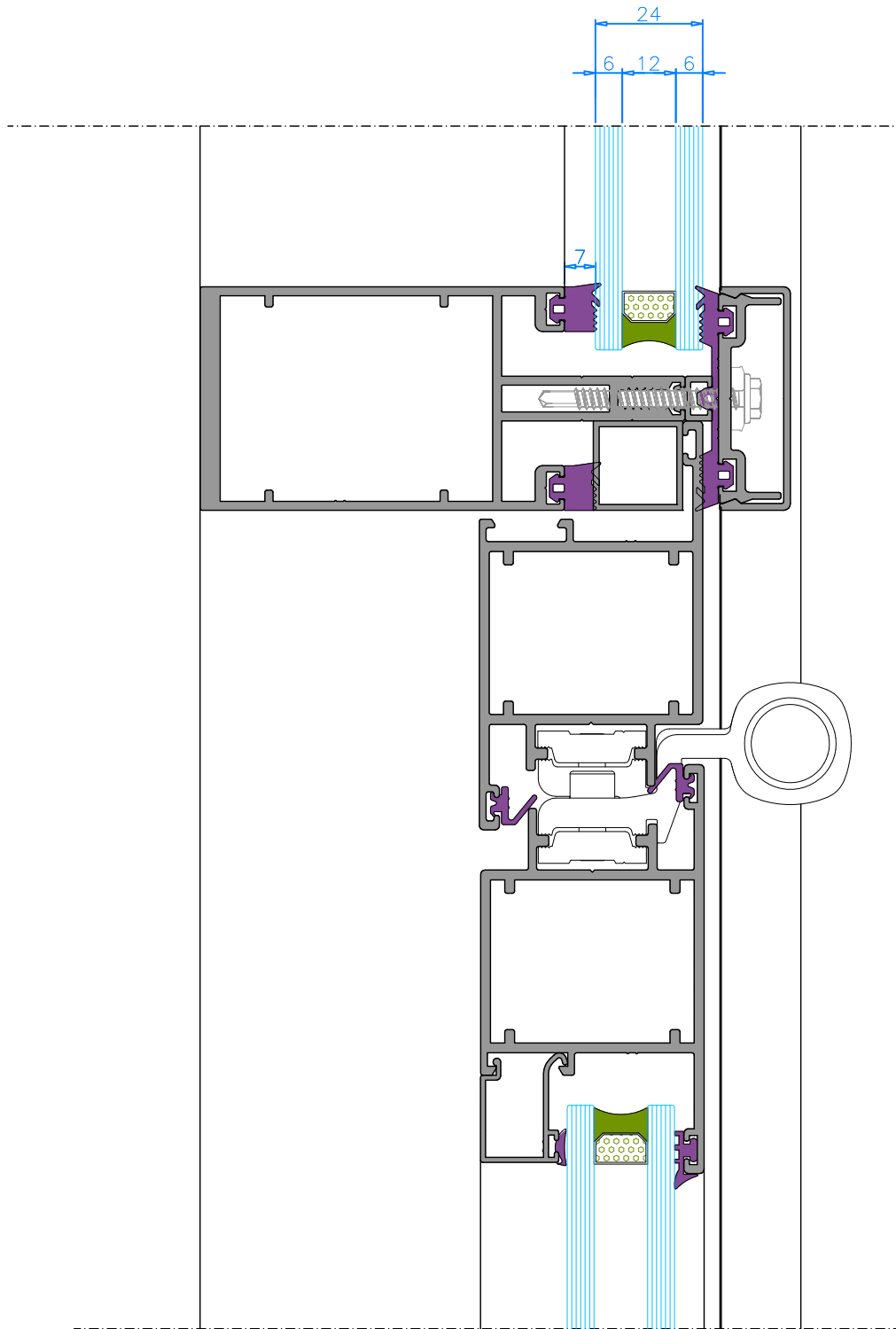

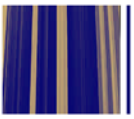

Sections - *Secciones*

- SECCIÓN HORIZONTAL FIJOS -

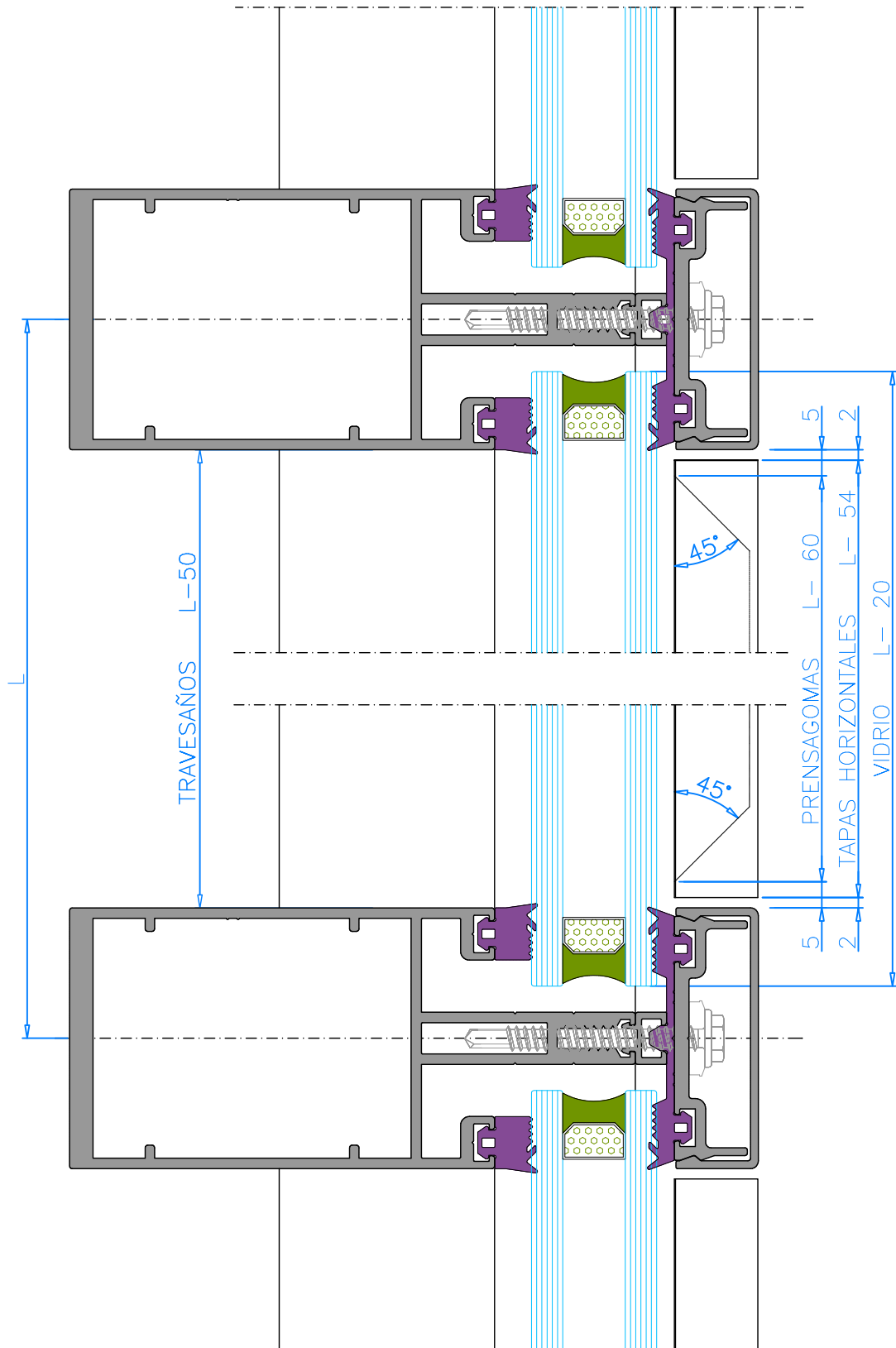

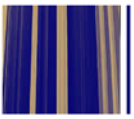

Sections - *Secciones*

- SECCIÓN VERTICAL PROYECTANTE -

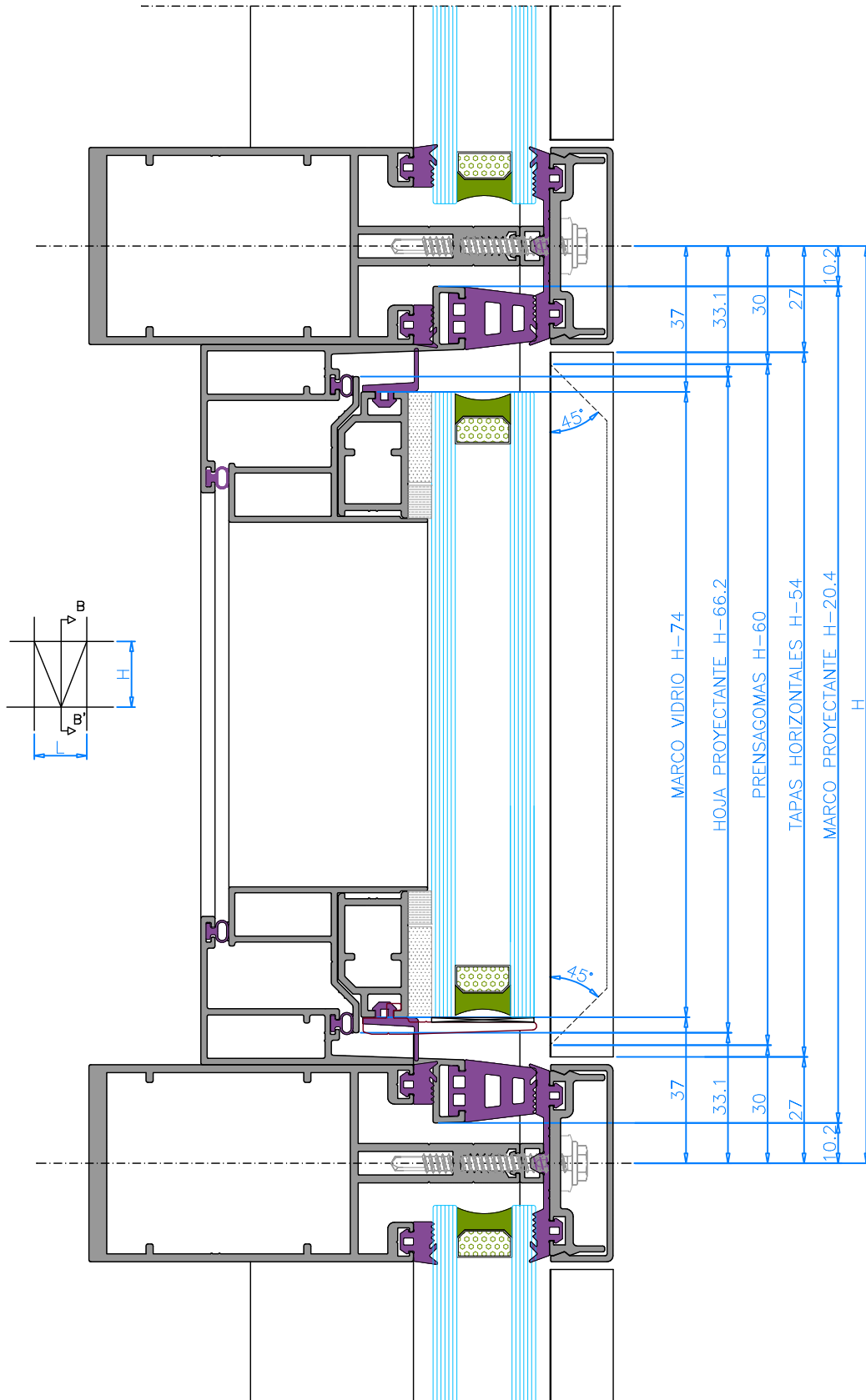

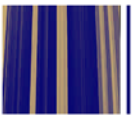

Sections - *Secciones*

- SECCIÓN HORIZONTAL PROYECTANTE -

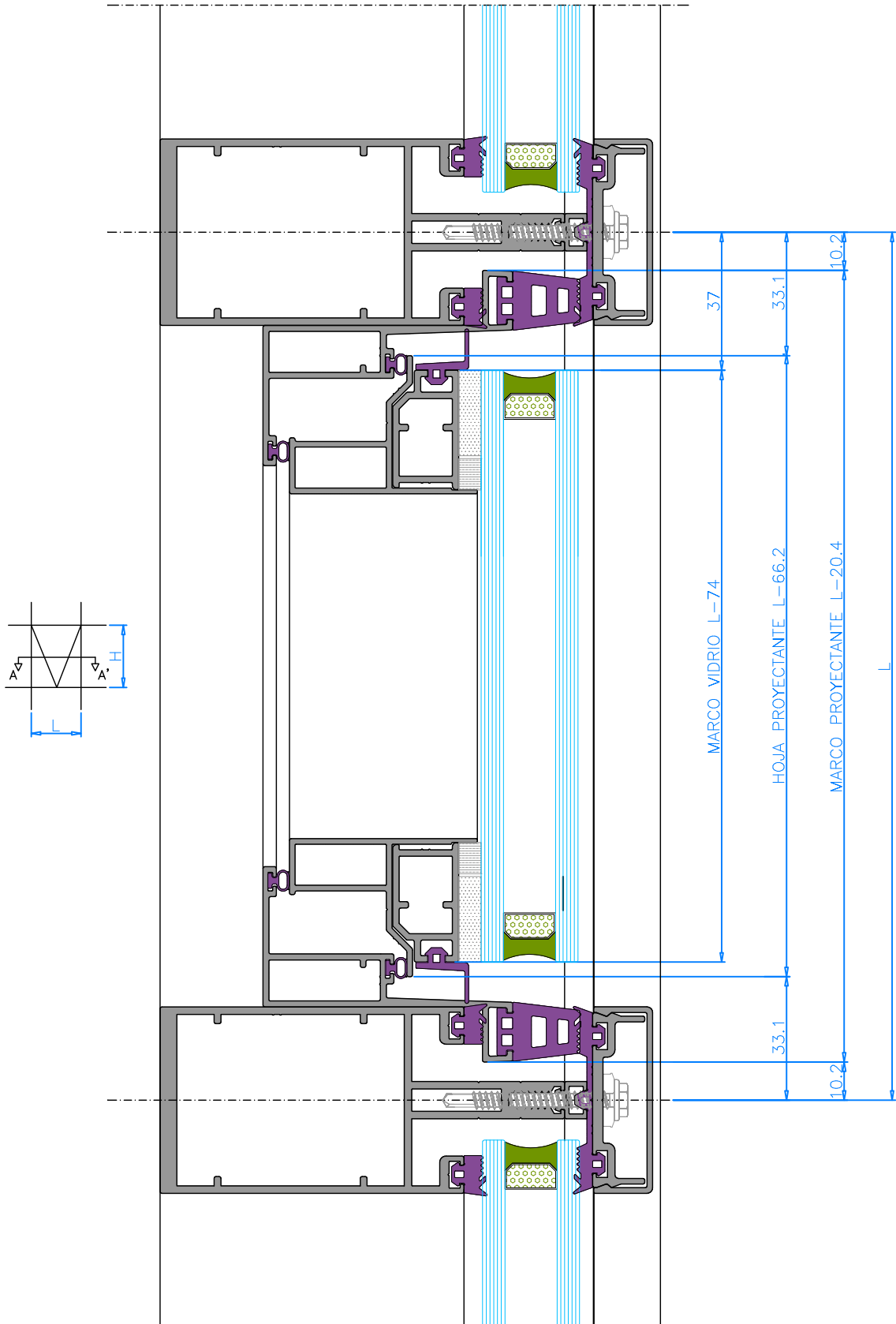

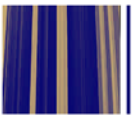

Sections - *Secciones*

- NUDO INTERIOR VENTANA PROYECTANTE -

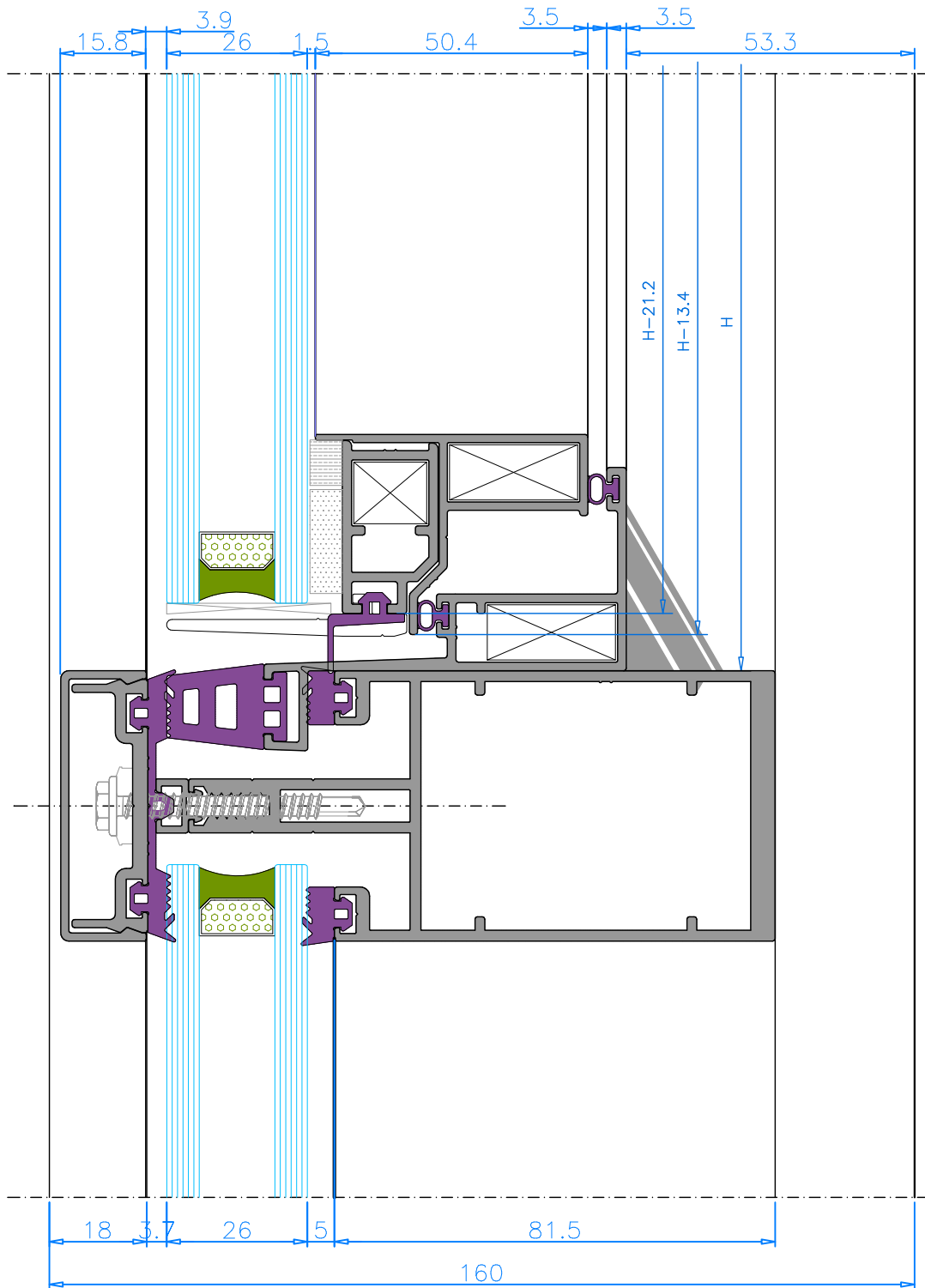

7i m]b['gVYa Yg - 7cfhY

- PASO DE FORJADO MURO CORTINA TAPETA -

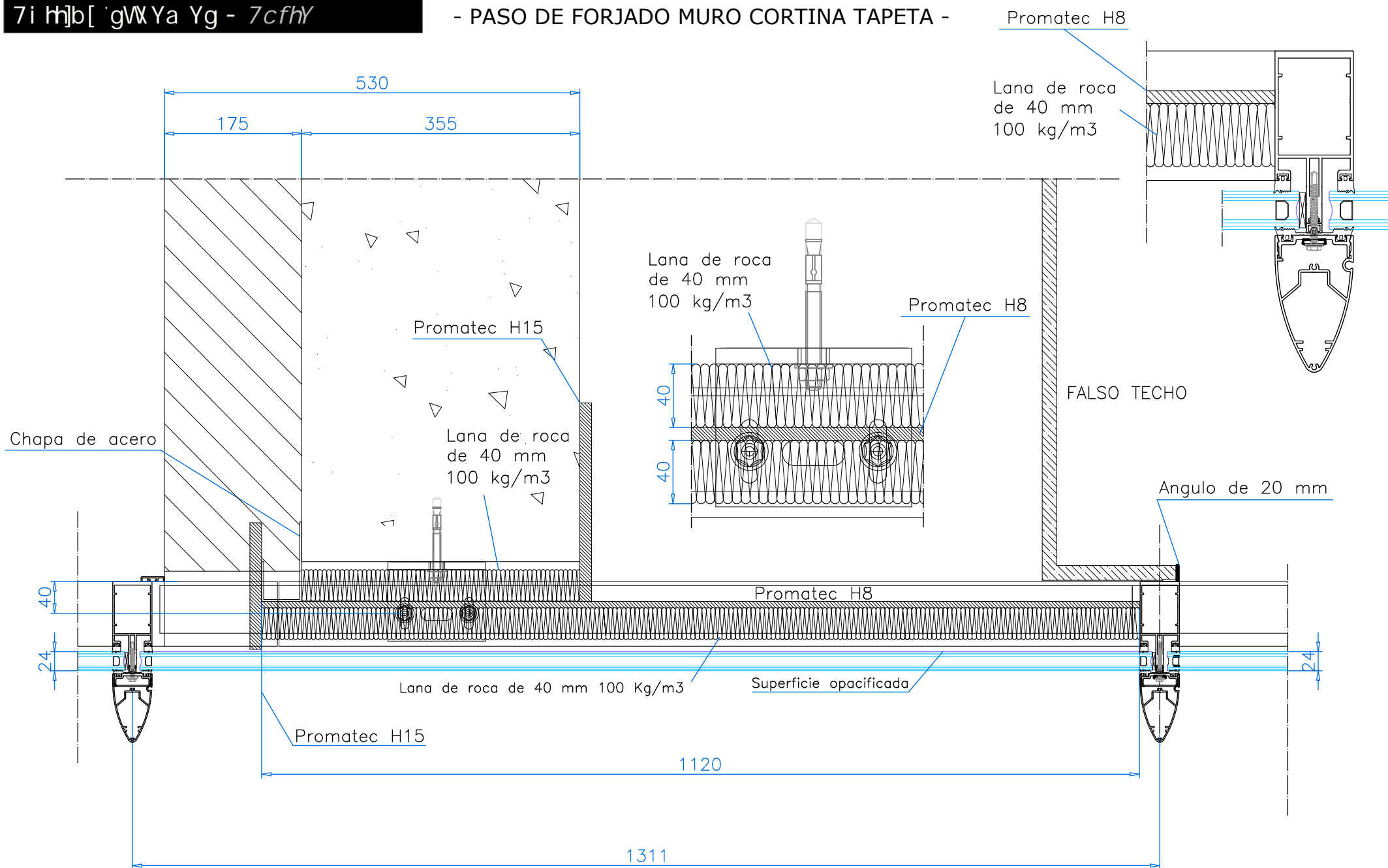

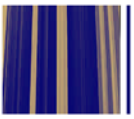

Sections - *Secciones*

- MONTAJE MONTANTE TRAVESAÑO -

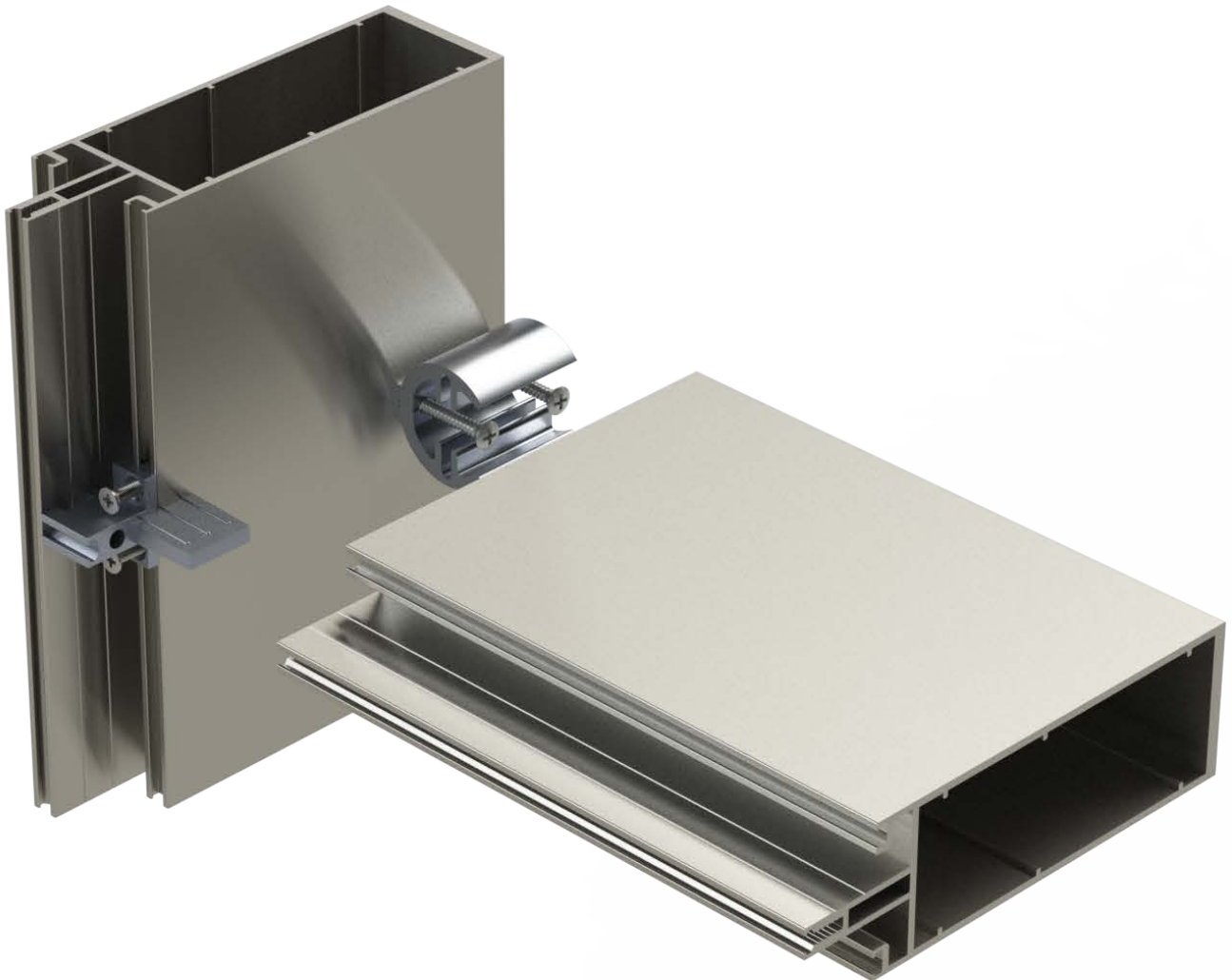



Glazing

Acristalamiento

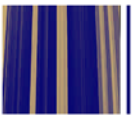

Glazing - Acristalamiento



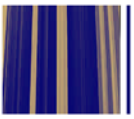

Glazing - *Acristalamiento*

- CON SUPLEMENTO 54533 -

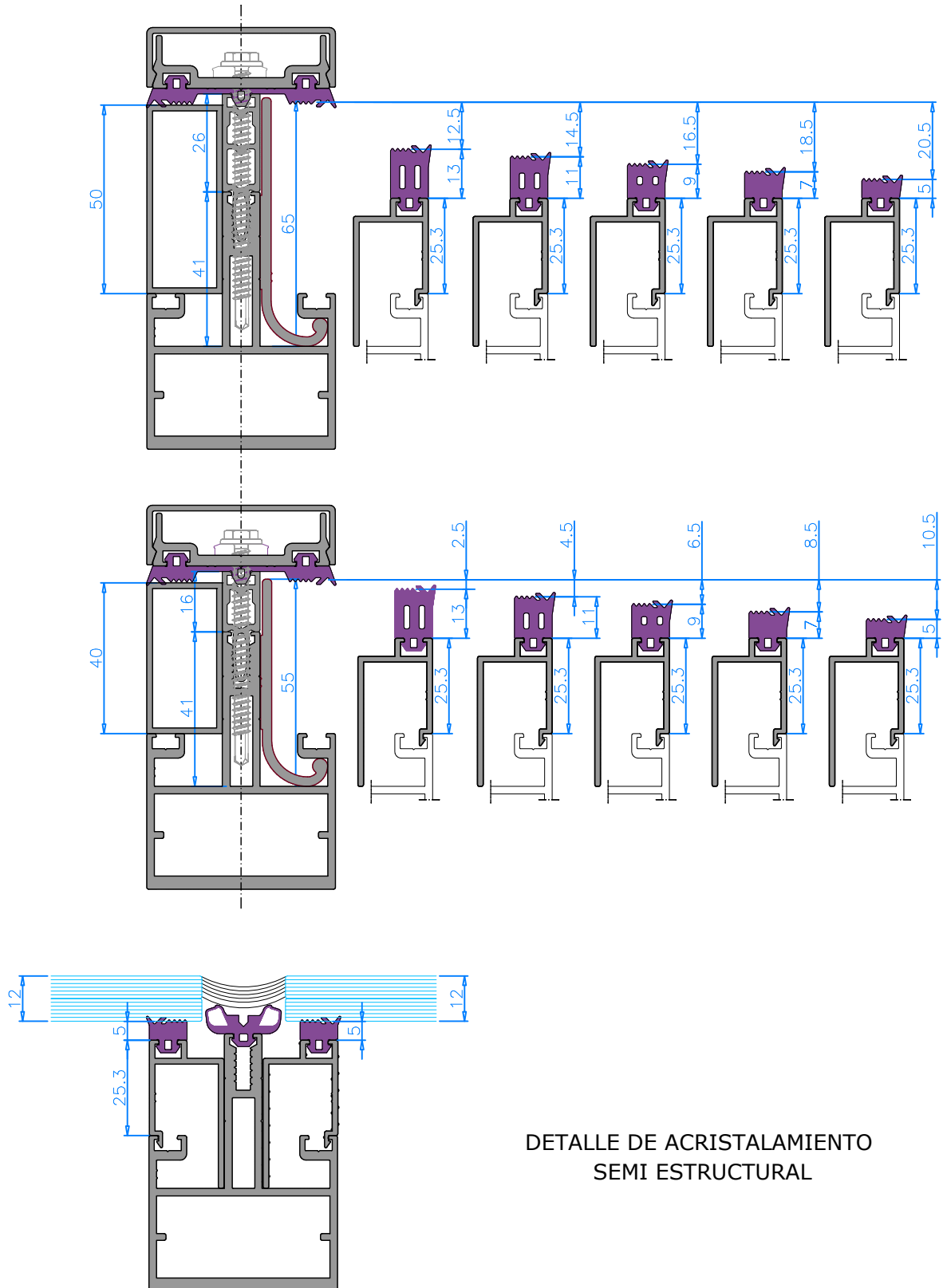

DETALLE DE ACRISTALAMIENTO
SEMI ESTRUCTURAL