

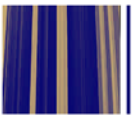

# Profiles

## *Perfiles*



Profiles - *Perfiles*

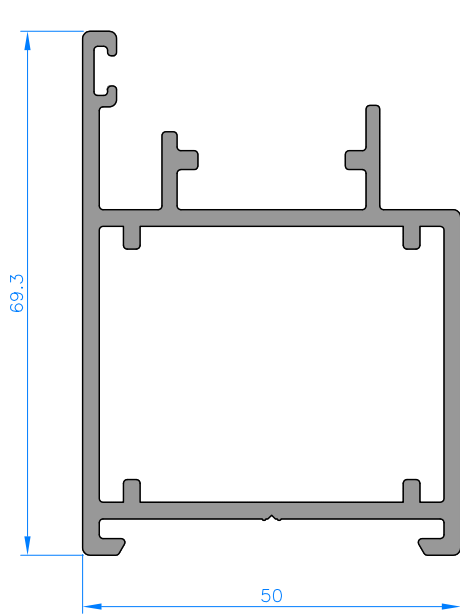

5010

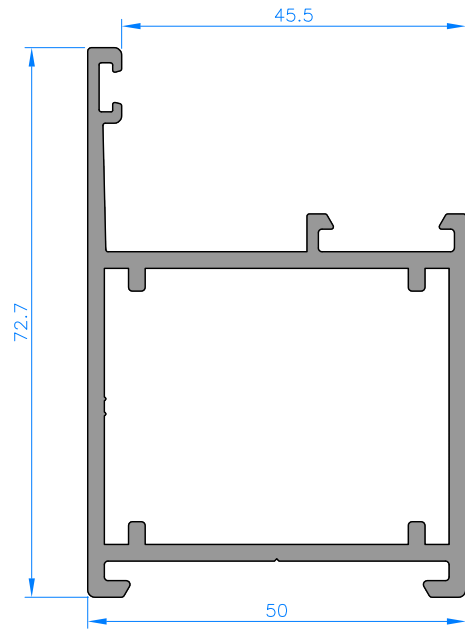

5011

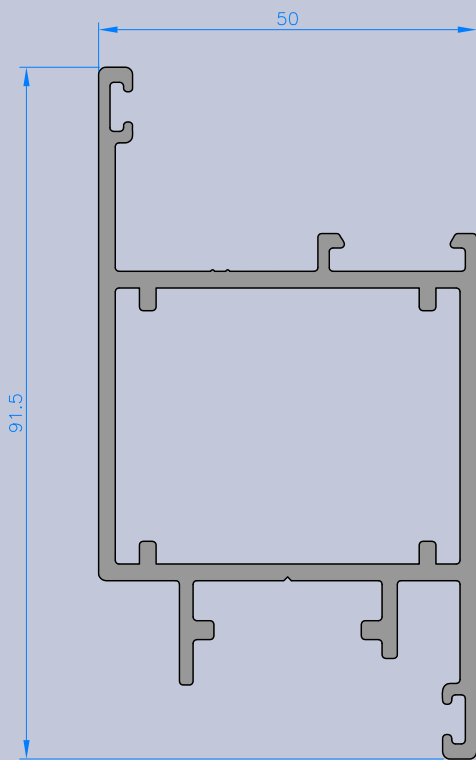

5020

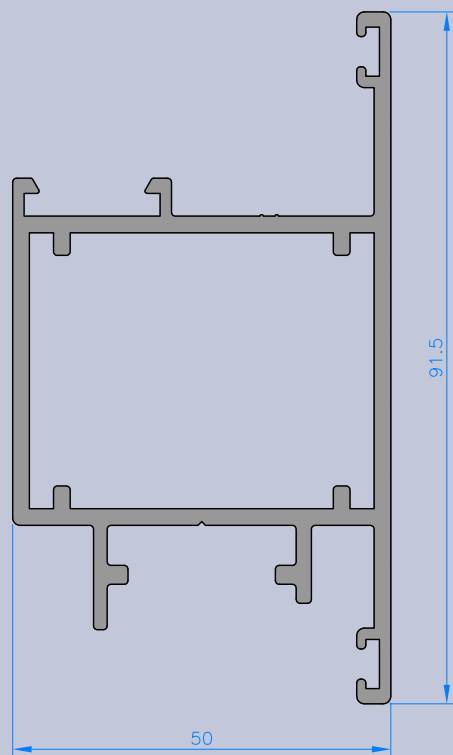

5030



Profiles - *Perfiles*

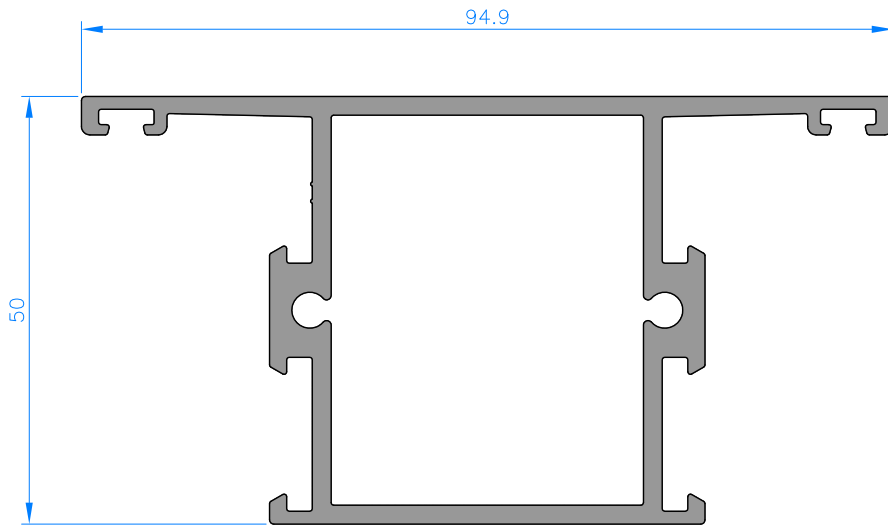

5031

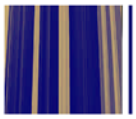

Profiles - *Perfiles*

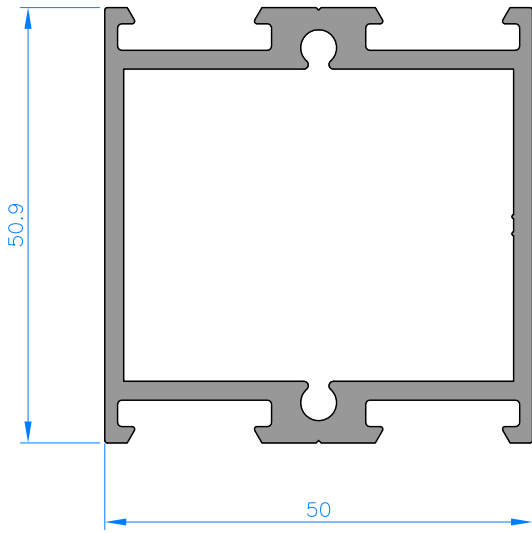

5040

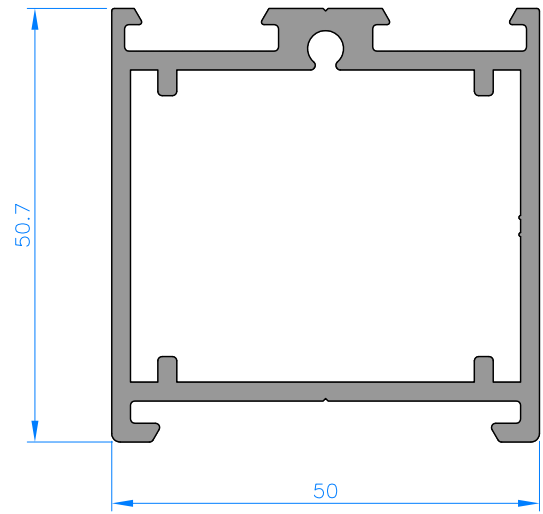

5041

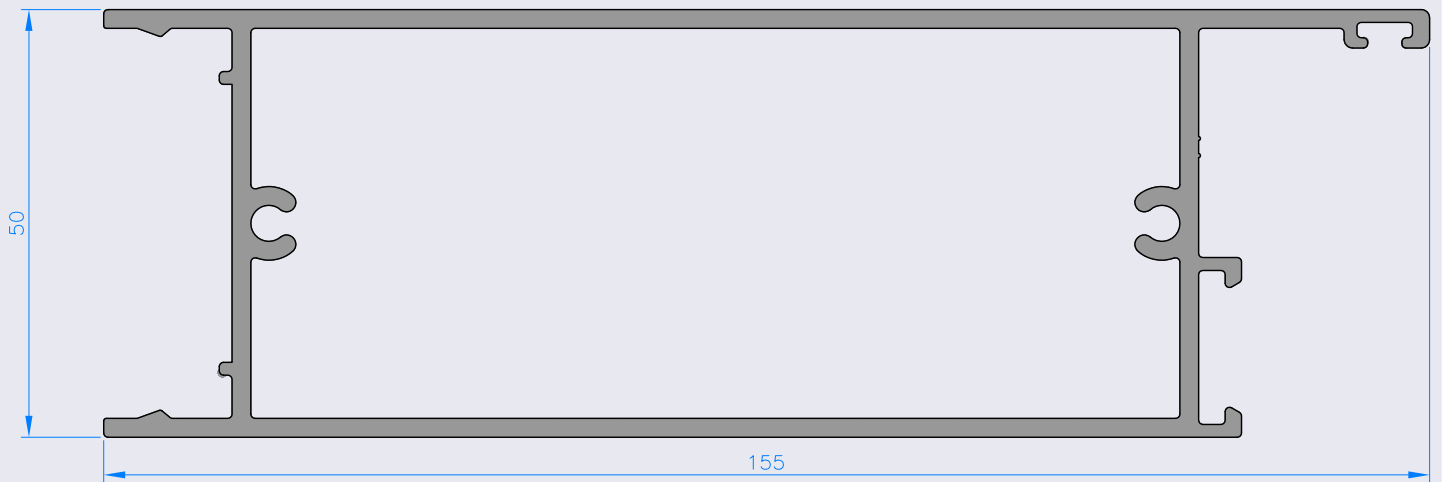

5050

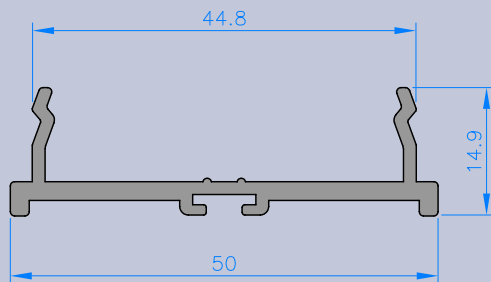

5401

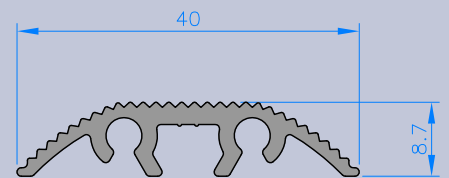

5402



Profiles - *Perfiles*

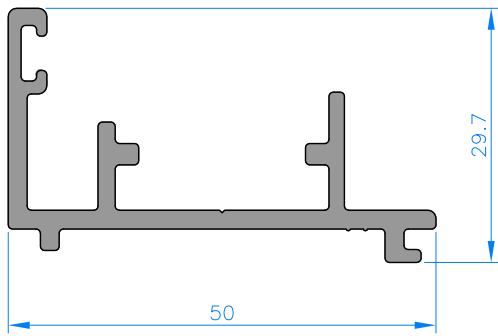

5403

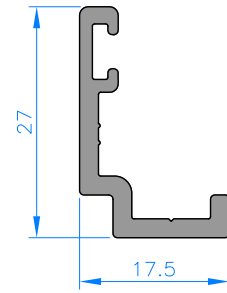

5404

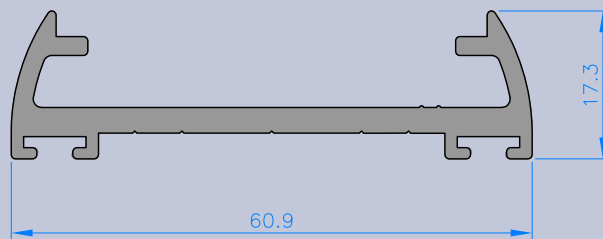

5407



Profiles - *Perfiles*

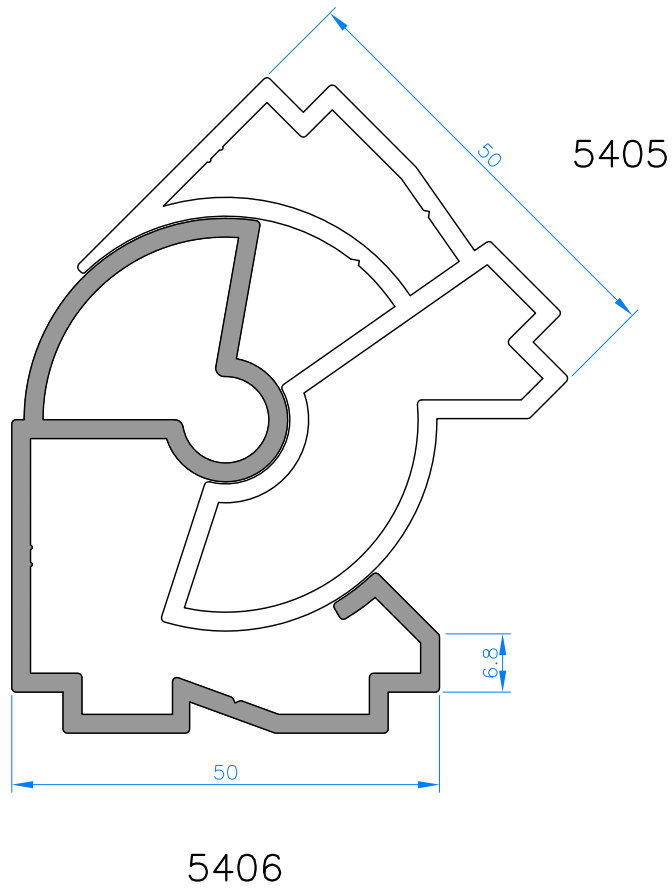

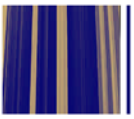

Profiles - *Perfiles*

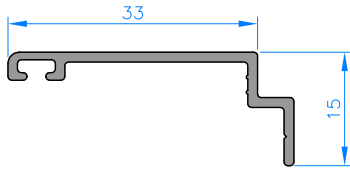

72701

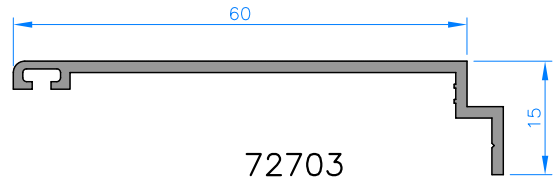

72703

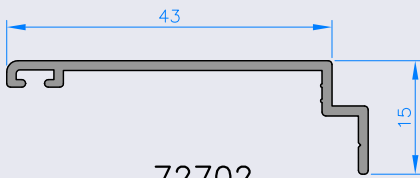

72702

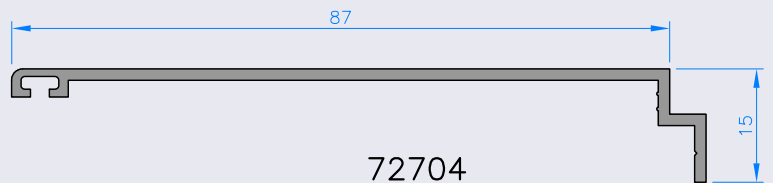

72704

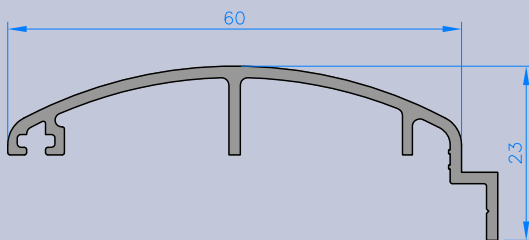

72708

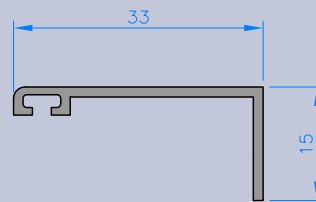

72800\*

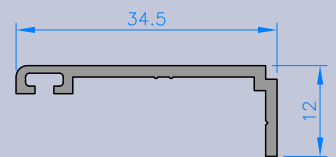

72801

\* Consultar existencias o pedido mínimo

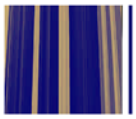

## Profiles - Perfiles

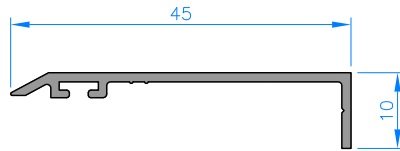

72802

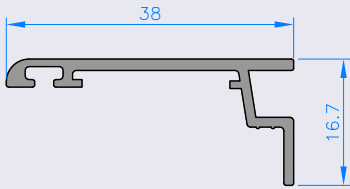

72804

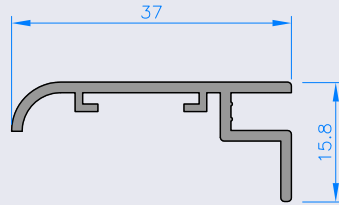

72803

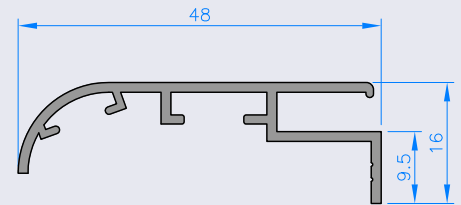

72481

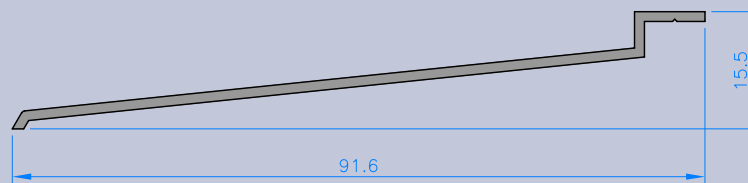

4657\*

\* Consultar existencias o pedido mínimo





# Glazing

## *Acristalamiento*

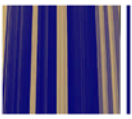

## Glazing - Acristalamiento

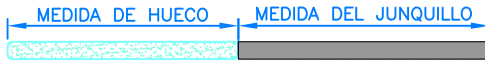

Para calcular el vidrio:  
Descontar la medida de juntas, según indicaciones del fabricante.

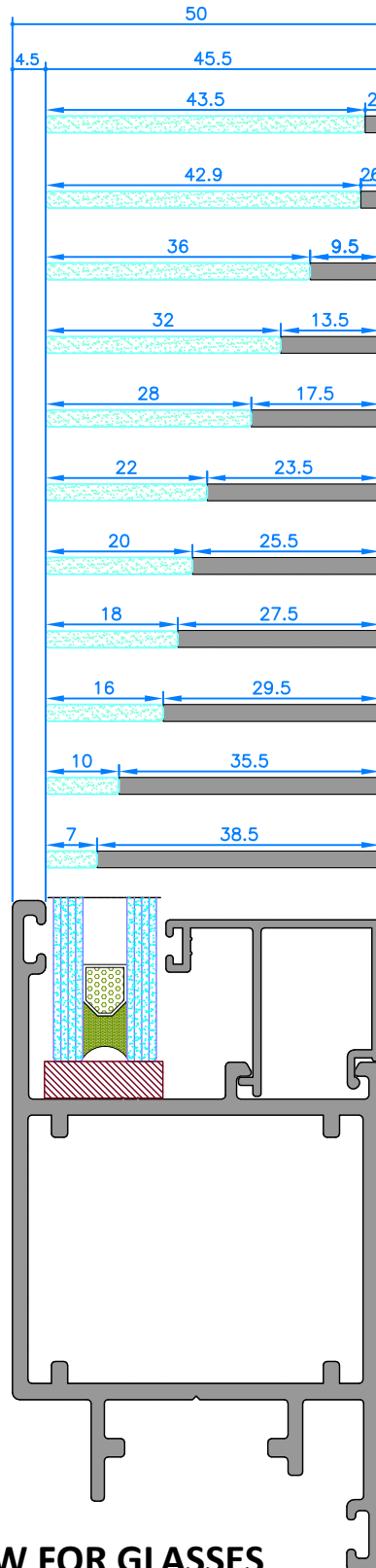

102308		
	940305	
940304	940314	940324
940303	940313	940323
940302	940312	940322
940301	940311	940321
940306		
850307		
940300	940310	940320
980302		
980301		

9998216		3 MM FIN EXT. GLAZING JOINT JUNTA ACRISTALAMIENTO EXTERIOR DE 3 MM.
9998226		6 MM FIN EXT. GLAZING JOINT JUNTA ACRISTALAMIENTO EXTERIOR DE 6 MM.
9998236		3 MM FIN INT. GLAZING JOINT JUNTA ACRISTALAMIENTO DE CUÑA DE 3 MM.
9998246		4 MM FIN INT. GLAZING JOINT JUNTA ACRISTALAMIENTO DE CUÑA DE 4 MM.
9998256		5 MM FIN INT. GLAZING JOINT JUNTA ACRISTALAMIENTO DE CUÑA DE 5 MM.
9998266		6/7 MM FIN INT. GLAZING JOINT JUNTA ACRISTALAMIENTO DE CUÑA DE 6/7 MM.
9998286		8/9 MM FIN INT. GLAZING JOINT JUNTA ACRISTALAMIENTO DE CUÑA DE 8/9 MM.
9998296		10 MM FIN INT. GLAZING JOINT JUNTA ACRISTALAMIENTO DE CUÑA DE 10 MM.

**MEASURES OF HOLLOW FOR GLASSES**

**MEDIDAS DE HUECO PARA VIDRIO**







# Technical Data

## *Datos técnicos*

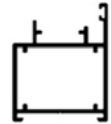
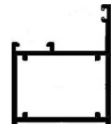
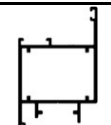
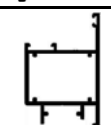
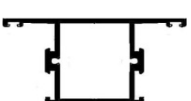
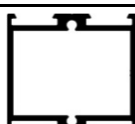
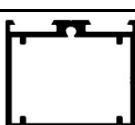
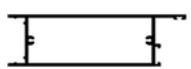





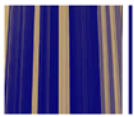

## Technical Data - *Datos técnicos*

Reference <i>Referencia</i>	Scheme <i>Esquema</i>	Description <i>Descripción</i>	Weight <i>Peso</i> Kg/Mts	Perimeter <i>Perimetro</i> ext.	int.	total	Faces <i>Caras</i>	Jx cm. <sup>4</sup>	Jy c. <sup>4</sup>
4657*		EXTENSION PROFILE <i>PERFIL ALARGADERA</i>	0,344	19,7	---	19,7	1	0,02	9,42
5010		DOOR FRAME <i>MARCO PUERTA</i>	1,512	32,60	18,60	51,2	2	17,49	25,03
5011		FIXED FRAME AND JIGSAW SASH <i>MARCO FIJO Y HOJA VAIVEN</i>	1,430	30,3	18,7	49,0	2	16,75	25,03
5020		DOOR SASH INT. OPENING <i>HOJA PUERTA APERTURA INTERIOR</i>	1,655	38,8	18,6	57,4	2	17,36	36,79
5030		DOOR SASH EXT. OPENING <i>HOJA PUERTA APERTURA EXTERIOR</i>	1,652	39,2	18,6	57,8	2	22,00	30,94
5031		COLUMN <i>MONTANTE</i>	1,695	37,3	18,2	55,5	2	21,35	30,94
5040		COLUMN <i>MONTANTE</i>	1,398	26,4	18,3	44,7	2	17,65	16,35
5041		EXT. MULLION <i>MAINEL EXTERIOR</i>	1,378	25,2	19,6	44,8	2	16,31	17,75
5050		SKIRTING BOARD <i>ZOCALO</i>	2,461	48,2	34,4	82,6	2	39,67	199,09
5401		SKIRTING BOARD COMPLEMENT <i>SUPLEMENTO ZOCALO</i>	0,461	17,0	---	17,0		0,17	4,33
5402		BASE <i>PEANA</i>	0,315	14,1	---	14,1		0,06	1,14
5403		SWING <i>BATIENTE</i>	0,661	23,4	---	23,4	1	0,93	6,90

\* Consultar existencias o pedido mínimo



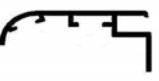
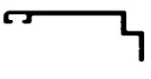
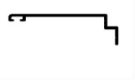
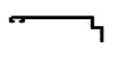
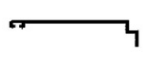
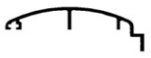

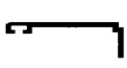
## Technical Data - *Datos técnicos*

Reference <i>Referencia</i>	Scheme <i>Esquema</i>	Description <i>Descripción</i>	Weight <i>Peso</i> Kg/Mts	Perimeter ext.	<i>Perimetro</i> int.	total	Faces <i>Caras</i>	Jx cm. <sup>4</sup>	Jy c. <sup>4</sup>
5404		MUNTIN <i>JUNQUILLO</i>	0,282	10,4	---	10,4	1	0,15	0,92
5405		FEMALE ADJUSTABLE CORNER <i>ESQUINERO REGULABLE HEMBRA</i>	1,436	25,0	22,6	47,7	2	9,93	17,95
5406		MALE ADJUSTABLE CORNER <i>ESQUINERO REGULABLE MACHO</i>	1,257	32,8	9,2	42,0	3	9,18	18,87
5407		JIGSAW DOOR COMPLEMENT <i>SUPLEMENTO PUERTA VAIVÉN</i>	0,762	22,0	---	22,0	2	0,40	12,48
72481		47 mm CURVED OVERLAP <i>SOLAPE CURVO DE 47 mm</i>	0,336	---	---	19,7	2	0,17	2,83
72701		33 mm OVERLAP <i>SOLAPE DE 33 mm</i>	0,199	---	---	11,7	1	0,06	1,20
72702		43 mm OVERLAP <i>SOLAPE DE 43 mm</i>	0,234	---	---	13,7	1	0,07	2,23
72703		60 mm OVERLAP <i>SOLAPE DE 60 mm</i>	0,333	---	---	17,4	1	0,10	5,48
72704		87 mm OVERLAP <i>SOLAPE DE 87 mm</i>	0,443	---	---	22,8	1	0,11	14,14
72708		60 mm CURVED OVERLAP <i>SOLAPE CURVO DE 60 mm</i>	0,428	---	---	21,4	1	0,36	6,73
72800*		33 mm SUPERIOR OVERLAP <i>SOLAPE SUPERIOR 33 mm</i>	0,200	---	---	10,9	1	0,07	0,92
72801		33 mm OVERLAP <i>SOLAPE DE 33 mm</i>	0,197	---	---	10,7	1	0,05	0,99

\* Consultar existencias o pedido mínimo

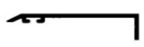

## Technical Data - *Datos técnicos*

Reference <i>Referencia</i>	Scheme <i>Esquema</i>	Description <i>Descripción</i>	Weight <i>Peso</i> Kg/Mts	Perimeter <i>Perimetro</i> ext.	Perimeter int.	Perimeter total	Faces <i>Caras</i>	Jx cm. <sup>4</sup>	Jy c. <sup>4</sup>
<b>72802</b>		45 mm OVERLAP <i>SOLAPE DE 45 mm</i>	0,195	---	---	12,3	1	0,03	1,52
<b>72803</b>		37 mm OVERLAP <i>SOLAPE DE 37 mm</i>	0,259	---	---	14,4	1	0,11	1,31
<b>72804</b>		38 mm OVERLAP <i>SOLAPE DE 38 mm</i>	0,251	---	---	13,6	1	0,11	1,47



o

o





