



ABISAGRADOS
HINGED

V-98

PERFILES | ACCESORIOS



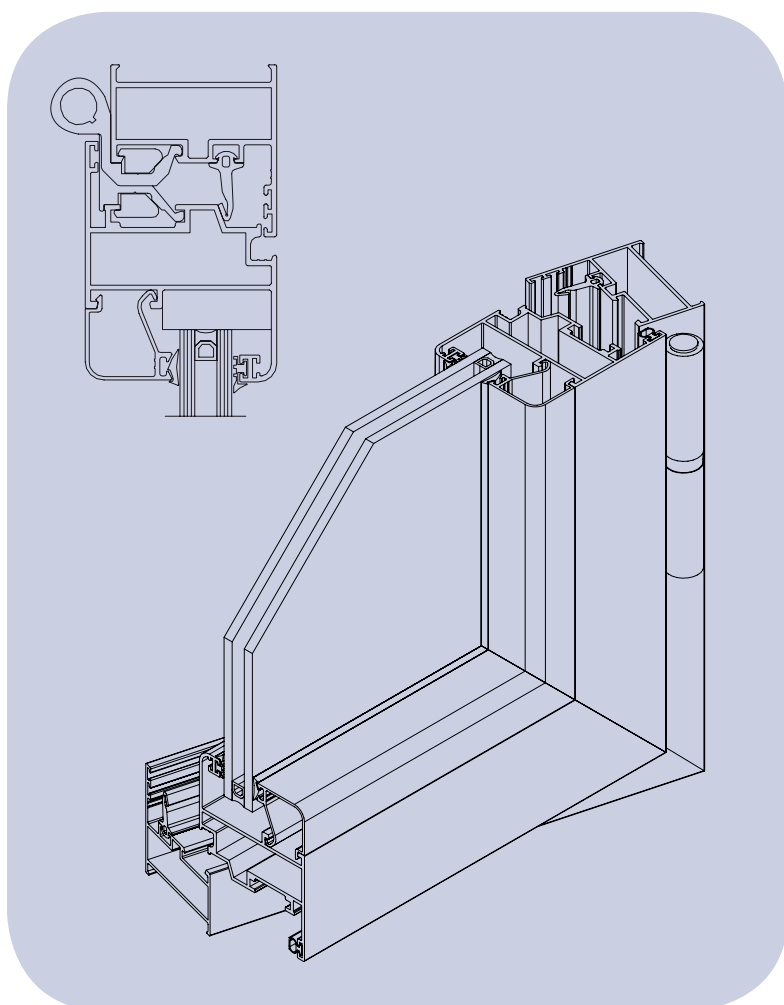

Características técnicas

SECCIÓN MARCO	SECCIÓN HOJA	ALT. GALCE VIDRIO	HUECO VIDRIO MÁX.	ESPESOR
45	52	20	38	1,4

Homologación

AIRE	AGUA	VIENTO	TÉRMICA	ACÚSTICA RW
4	9A	C4	4,00 W/m ² K	34 dB

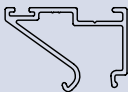
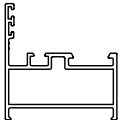
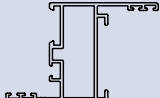
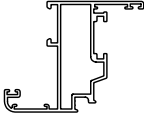
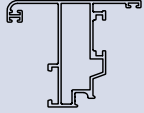
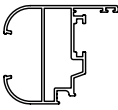
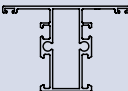
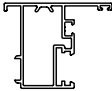
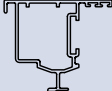

PERFILES | PROFILES

Referencia Reference	Esquema Scheme	Descripción Description
9820415		SUPLEMENTO ZÓCALO SKIRTING BOARD SUPPLEMENT
9821410		MARCO VENTANA WINDOW FRAME
9821412		MARCO CON SOLAPE FRAME WITH OVERLAP
9821420		HOJA VENTANA WINDOW SASH
9821423		H. PUERTA APER. EXT. DOOR SASH EXT. OPENING
9821426		HOJA AJUNQUILLADA MUNTIN SASH
9821430		TRAVESAÑO VENTANA WINDOW TRANSOM
9821440		PERFIL INVERSOR INVERTER PROFILE
9822740		PIVOTANTE PIVOTING



PERFILES | PROFILES

Referencia Reference	Esquema Scheme	Descripción Description
9823210		MARCO PUERTA C/32 DOOR FRAME C/32
9823216		MARCO ESCAPARATE SHOWCASE FRAME
9823220		HOJA PUERTA C/32 DOOR SASH C/32
9823223		H. PUERTA APER. EXT. DOOR SASH EXT. OPPENING
9823224		PIVOTANTE PIVOTING
9823230		TRAVESAÑO PUERTA DOOR TRANSOM
9823232		TRAVESAÑO REFORZADO REINFORCED TRANSOM
9823233		PARTELUCES MULLION
9824020		HOJA CÁMARA 40 APERTURA INTERIOR CHAMBER SASH 40 INT. OPPENING



PERFILES | PROFILES

Ref: 9820415

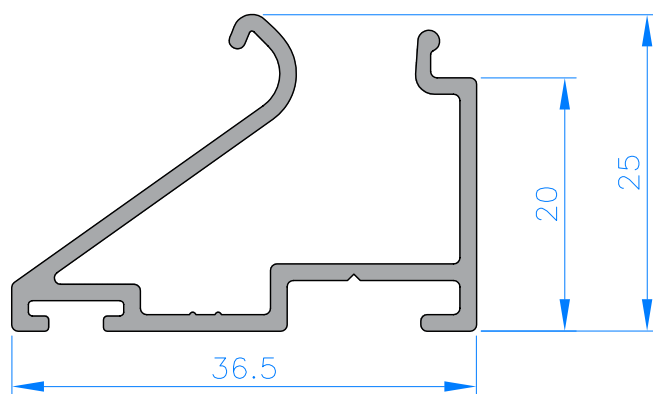

Ref: 9821410

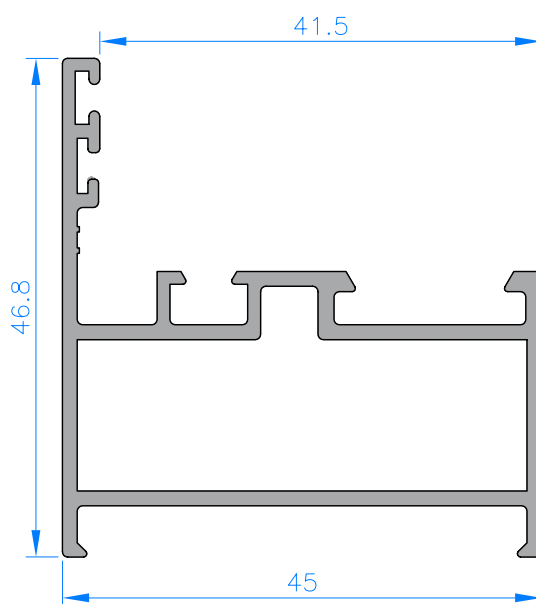



PERFILES | PROFILES

Ref: 9821412

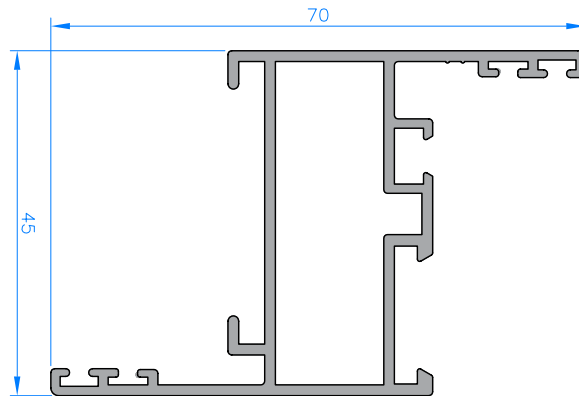

Ref: 9821420

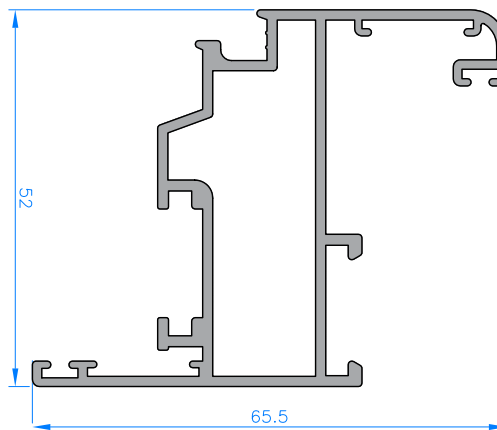

Ref: 9821423

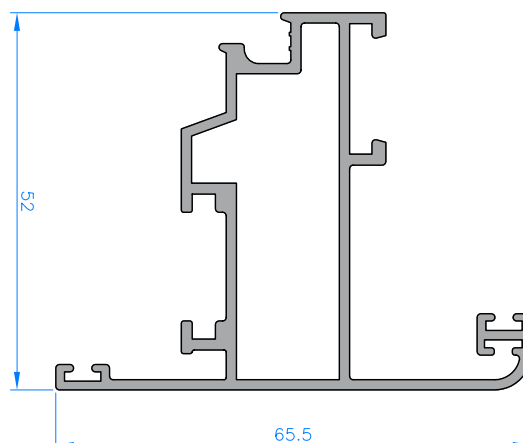



PERFILES | PROFILES

Ref: 9821426

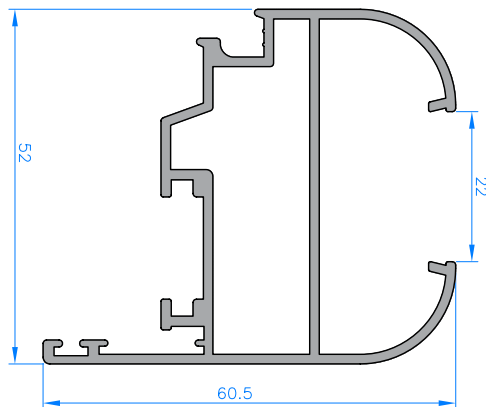

Ref: 9821430

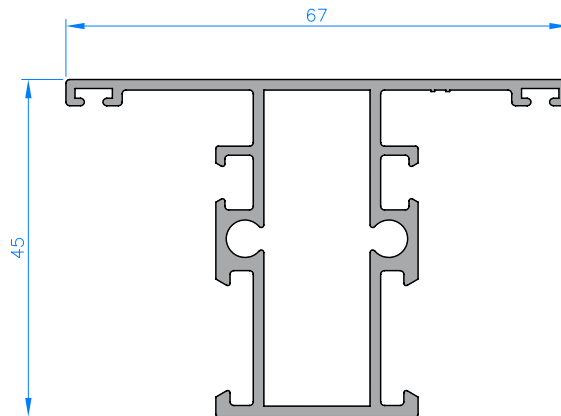

Ref: 9821440

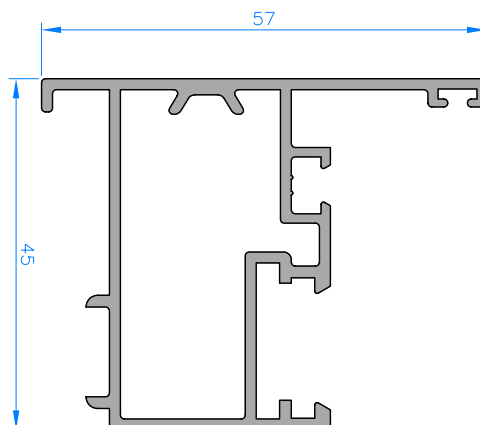



PERFILES | PROFILES

Ref: 9822740

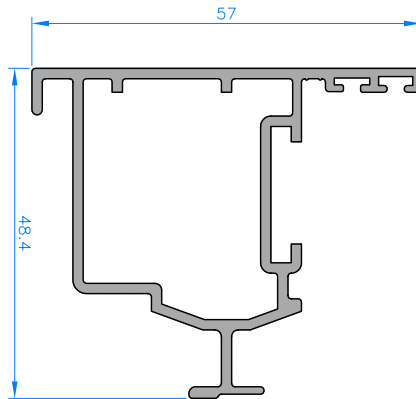

Ref: 9823210

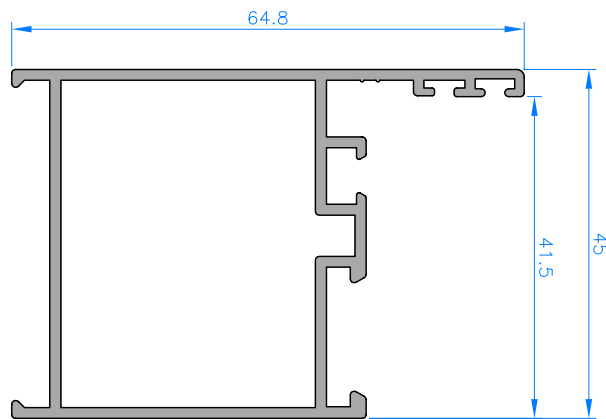

Ref: 9823216

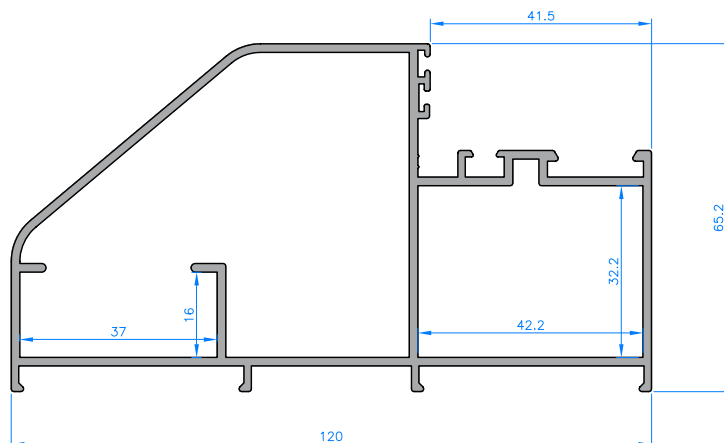



PERFILES | PROFILES

Ref: 9823220

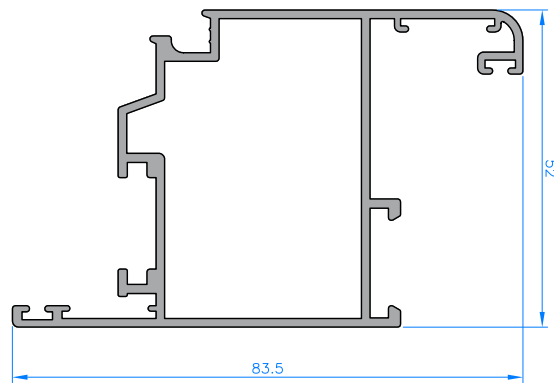

Ref: 9823223

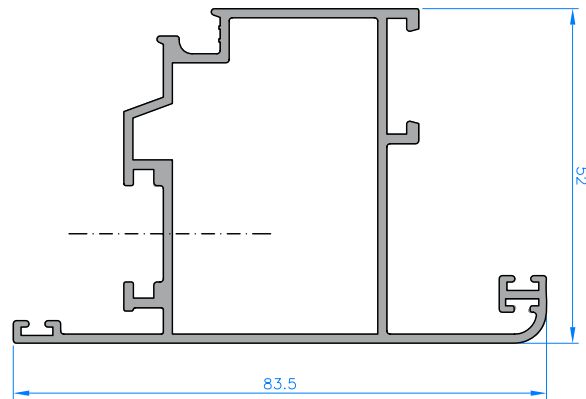

Ref: 9823224

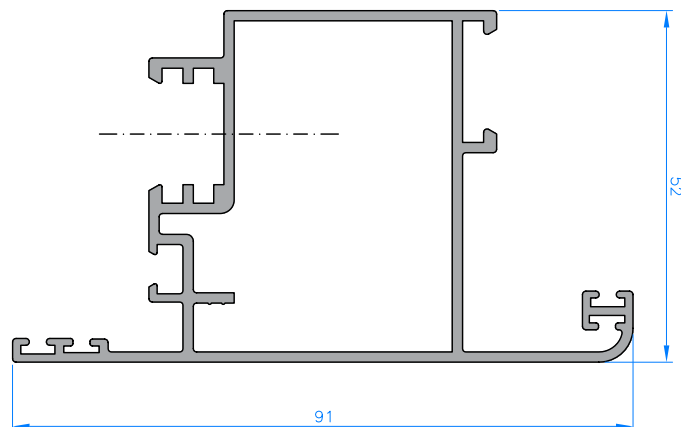



PERFILES | PROFILES

Ref: 9823230

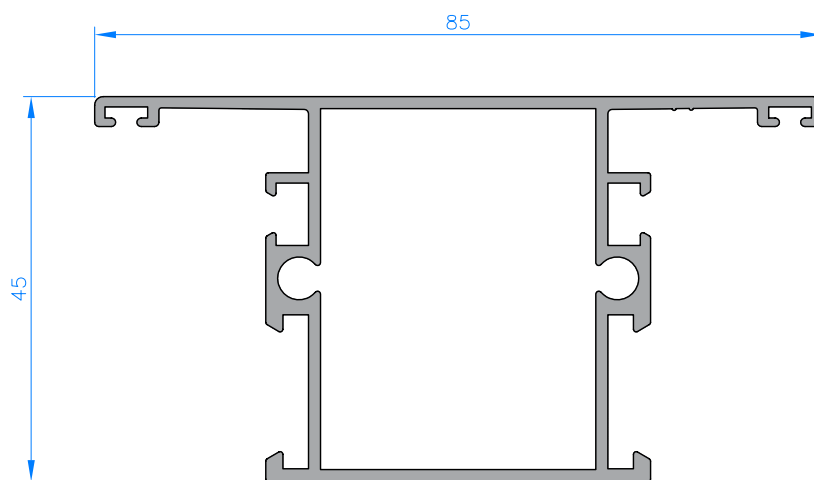

Ref: 9823232

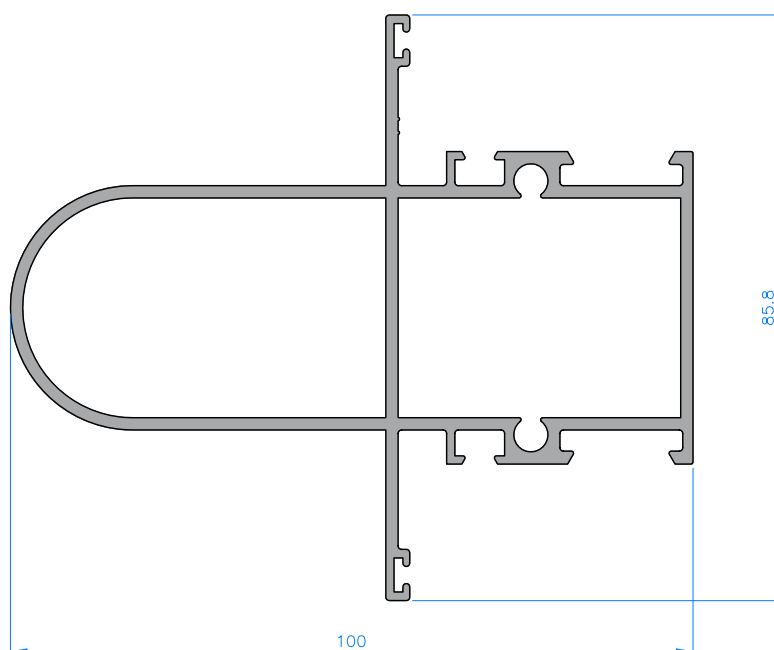



PERFILES | PROFILES

Ref: 9823233

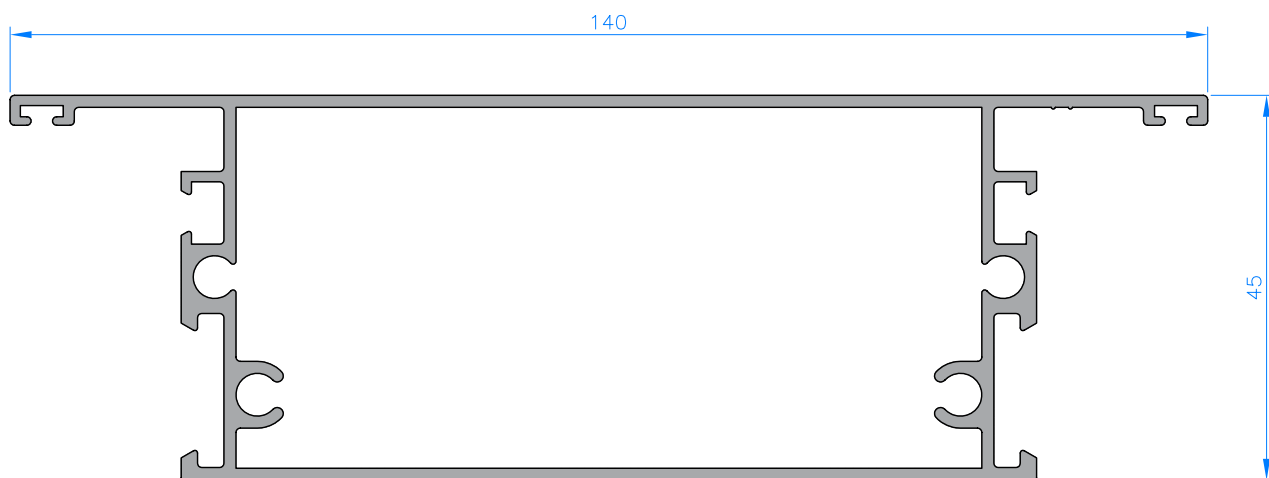

Ref: 9824020

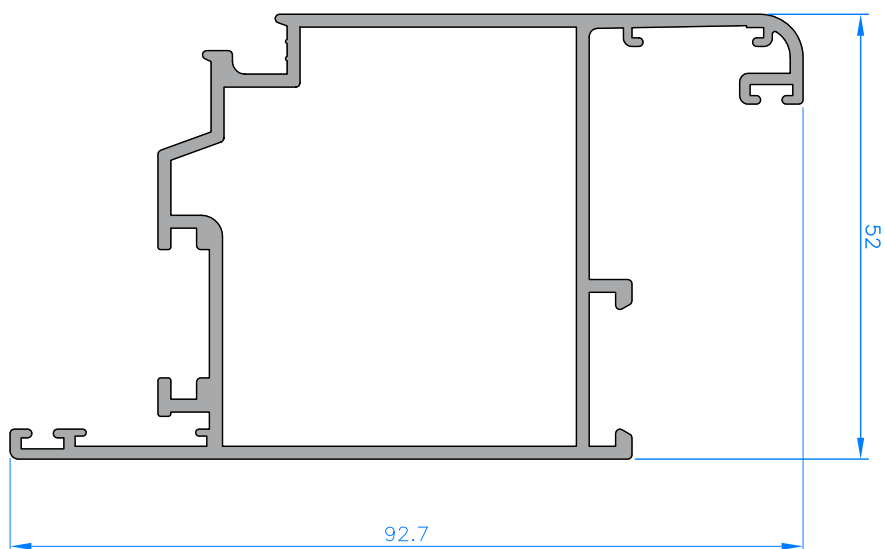







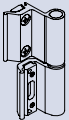
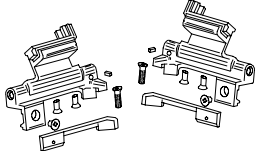

ACCESORIOS | ACCESSORIES

Código Code	Figura Drawing	Descripción Description
0940103		ESC.JUNTA CENT.VULCAN V-94 / V-98 /V-98RT55 CENTRAL JOINT BRACKETS
0980141		ESCUADRA EUROPEA VENTANA 42X14 T-8 SERIE V-98 EUROPEAN BRACKET 42X14 T-8 V-98 SERIES
0980261		ESCUADRA 26X27 INVERSOR PIVOTANTE SERIE V-98 26X27 BRACKET PIVOTING INVERTER V-98 SERIES
0980321		ESCUADRA EUROPEA BALCONERA 42X32 T-8 SERIE V-98 BALCONY EUROPEAN BRACKET 42X32 T-8 V-98 SERIES
0980401		ESCUADRA EUROPEA BALCONERA 42X40 T-8 SERIE V-98 BALCONY EUROPEAN BRACKET 42X40 T-8 V-98 SERIES
0980511		ESCUADRA ANGULO VARIABLE DE 14X42 PARA V-98 14X42 VARIABLE ANGLE BRACKET FOR V-98
0940705		ESCUADRA ALINEAMIENTO INOX. STAINLESS ALIGNMENT BRACKETS
0980705		ESCUADRA ALINEAM. HOJA INOX STAINLESS ALIGN.BRACKETS
0982141		UNION EUROPEA 14X18 EUROPEAN JOINT 14X18
0982321		UNION EUROPEA 32X18 EUROPEAN JOINT 32X18

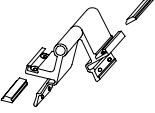

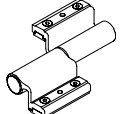
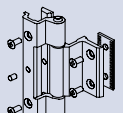

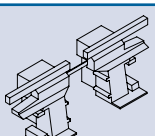

ACCESORIOS | ACCESSORIES

Código Code	Figura Drawing	Descripción Description
0942401		BISAGRA SOBREPUESTA EUROPEA DCHA.-IZDA. EUROPEAN OVERLAPPING HINGE RIGHT-LEFT
0942421		JUEGO BISAGRA 2ª HOJA O. B. PRISMA HINGE 2ND SASH BALANCE PRISMA
0942601		BISAGRA 3ª HOJAS C.E. 3rd SASH HINGE EUROPEAN CHANNEL
0942651		BISAGRA 4 HOJAS C.E. 4 SASH HINGE EUROPEAN CHANNEL
0943203		GRAPA JUNQUILLO CURVO CURVED MUNTIN STAPLE
0942721		BISAGRA DE PUERTA C.E. DOOR HINGE EUROPEAN CHANNEL
0942731		BISAGRA TRES CUERPOS C.E. THREE BODIES HINGE EUROPEAN CHANNEL
0943113		SALIDA DE AGUA WATER EXIT
0983123		JUEGO TAPAS INVERSOR V-98 Y V-98RT/45 INVERTER CAPS

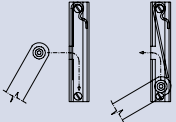
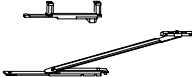



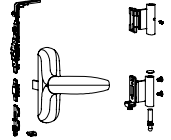
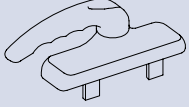
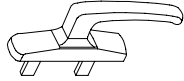
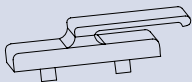
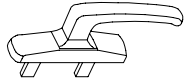

ACCESORIOS | ACCESSORIES

Código Code	Figura Drawing	Descripción Description
0943431		JUEGO COMPAS ABATIBLE DESMONTABLE REMOVABLE ABATIBLE COMPAS
0943441		COMPAS SUPLEMENTARIO O.B. SUPPLEMENTARY BALANCE COMPAS
0943450		COMPAS SUPER REDUCIDO O.B. SUPER REDUCED BALANCE COMPAS
0943460		COMPAS CORTO O.B. SHORT BALANCE COMPAS
0980401		COMPAS NORMAL O.B. NORMAL BALANCE COMPAS
0943500		KIT OSCIOBATIENTE PRISMA DUE C.E. BALANCE PRISMA DUE EUROPEAN CHANNEL KIT
0944012		CREMONA 2 PALAS PRACTICABLE C.E. 2 BLADES HANDLE EUROPEAN CHANNEL
0944032		CREMONA APERTURA EXTERIOR EXT. OPENNING HANDLE
0944042		CREMONA P/4 HOJAS PLANA DERECHA-IZQUIERDA FLAT HANDLE P/4 SASH R-L
0944062		MANETA APERTURA EXTERIOR FLEXIFIN CUADRADILLO DE 7 MM X 70 DE LARGO EXT. OPENNING HANDLE FLEXIFIN SQUARE NUT 7MM X 70MM LONG

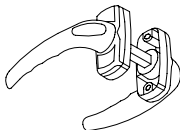
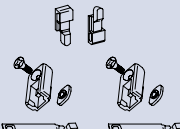
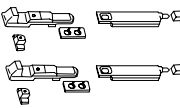
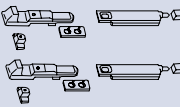

ACCESORIOS | ACCESSORIES

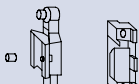
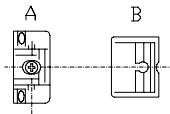
Código Code	Figura Drawing	Descripción Description
0944072		CREMONA APERTURA EXTERIOR CON PALAS REGULABLES DERECHA-IZQUIERDA EXT. OPENING HANDLE WITH ADJUST. FINS R-L
0944412		MANILLA FLEXIPOR FLEXIPOR HANDLE
0946513		KIT 1 HOJA PRACTICABLE 1 SASH KIT PRACTICAL
0946533		KIT 2ª HOJA PASIVA 2ND SASH KIT PASSIVE
0946542		KIT 2ª HOJA PASADOR O. B.C/EXCENT. REGULABLE 2ND SASH KIT BALANCE PIN
0946553		KIT APERTURA EXTERIOR EXT. OPENING KIT
0946564		MECANISMO BIDIRECCIONAL PARA APERTURA EXTERIOR BIDIRECTIONAL MECHANISM FOR EXT. OPENNING
0946712		CIERRE SUPLEMENTARIO VERTICAL SUPPLEMENTARY VERTICAL LOCKING
0946722		CIERRE SUPLEMENTARIO HORIZONTAL ANTIPALANCA SUPPLEMENTARY HORIZONTAL LOCKING ANTILEVER
0946742		CIERRE REGUL.3 PTO. LADO BISAGRAS V-94 ADJUSTABLE LOCKING 3 POINTS HINGE SIDE



ACCESORIOS | ACCESSORIES

Código Code	Figura Drawing	Descripción Description
0858076		JUNTA BATIENTE CASEMENT JOINT
0948076		JUNTA BATIENTE HOJA SASH CASEMENT JOINT
0948106		JUNTA CENTRAL V94/V98 MARCO CENTRAL JOINT V94/V98 FRAME
0948126		GOMA INFERIOR ZOCALO PUERTA INF. RUBBER DOOR SKIRTING BOARD
0858206		JUNTA ACRISTALAMIENTO EXTERIOR DE 5 MM 5 MM EXT. GLAZING JOINT
0948206		JUNTA EXTERIOR MARCO SERIES V-94 Y V-98 BASE 4.7 FRAME EXT. JOINT
1028206		JUNTA ACRISTALAMIENTO EXT. ALETA DE 3 MM. 3 MM FIN EXT. GLAZING JOINT
0858216		JUNTA EXTERIOR MARCO DE PRESION PRESSURE FRAME EXT. JOINT
1028326		JUNTA ACRISTALAMIENTO INT. ALETA DE 3 MM 3 MM FIN INT. GLAZING JOINT



HUECO PARA CRISTAL | SPACE FOR CRYSTAL

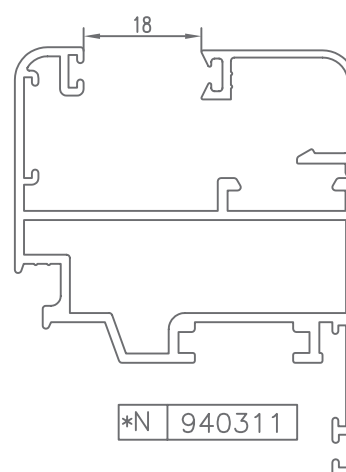
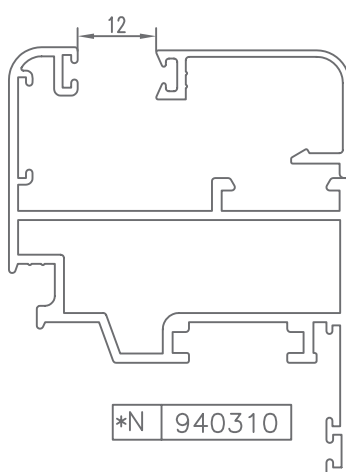
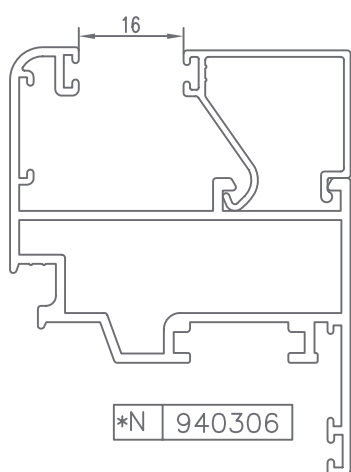
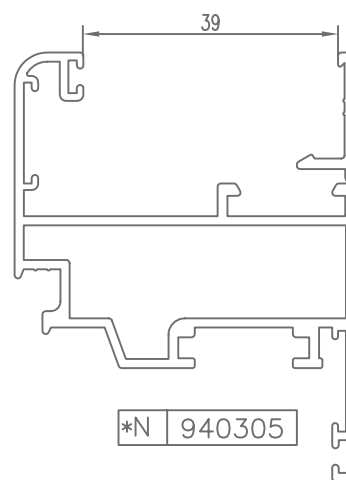
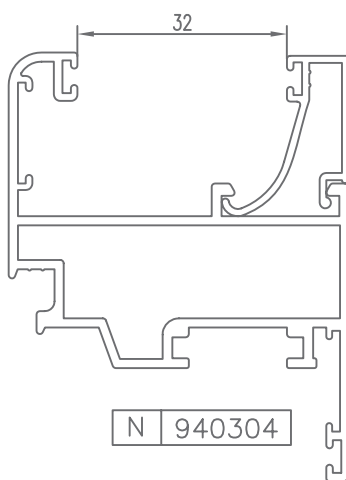
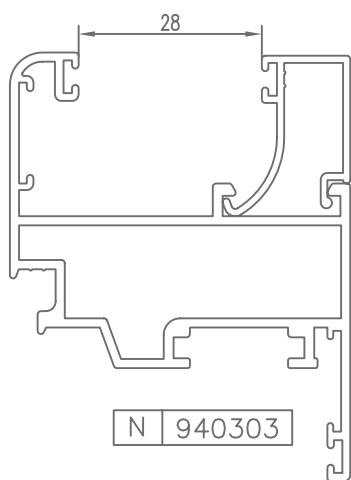
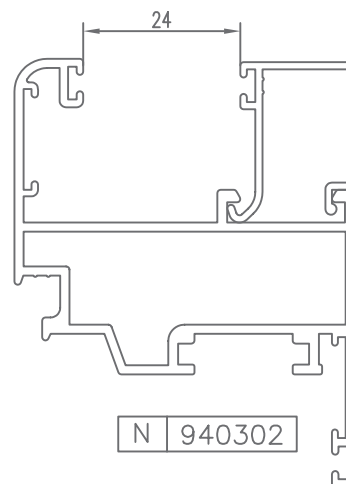
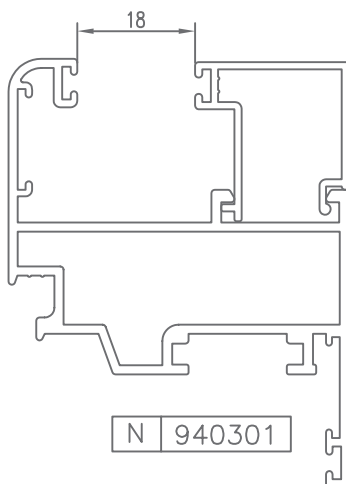
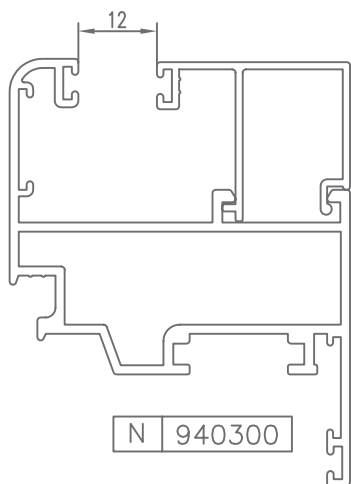

* CONSULTAR



HUECO PARA CRISTAL | SPACE FOR CRYSTAL

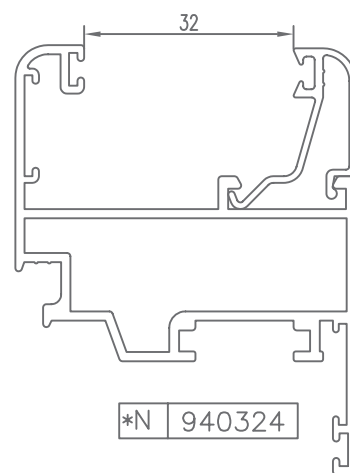
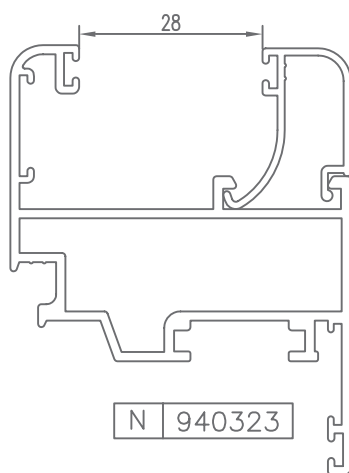
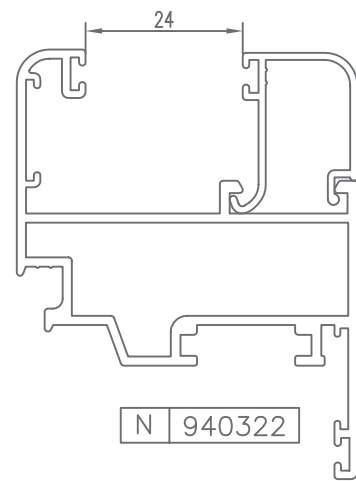
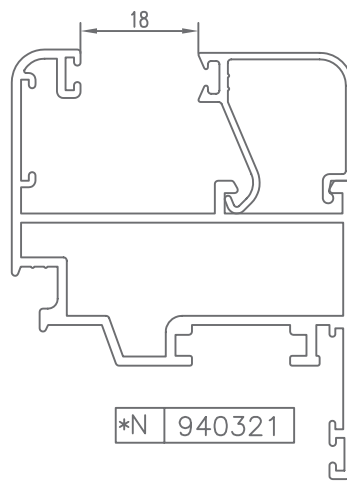
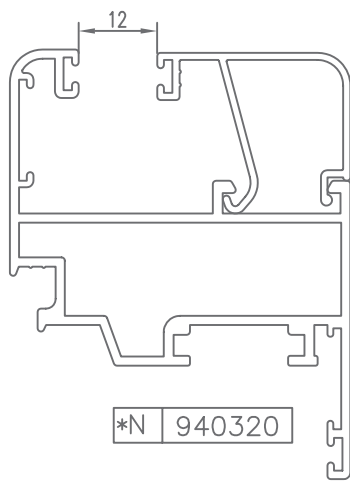
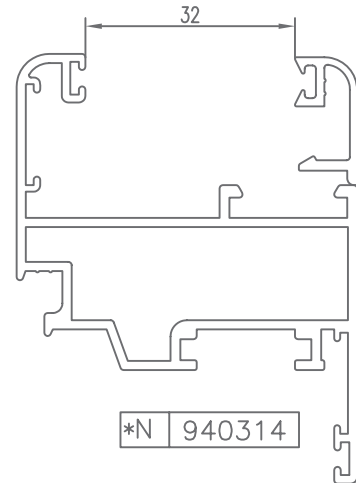
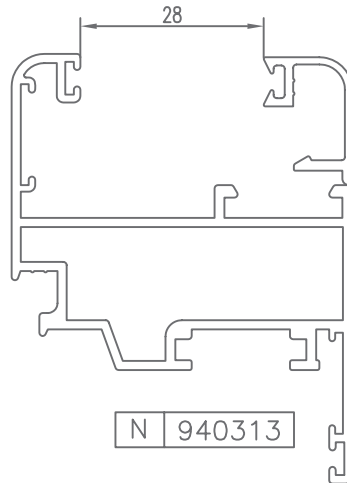
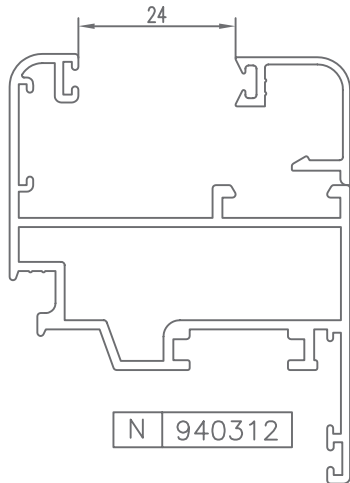

* CONSULTAR



HUECO PARA CRISTAL | SPACE FOR CRYSTAL

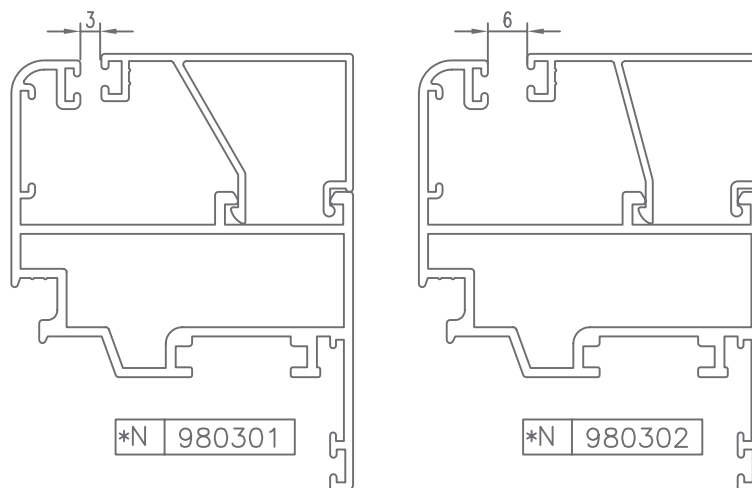

* CONSULTAR



HUECO PARA CRISTAL | SPACE FOR CRYSTAL

CÓDIGO	SECCIÓN	DESCRIPCIÓN	HUECO
940300		Junquillo cabeza 29,5 mm.	12 mm.
940301		Junquillo cabeza 23,5 mm.	18 mm.
940302		Junquillo cabeza 17,5 mm.	24 mm.
940303		Junquillo cabeza 13,5 mm.	28 mm.
940304		Junquillo cabeza 9,5 mm.	32 mm.
*940305		Junquillo grapa cabeza 2,6 mm.	39 mm.
*940306		Junquillo cabeza 25,5 mm.	16 mm.
*940310		Junquillo curvo grapa cabeza 29,5 mm.	12 mm.
*940311		Junquillo curvo grapa cabeza 23,5 mm.	18 mm.
940312		Junquillo curvo grapa cabeza 17,5 mm.	24 mm.
940313		Junquillo curvo grapa cabeza 13,5 mm.	28 mm.

* CONSULTAR



HUECO PARA CRISTAL | SPACE FOR CRYSTAL

CÓDIGO	SECCIÓN	DESCRIPCIÓN	HUECO
*940314		Junquillo curvo grapa cabeza 9,5 mm.	32 mm.
*940320		Junquillo curvo cabeza 29,5 mm.	12 mm.
*940321		Junquillo curvo cabeza 23,5 mm.	18 mm.
940322		Junquillo curvo cabeza 17,5 mm.	24 mm.
940323		Junquillo curvo cabeza 13,5 mm.	28 mm.
*940324		Junquillo curvo cabeza 9,5 mm.	32 mm.
*980301		Junquillo cabeza 38,3 mm.	3 mm.
*980302		Junquillo cabeza 35,5 mm.	6 mm.

* CONSULTAR



**HIERROS
JÁTIVA**

CENTRAL

Pol.Ind. "La Vila" Parcela 5.
46819 / Novetlé / Valencia (Spain)
administracion@hierrosjativa.com

Tel.: 96 227 08 00
Fax.: 96 227 41 63
HIERRO: 678 255 770
ALUMINIO: 678 252 153

.....

DELEGACIÓN ALICANTE

Pol.Ind. I-8, Calle Catral
033330 / Crevillente / Alicante (Spain)
crevillente@hierrosjativa.com

Tel.: 96 540 45 61
Fax.: 96 540 46 45

.....

DELEGACIÓN ZARAGOZA

Alfredo Abad

alfredoberdusan@gmail.com
Tel.: 647 576 092